

THE LEGO® MINDSTORMS® EV3 IDEA BOOK



YOSHIHITO ISOGAWA

181 Simple Machines and Clever Contraptions

The LEGO® MINDSTORMS® EV3 Idea Book

THE LEGO[®] MINDSTORMS[®] EV3 IDEA BOOK

181 Simple Machines and Clever Contraptions

YOSHIHITO ISOGAWA



The LEGO® MINDSTORMS® EV3 Idea Book. Copyright © 2015 by Yoshihito Isogawa.

All rights reserved. No part of this work may be reproduced or transmitted in any form or by any means, electronic or mechanical, including photocopying, recording, or by any information storage or retrieval system, without the prior written permission of the copyright owner and the publisher.

Printed in China
First Printing

18 17 16 15 14 1 2 3 4 5 6 7 8 9

ISBN-10: 1-59327-600-1
ISBN-13: 978-1-59327-600-3

Publisher: William Pollock
Production Editor: Riley Hoffman
Cover Design: Beth Middleworth
Photographer: Yoshihito Isogawa
Author Photo: Sumiko Hirano
Developmental Editor: Tyler Ortman
Technical Reviewer: Sumiko Hirano
Proofreader: Fleming Editorial Services

For information on distribution, translations, or bulk sales, please contact No Starch Press, Inc. directly:
No Starch Press, Inc.
245 8th Street, San Francisco, CA 94103
phone: 415.863.9900; info@nostarch.com
www.nostarch.com

Library of Congress Cataloging-in-Publication Data

Isogawa, Yoshihito, 1962-
The LEGO Mindstorms EV3 idea book : 181 Simple Machines and Clever Contraptions / Yoshihito Isogawa.
pages cm
ISBN 978-1-59327-600-3 -- ISBN 1-59327-600-1
1. Machinery--Models. 2. LEGO Mindstorms toys. I. Title.
TJ248.I86 2015
621.8022'8--dc23

2014027048

No Starch Press and the No Starch Press logo are registered trademarks of No Starch Press, Inc. Other product and company names mentioned herein may be the trademarks of their respective owners. Rather than use a trademark symbol with every occurrence of a trademarked name, we are using the names only in an editorial fashion and to the benefit of the trademark owner, with no intention of infringement of the trademark.

LEGO®, MINDSTORMS®, the brick and knob configurations, and the minifigure are trademarks of the LEGO Group, which does not sponsor, authorize, or endorse this book.









The information in this book is distributed on an "As Is" basis, without warranty. While every precaution has been taken in the preparation of this work, neither the author nor No Starch Press, Inc. shall have any liability to any person or entity with respect to any loss or damage caused or alleged to be caused directly or indirectly by the information contained in it.

Production Date: 8/5/14
Plant & Location: Printed by Everbest Printing (Guangzhou, China), Co. Ltd
Job / Batch #: 42088-0 / 703189

Contents

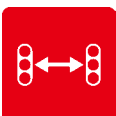
Introduction 1

PART 1 • Basic Mechanisms

	Gear ratios 4
	Compound gear systems 18
	Changing the angle of rotation 22
	Using worm drives 30
	Swinging mechanisms 36
	Reciprocating mechanisms 42
	Cam mechanisms 48
	Intermittent motion 52
	Transmitting rotation with rubber bands 56
	Transmitting rotation with caterpillar treads 60



Transmitting rotation over a long distance 62



Off-center axes of rotation 64



Changeover mechanisms using rotational direction 68



Universal joints 74

PART 2 • Vehicles



Driving wheels with a motor 78



Driving wheels with two motors 82



Caster wheels 90



Crawlers 94



Suspended wheels 100



Steering 104

PART 3 • Moving Without Tires



Walking machines 110



Moving like an inchworm 122



Moving through vibration 126

PART 4 • Arms, Wings, and Other Movements



Flapping wings 130



Gripping fingers 140



Lifting things 152



Shooting things 158



Automatic doors 168



Raking up or out 176



Creating wind 180



Swinging a pendulum 184



Using attachments to change motion 188



Meshing gears diagonally 194



Changing the angle of rotation freely 198

PART 5 • Sensors



Ideas for using the touch sensor 206



Ideas for using the buttons of the Intelligent EV3 Brick 214



Ideas for using the color sensor 216

PART 6 • Something Extra



Using the Pythagorean theorem 220



Try building something handy! 222

Introduction

The LEGO MINDSTORMS EV3 set is designed to allow builders of any age to create robots, vehicles, and other contraptions with moving parts.

Each model in this book is only a small mechanism, but you can make an infinite variety of larger models by combining these ideas. LEGO bricks aren't designed to fit in just one specific place or in one particular way. Your imagination is your guide when building with LEGO, and I hope that you will create your own wonderful masterpieces using this book as inspiration.

To build the models in this book, all you need is the LEGO MINDSTORMS EV3 set (home edition #31313).

Where Are the Words?

Other than this brief introduction and the table of contents, this book has almost no words. Instead, you'll find a series of photographs of increasingly complex models, each designed to demonstrate a mechanical principle or building technique.

While the book lists the pieces needed for each model, it does not include step-by-step building instructions. Look at the photographs taken from various angles and try to reproduce the model. Building in this way is something like putting together a puzzle. You'll get the hang of it after a little practice.

This is an idea book; it's about imagination. Rather than tell you what to see or think when you study the models, I encourage you to interpret them in your own way. Your interpretations will lead you to invent your very own models or use my mechanisms in entirely new ways!

What About Programs?

This book is about exploring the mechanical side of EV3 and robotics, rather than programming. You'll need only a few simple programs to test out your mechanical creations. Prepare these three simple programs in advance.

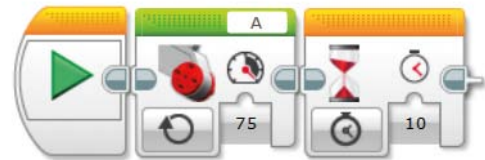

This program will rotate the Large EV3 motor, then rest for a period.

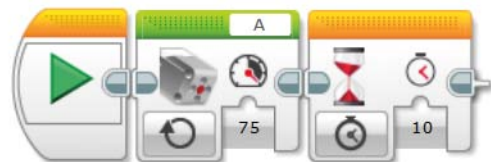

This program will rotate the Medium EV3 motor, then rest for a period.

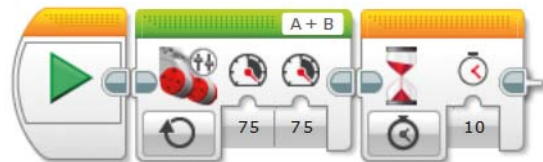

This program will rotate two motors, then rest for a period.

A few of the models in this book require special programs. Take note of these programs, as they are written to avoid damaging parts by overextending a mechanism's range of motion.

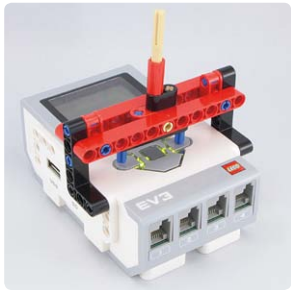

PART 1

● ○ ○ ○ ○ ○

Basic Mechanisms

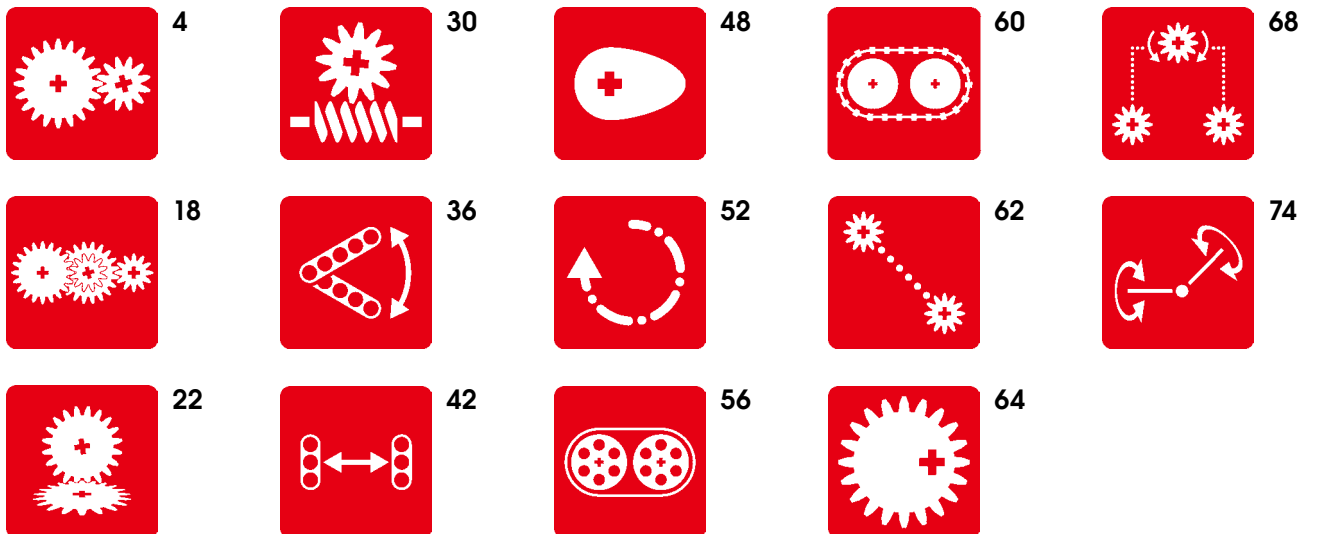

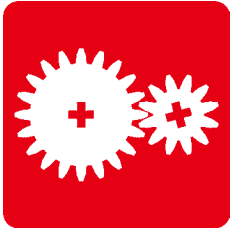

Gear ratios

#1

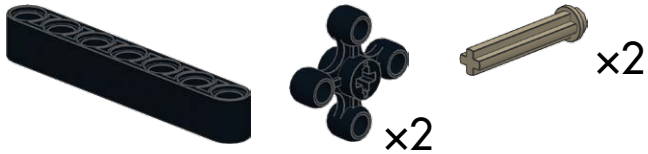

#2

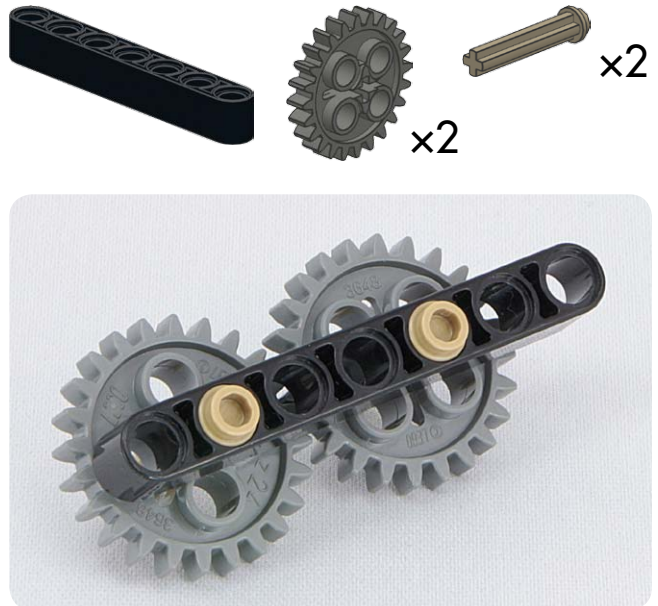

#3

36:36 = 1:1



#4

20:20 = 1:1

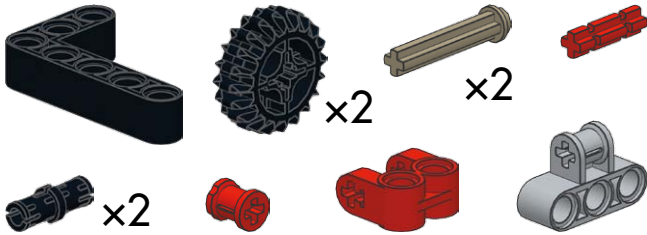

#5

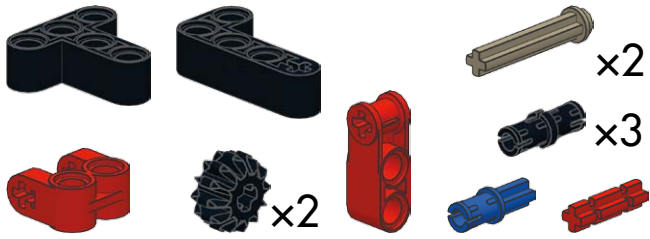

#6

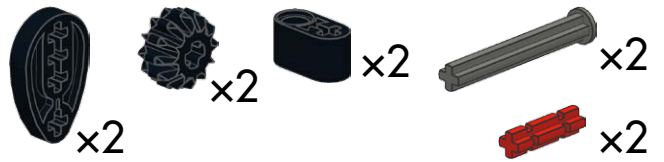

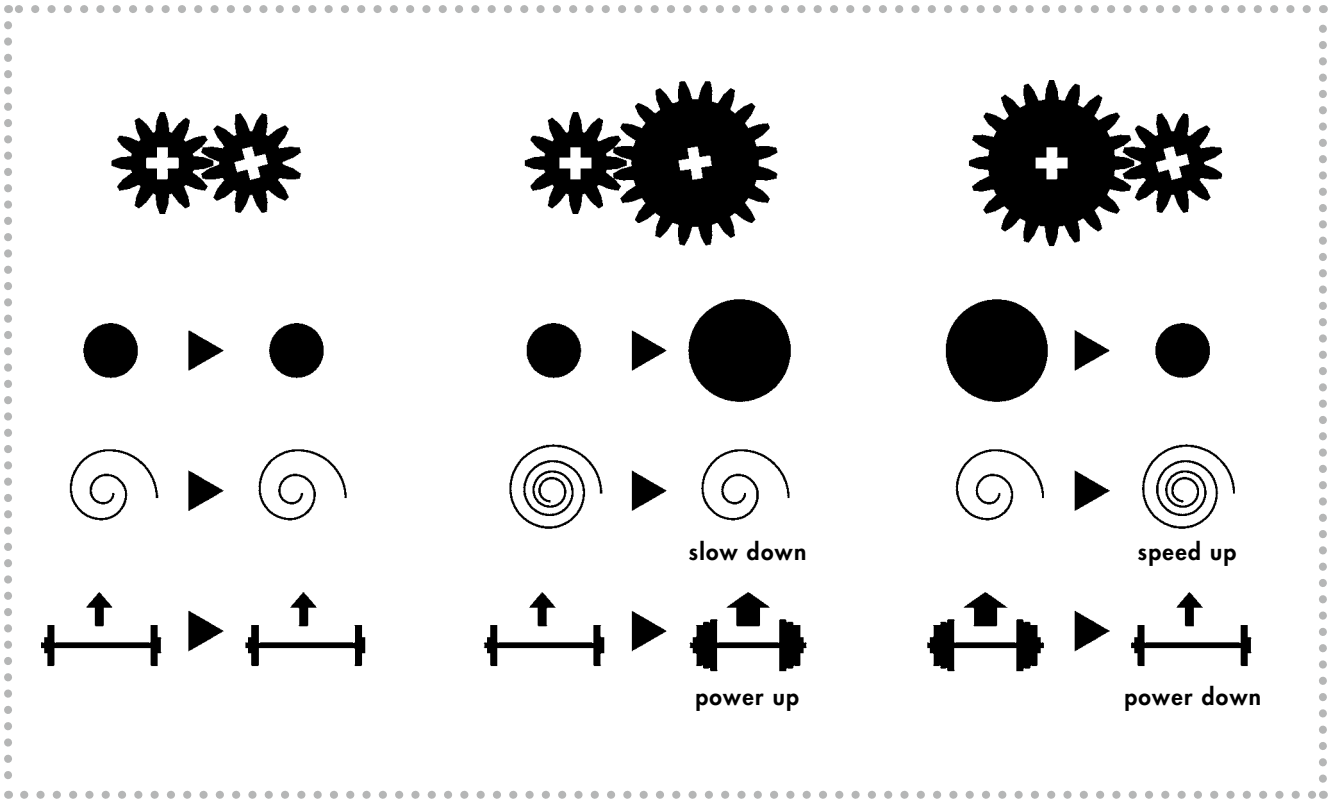

#7

$$12:20 = 3:5$$

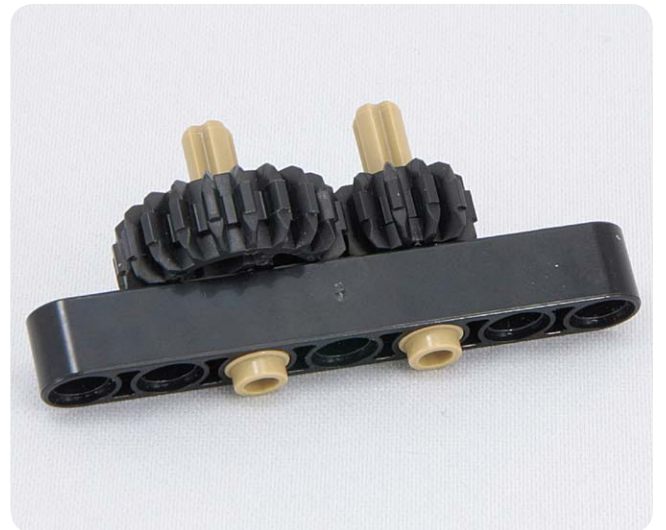

#8

12:24 = 1:2

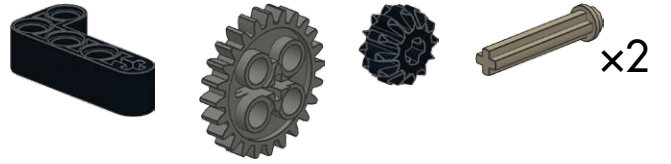

#9

12:36 = 1:3



#10



#11



#12

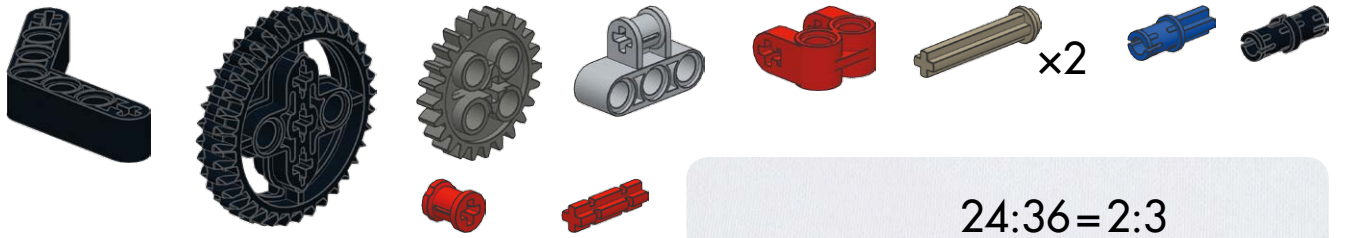

$$24:36 = 2:3$$



#13

$$12:20:12 = 3:5:3$$



#14

20:12:20 = 5:3:5

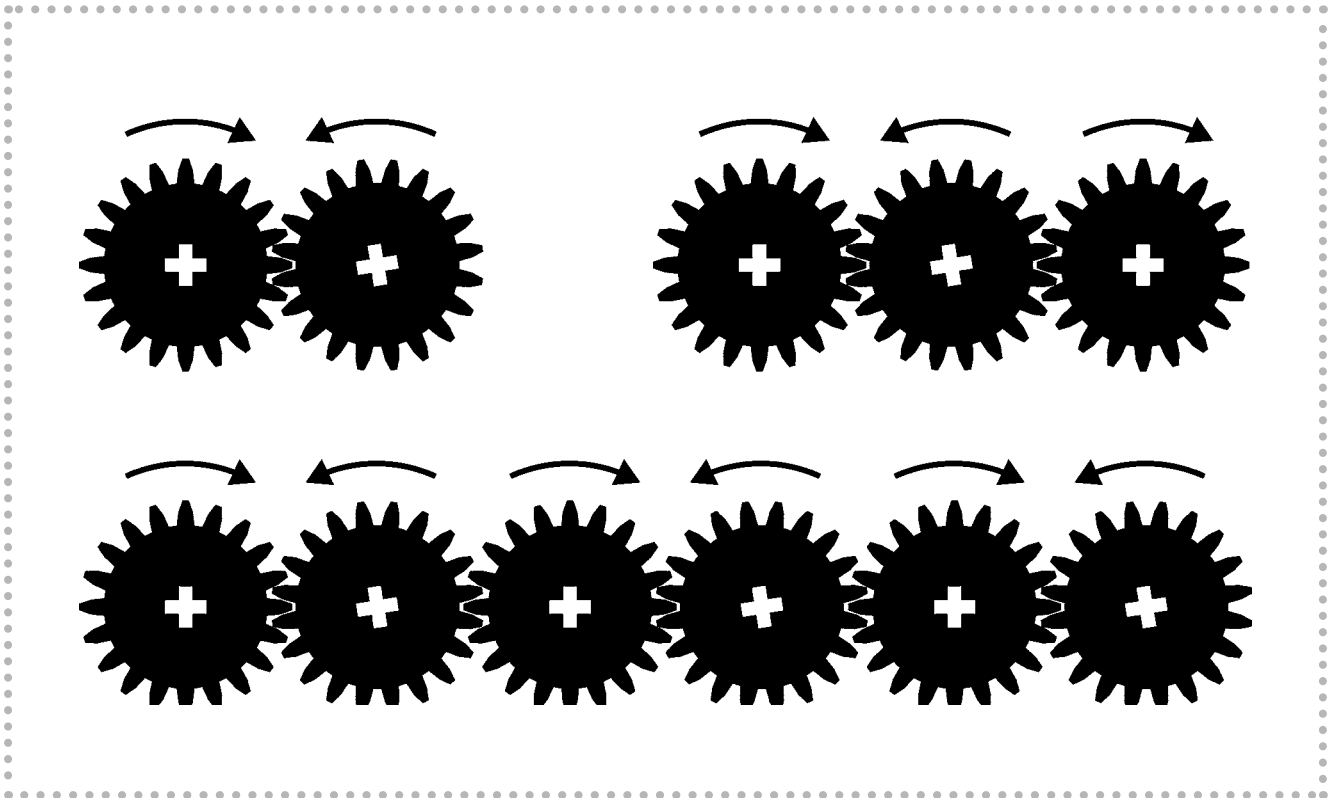

#15



#16

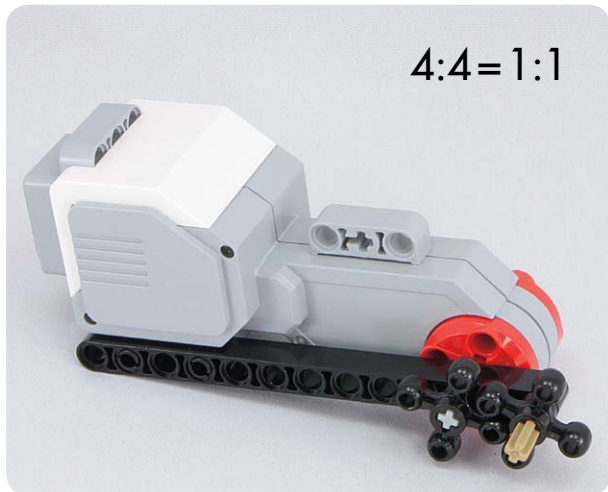
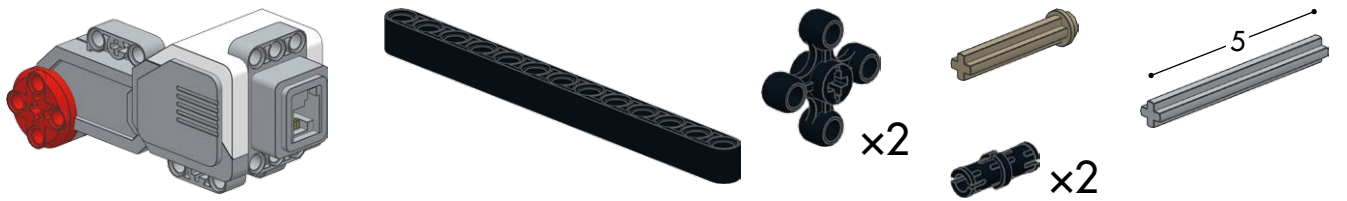

#17

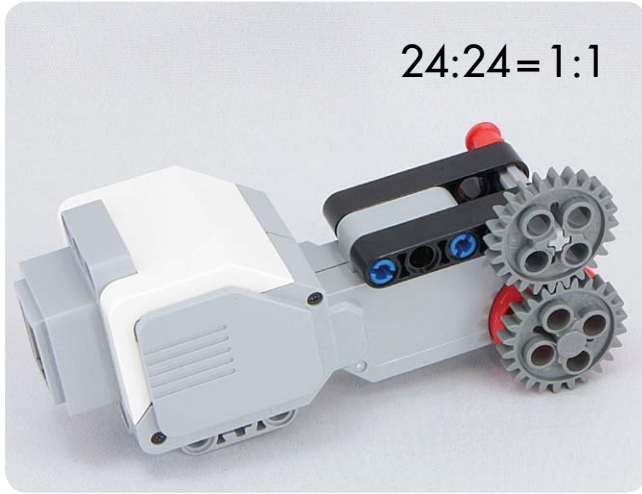

#18



#19

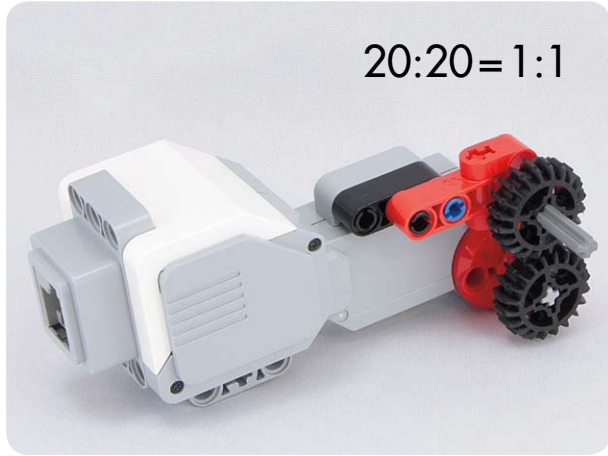
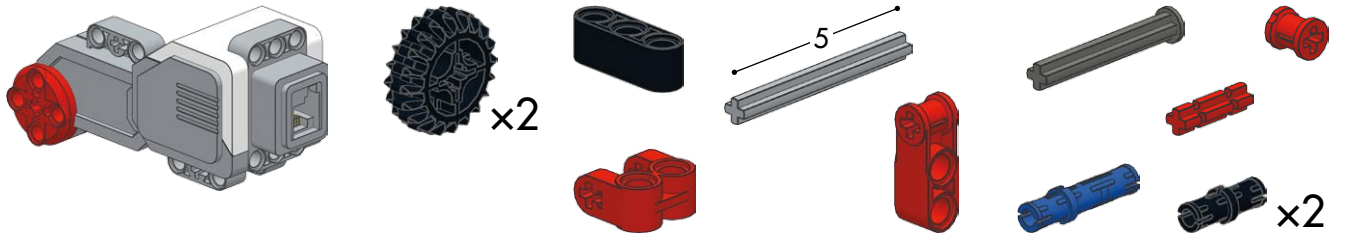

#20

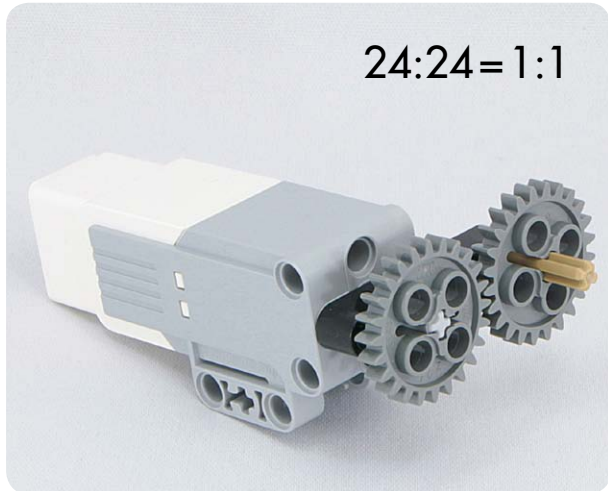

#21

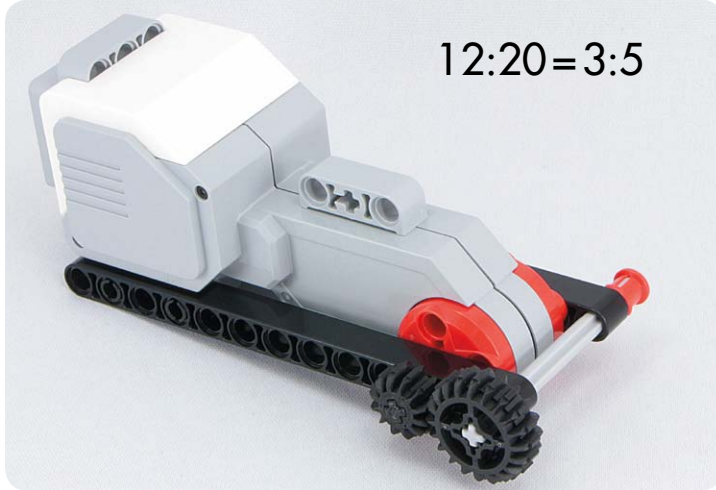
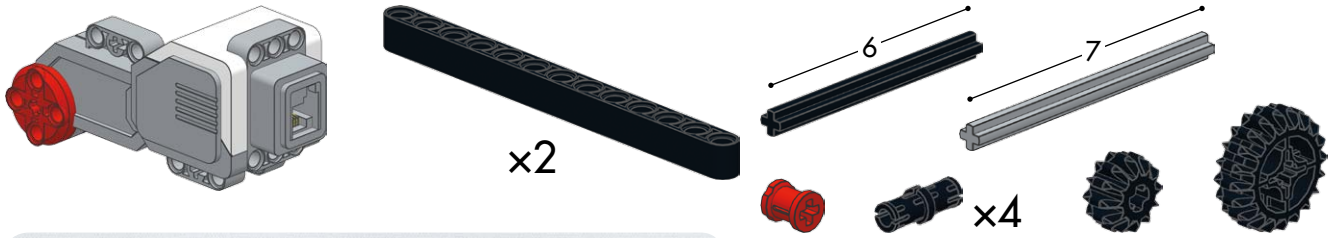

#22



#23



#24

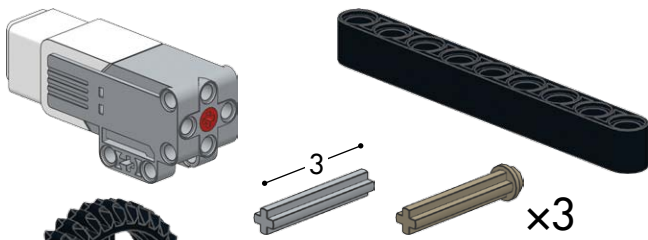

#25

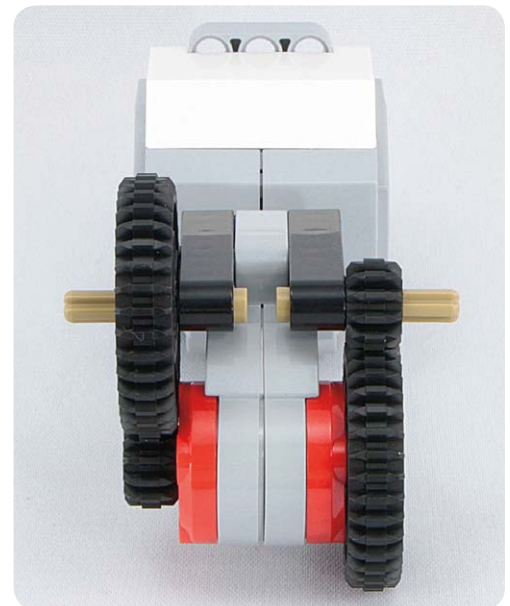
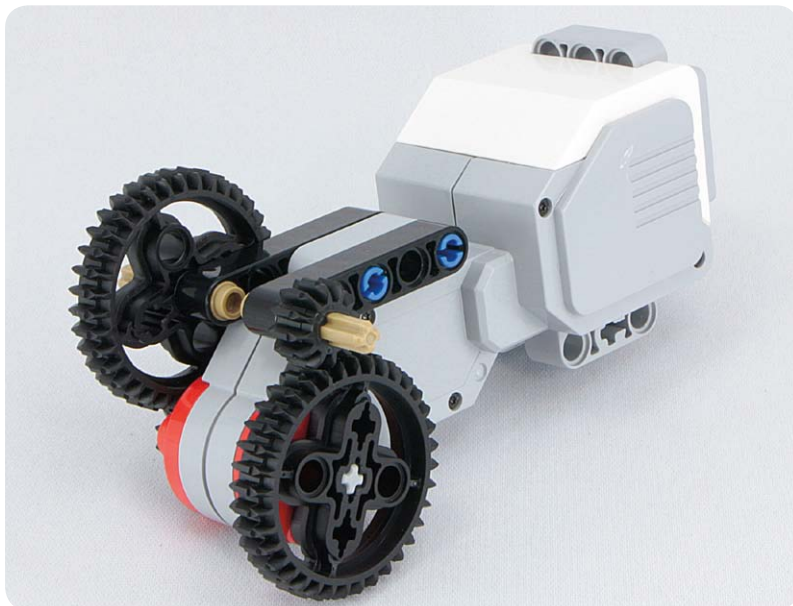
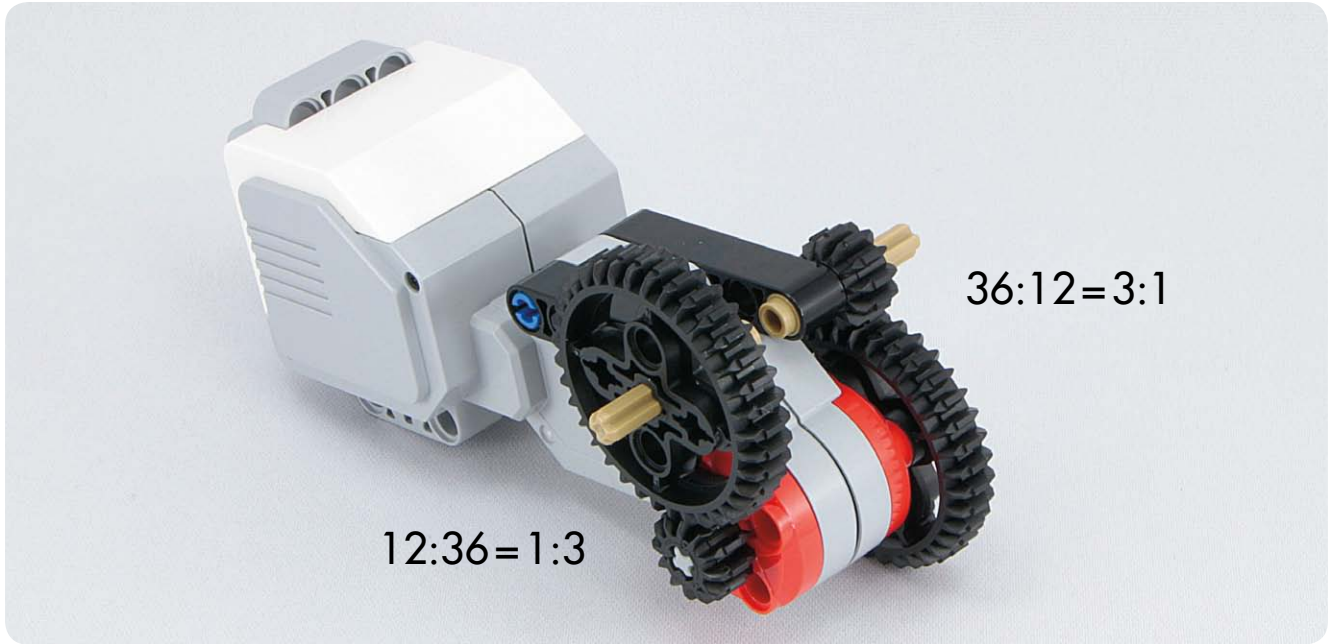
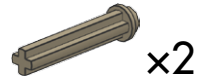
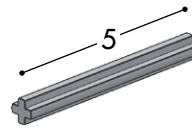
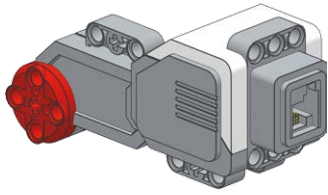

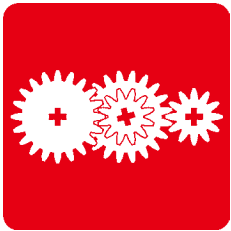

Compound gear systems

#26



#27

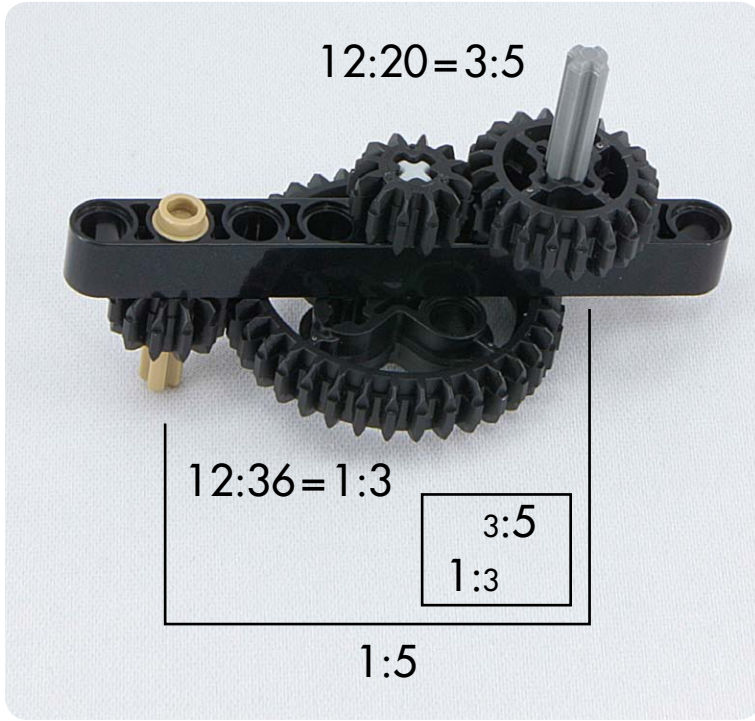

#28

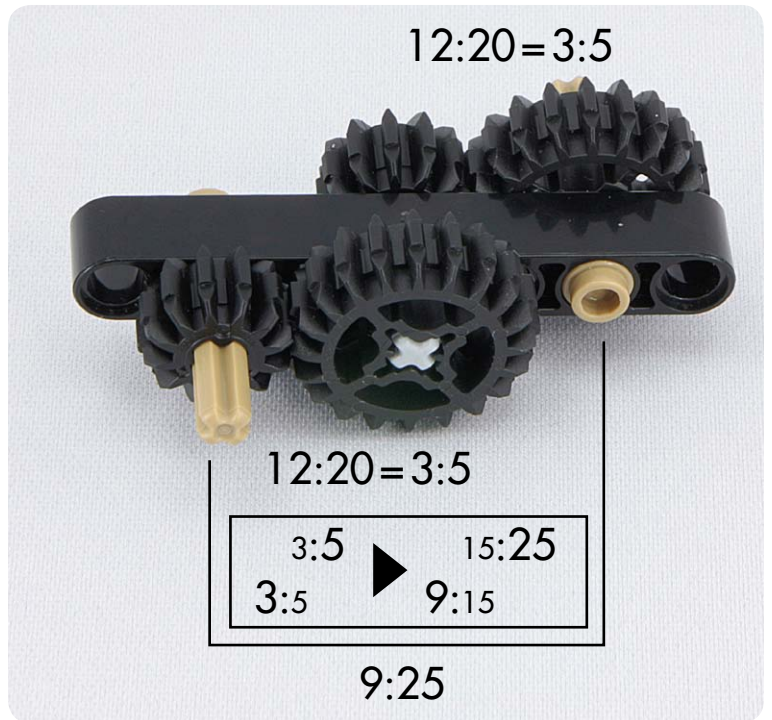
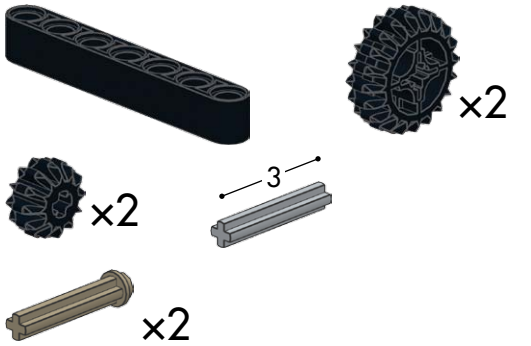

#29

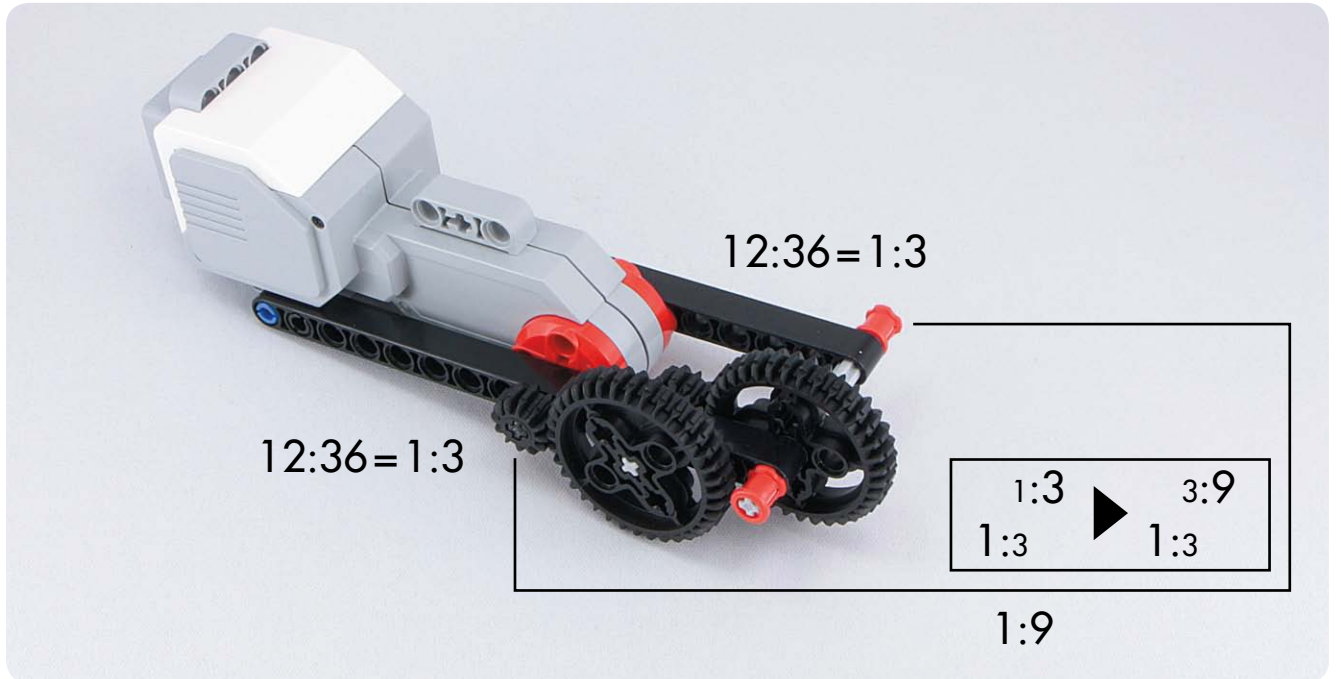
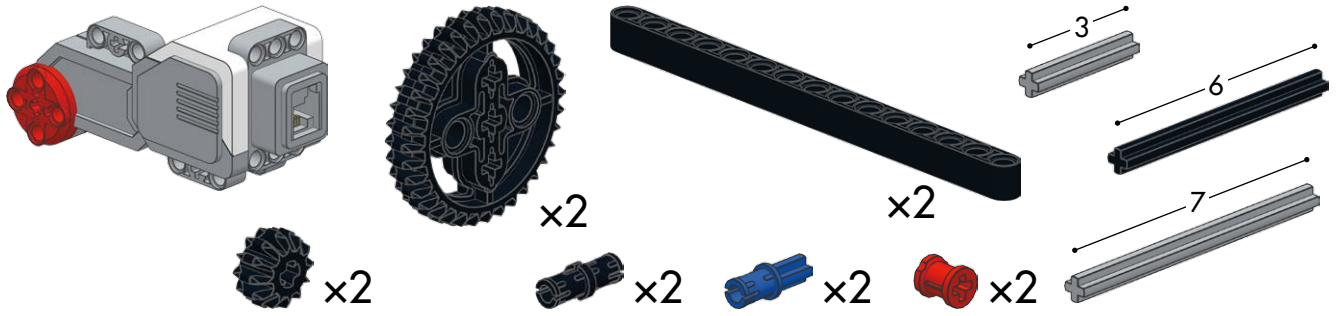

#30

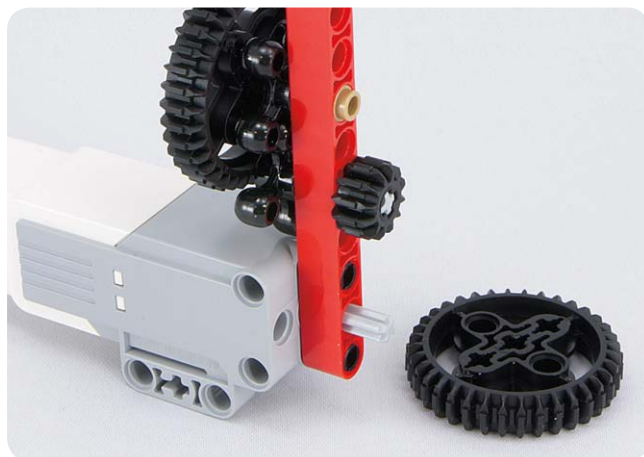
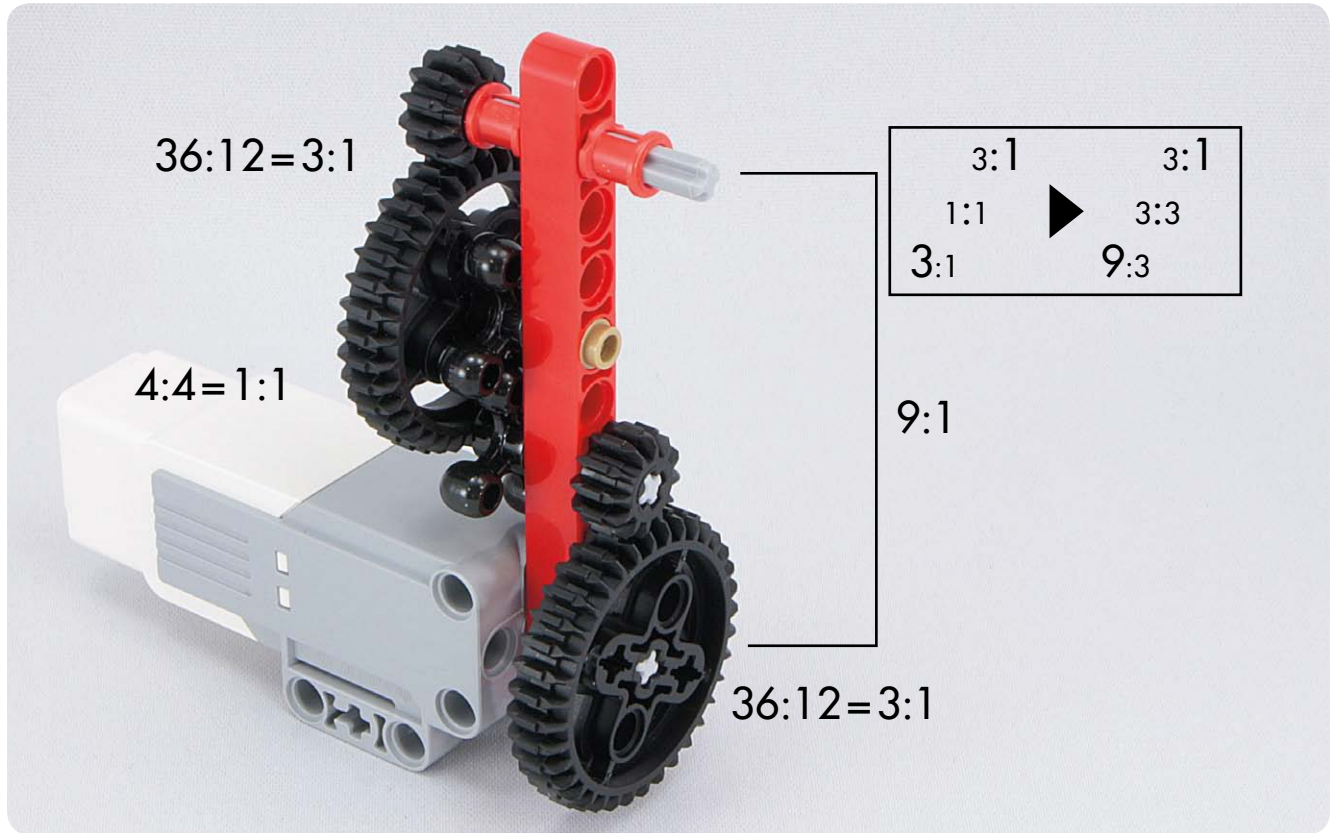
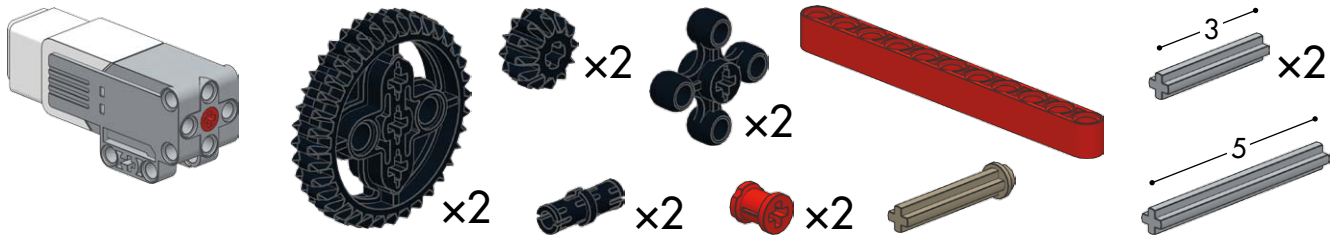



Changing the angle of rotation

#31



#32

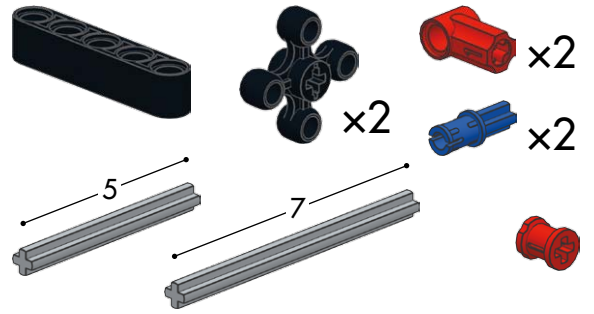

#33



#34



#35

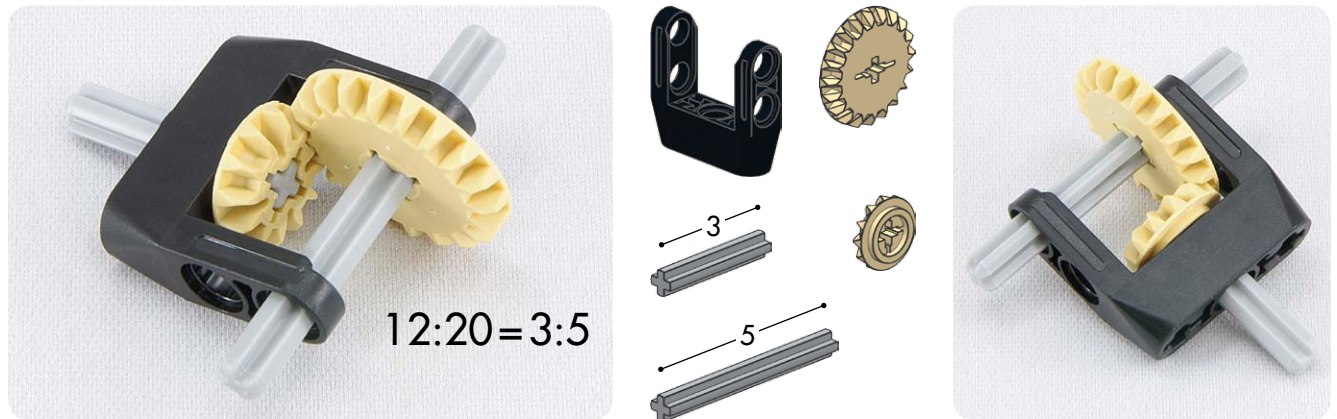

#36



#37

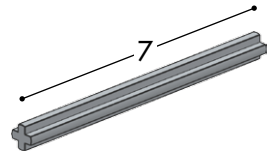
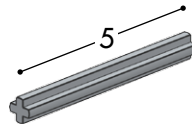
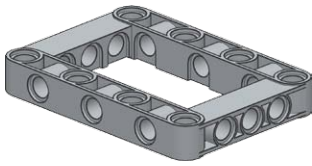

#38

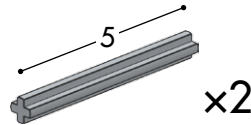

#39

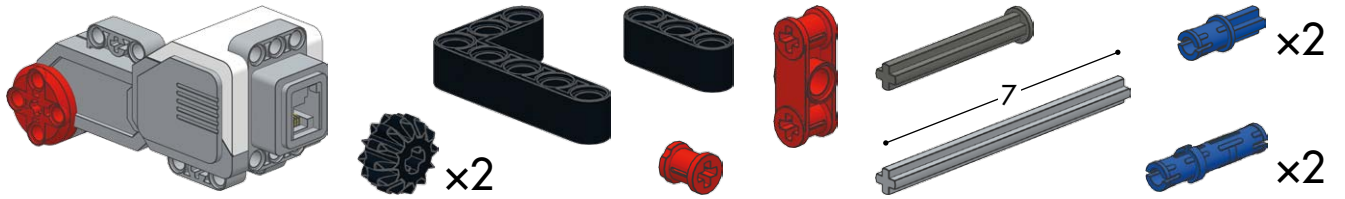

#40

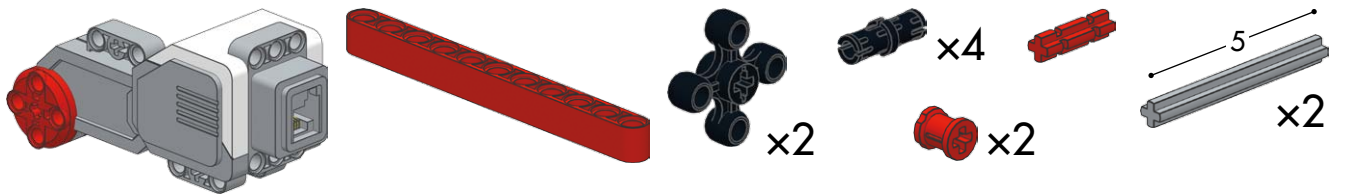

#41

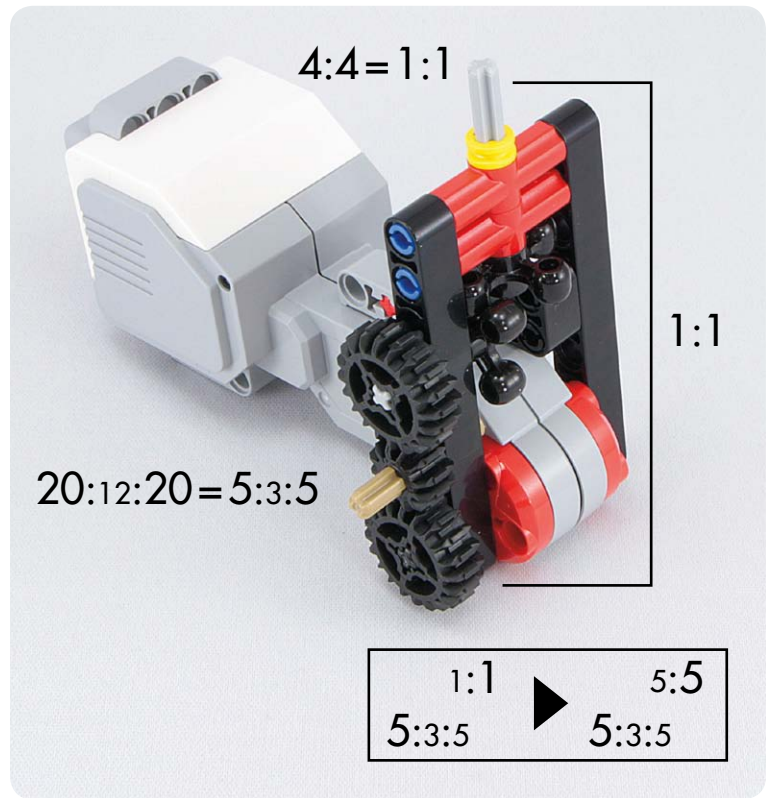
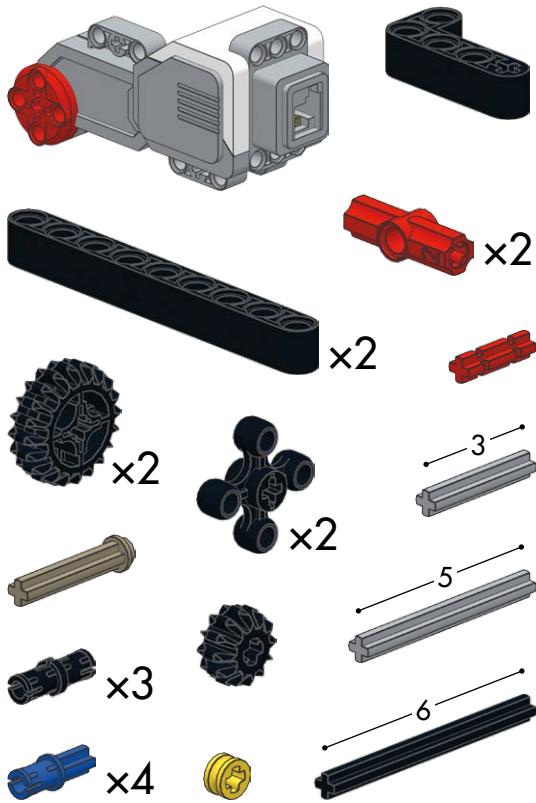

#42

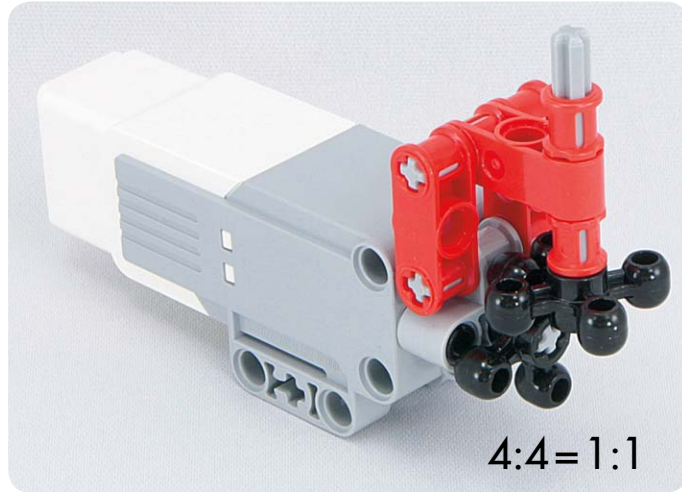
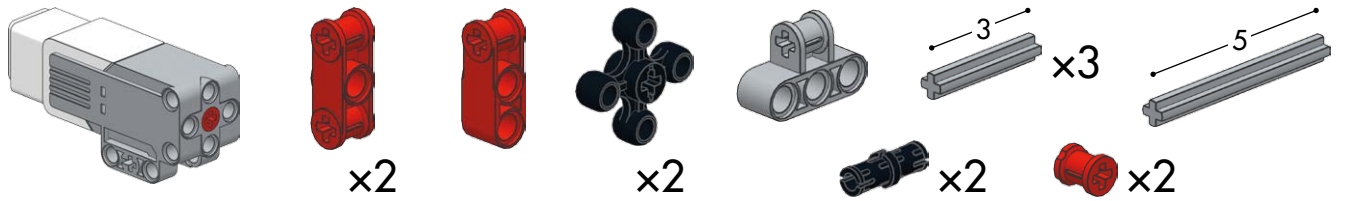

#43



#44

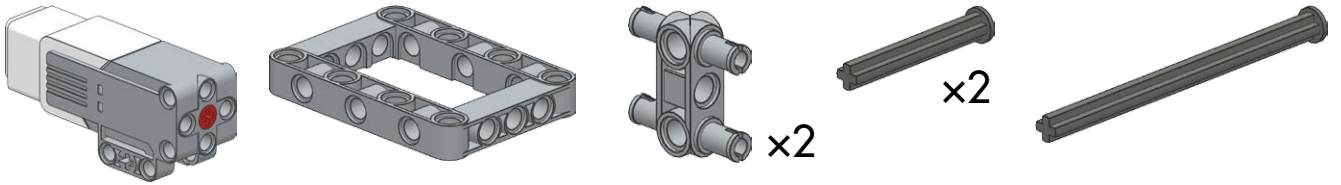

x2



x2



x2



x2

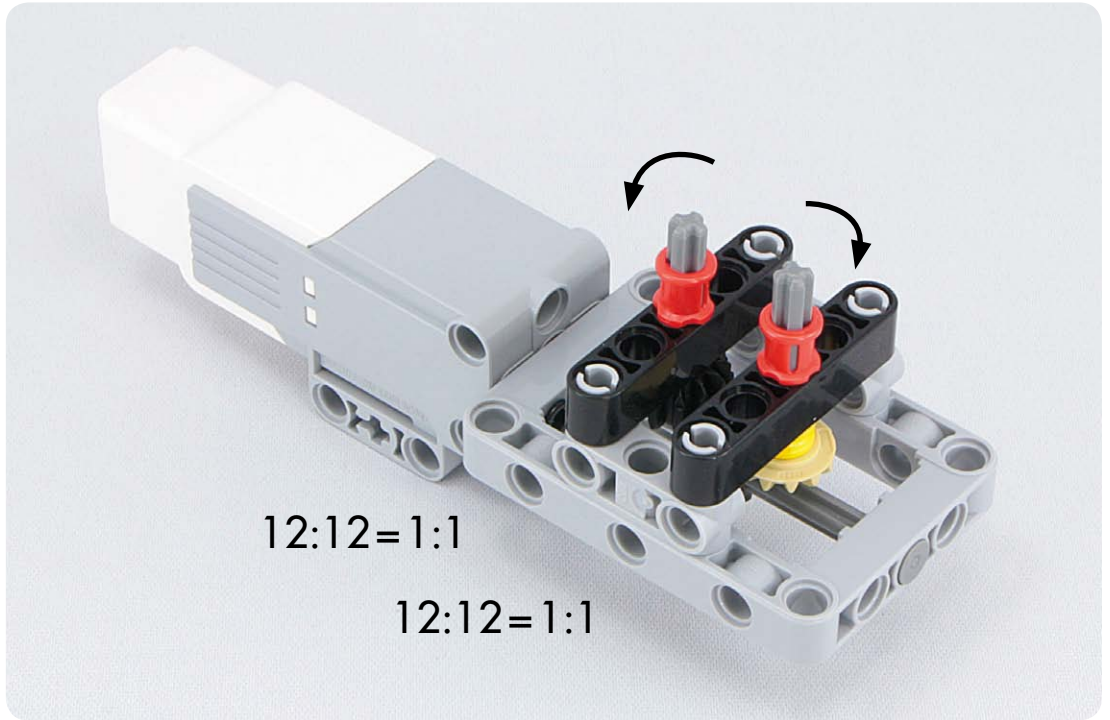

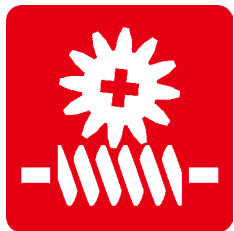





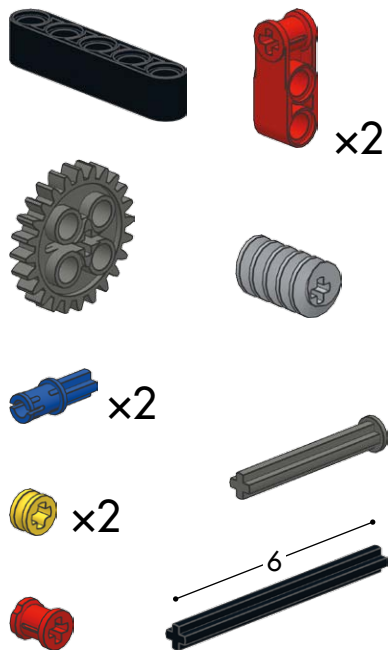

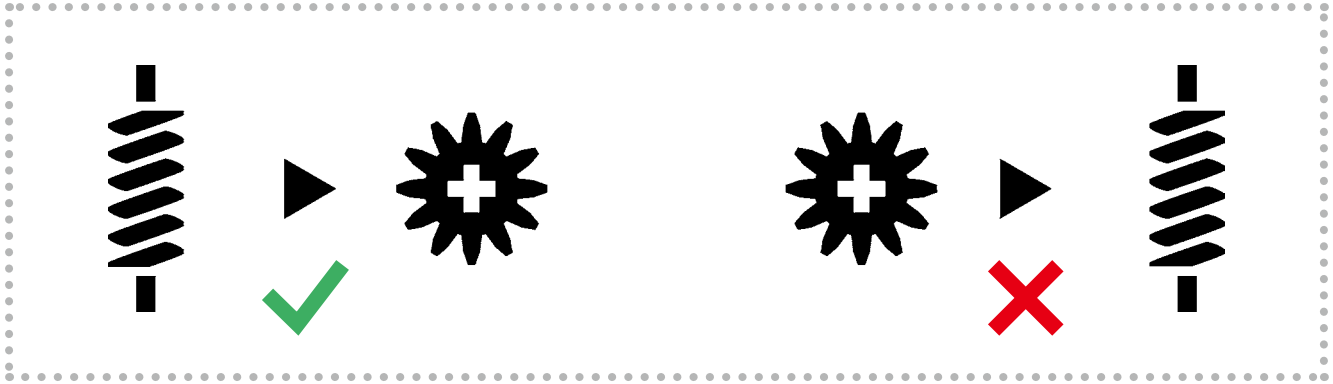

Using worm drives

#45



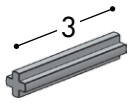
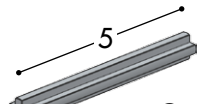
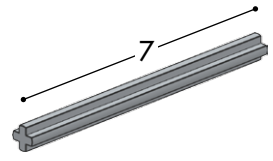

#46

-  x4
- 
- 
-  3
-  5
-  7
-  x2
-  x4
-  x2
-  x3

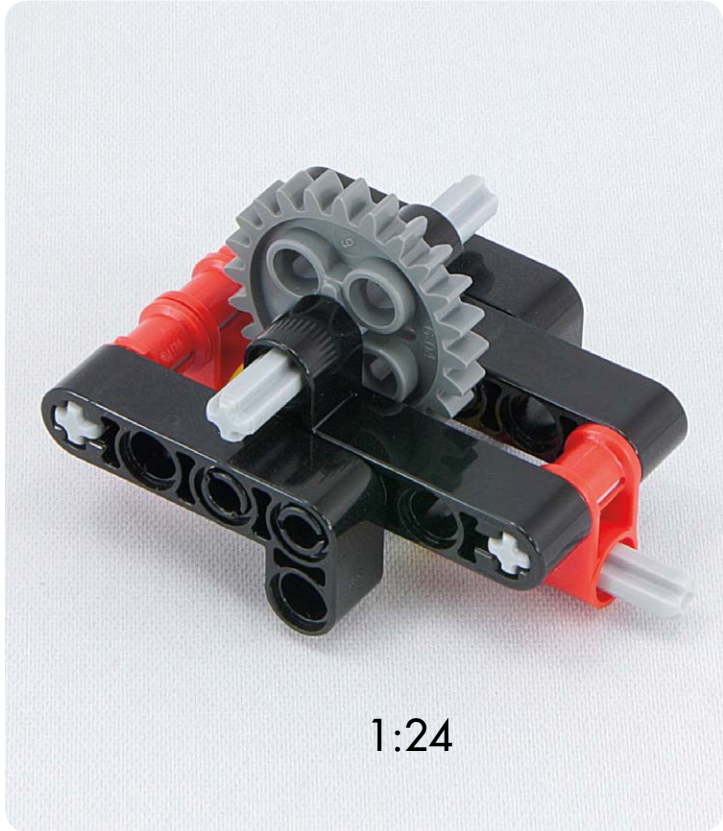

#47

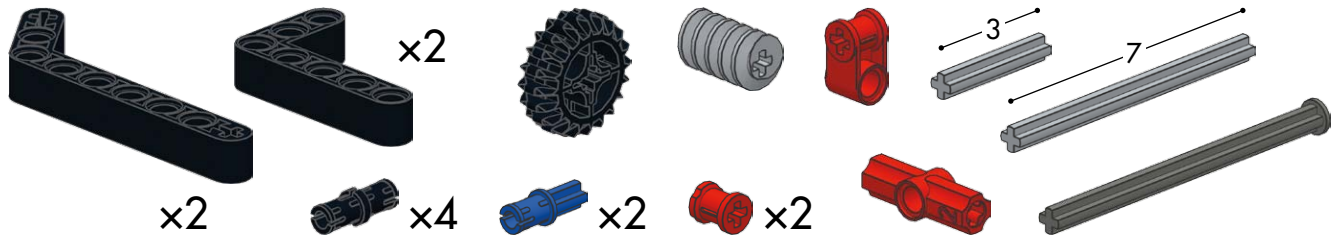

#48

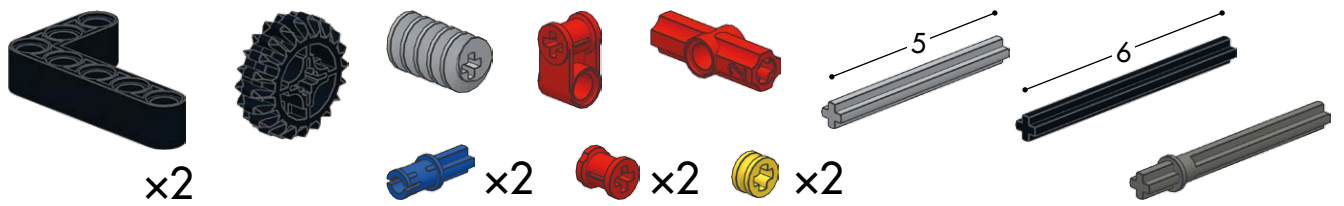

#49

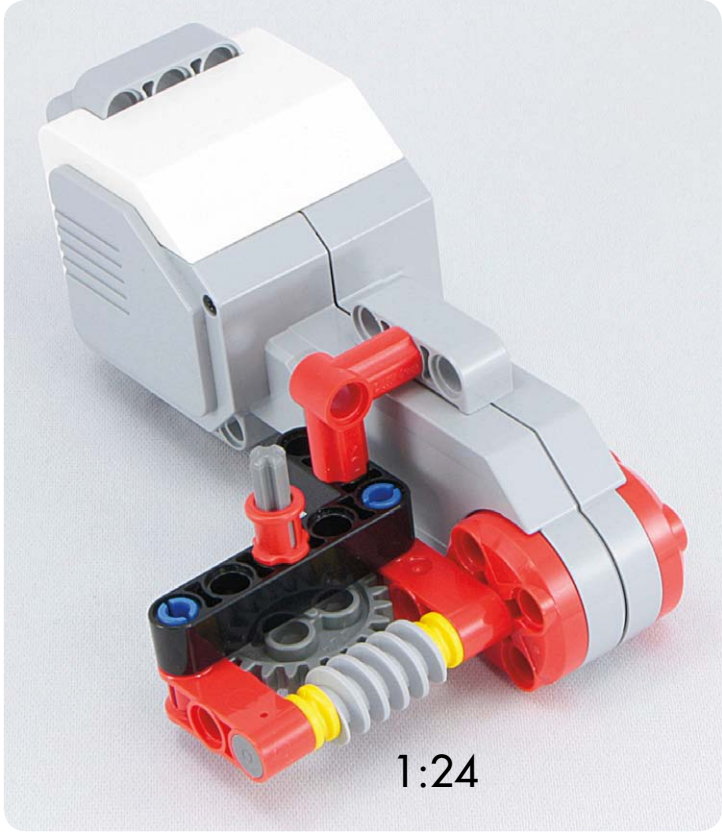
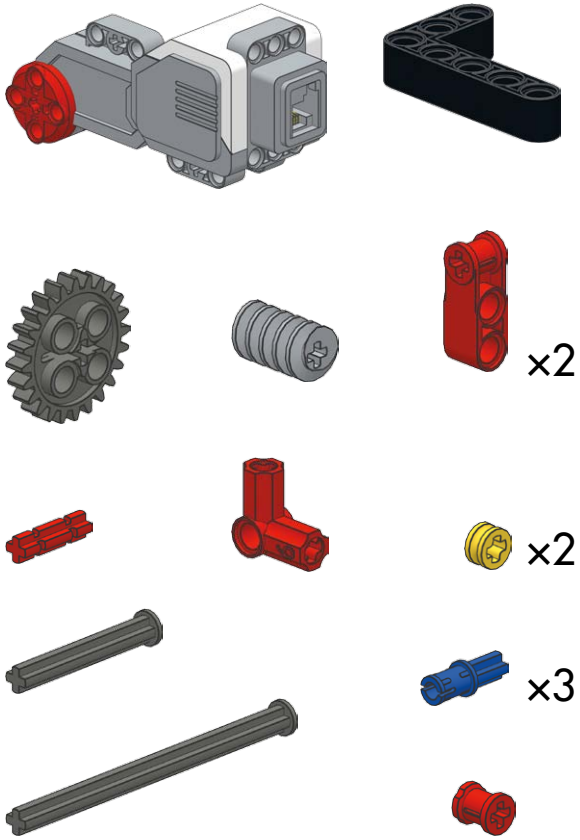

#50

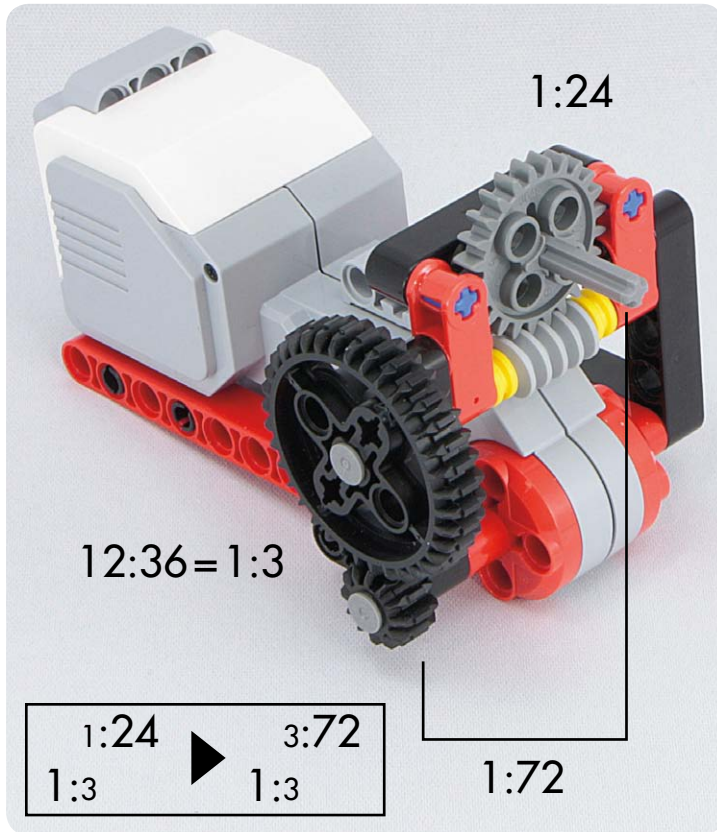

#51

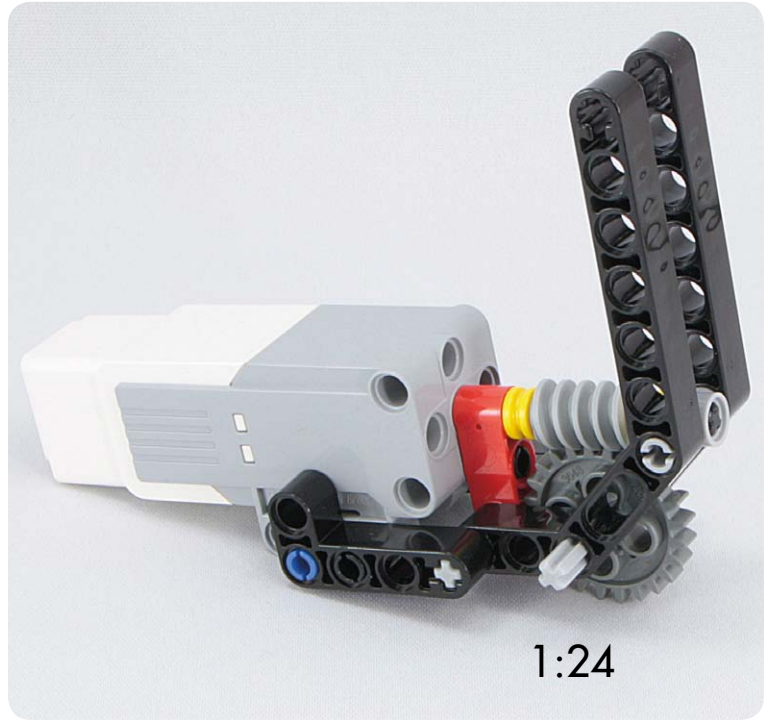
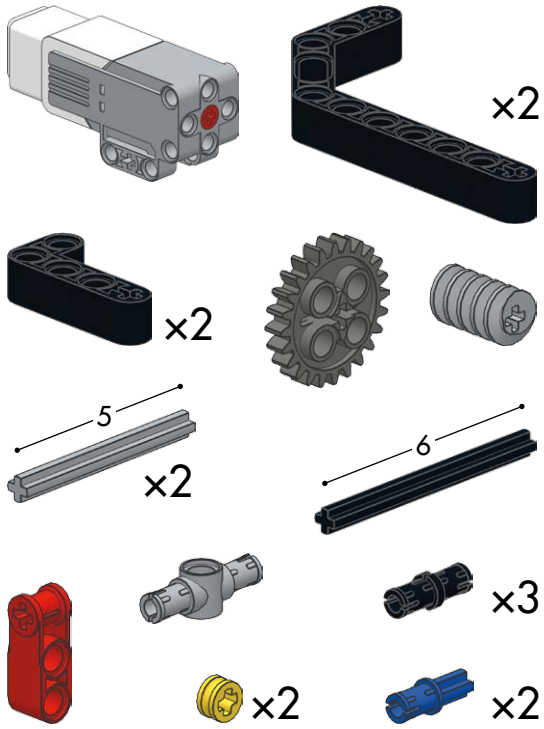

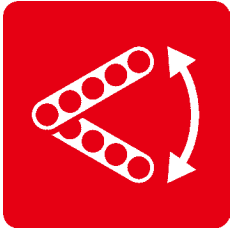

Swinging mechanisms

#52

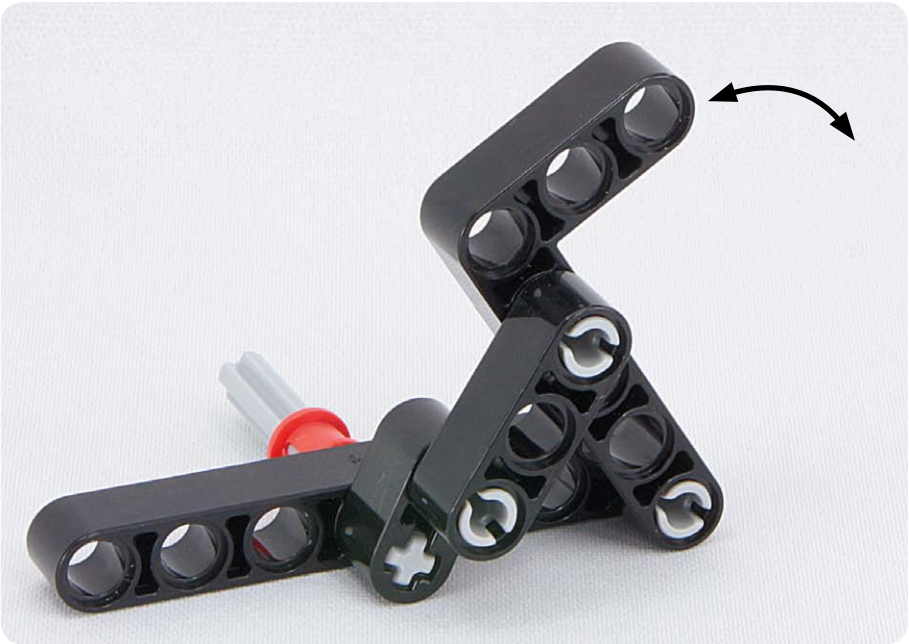
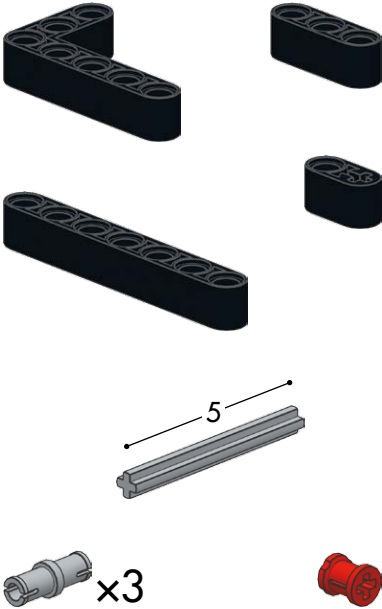

#53

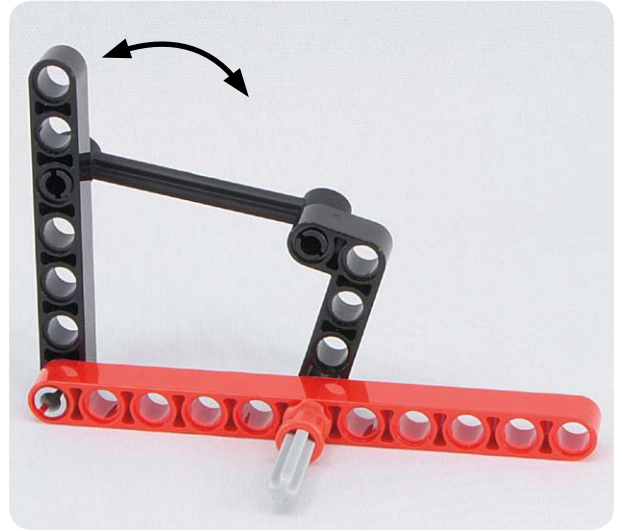
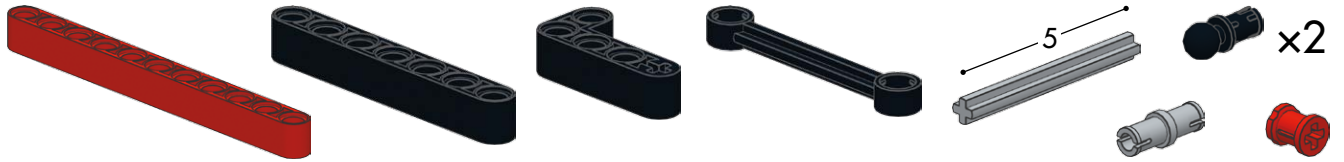

#54

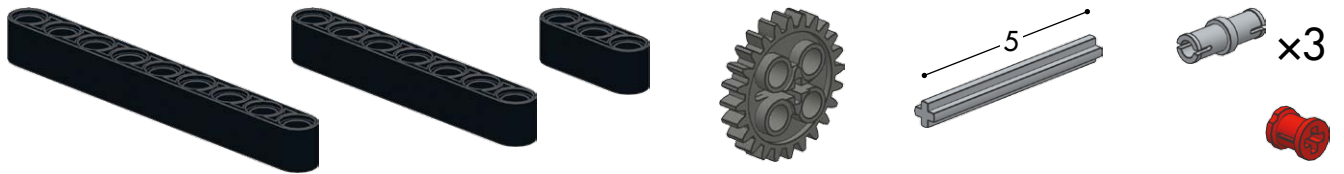

#55

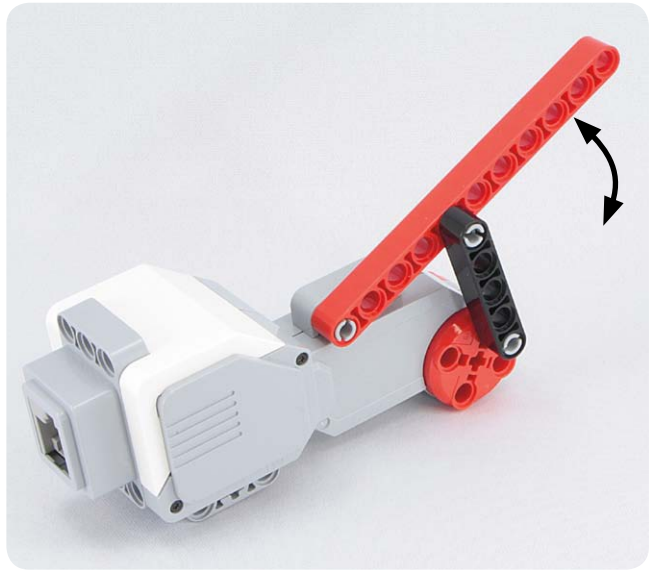
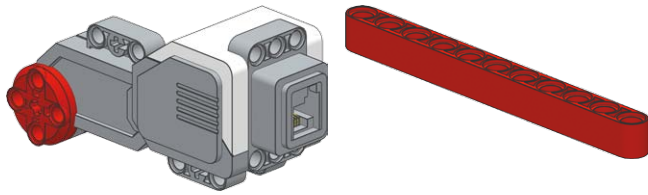

#56

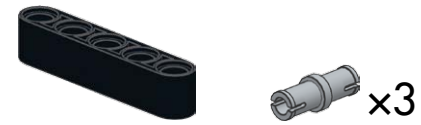
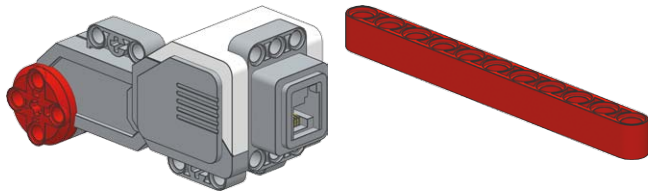

#57

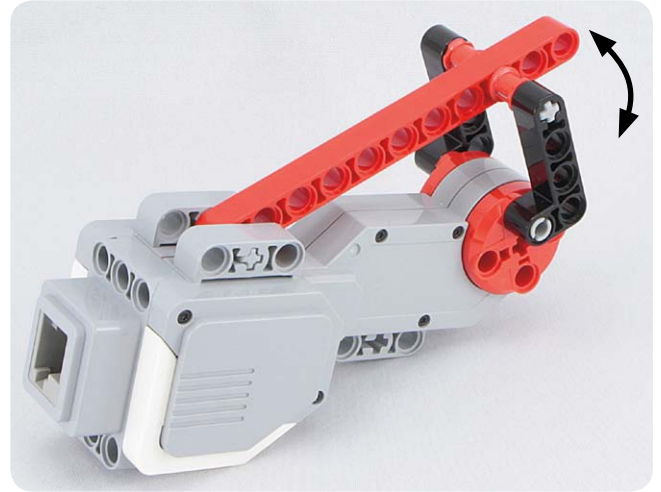
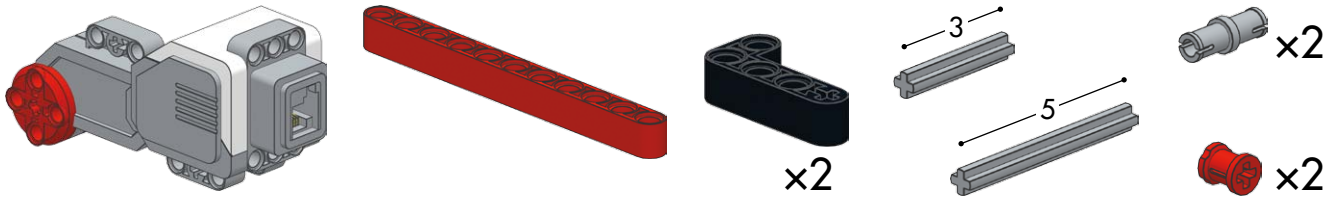

#58

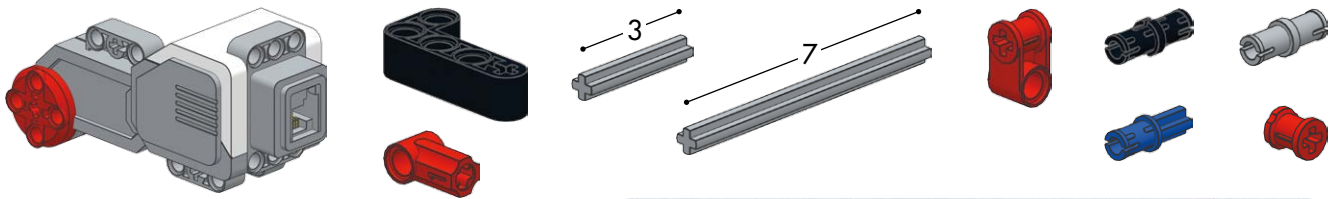

#59

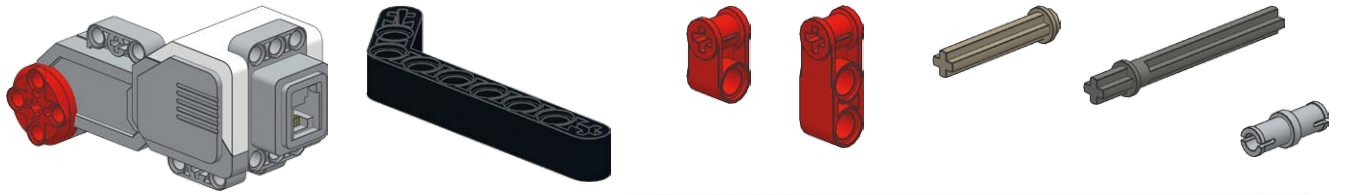

#60

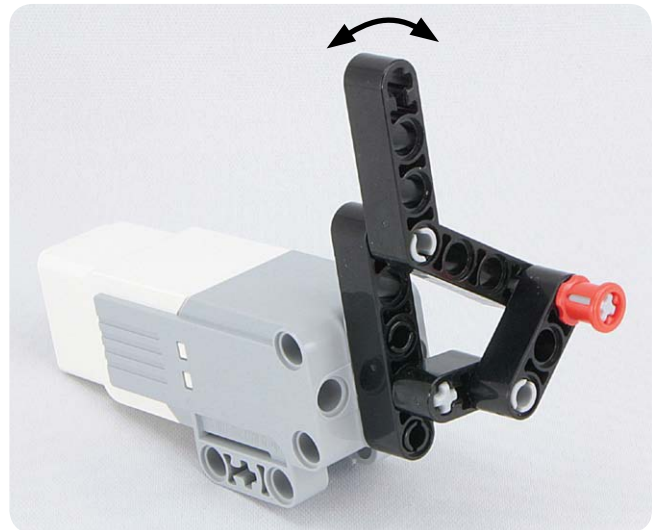

#61

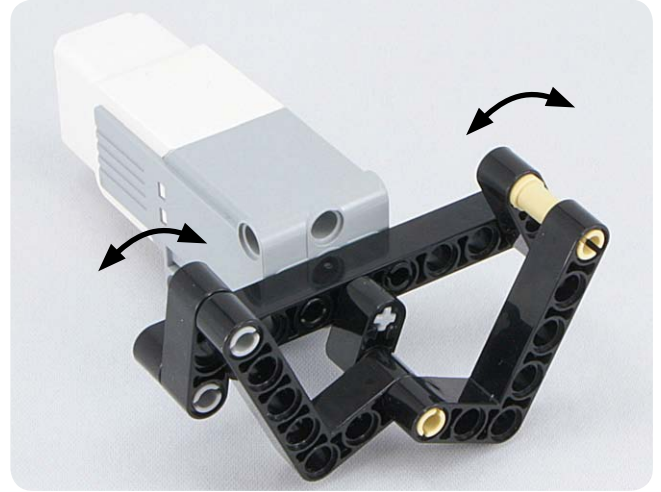
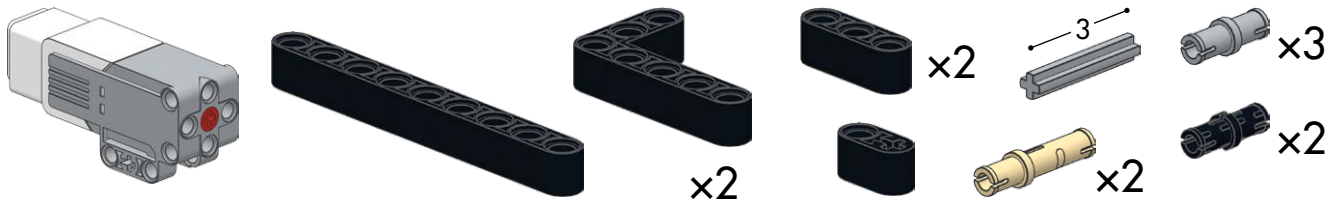

#62

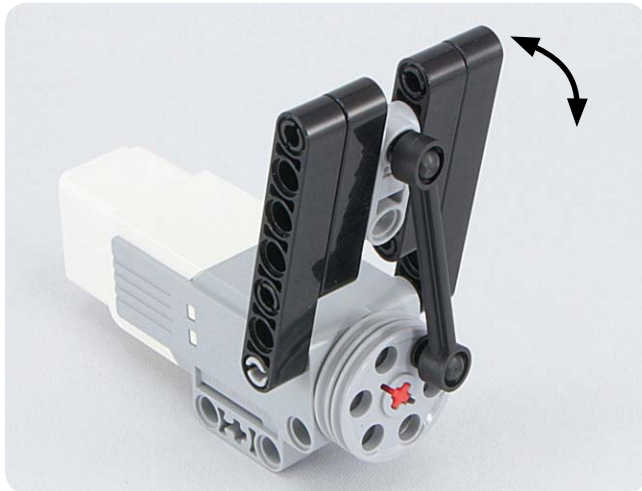
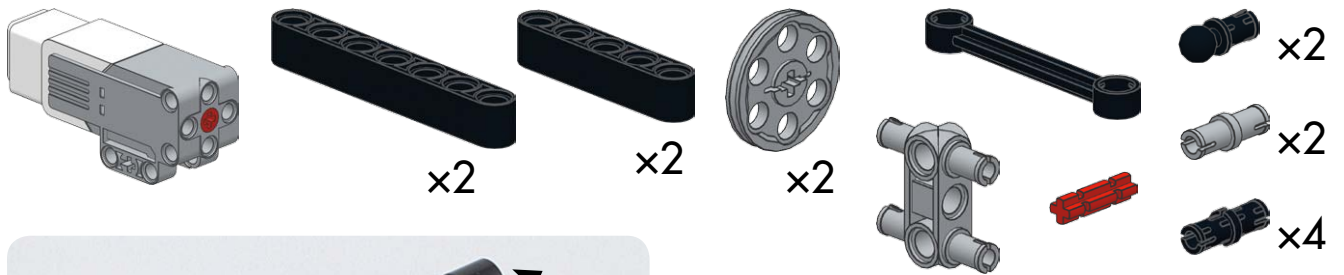

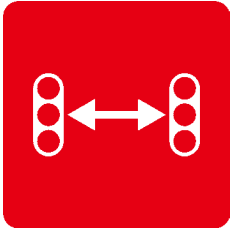

Reciprocating mechanisms

#63

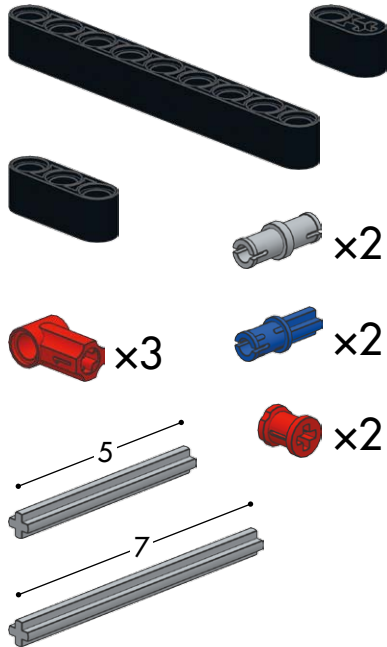

#64

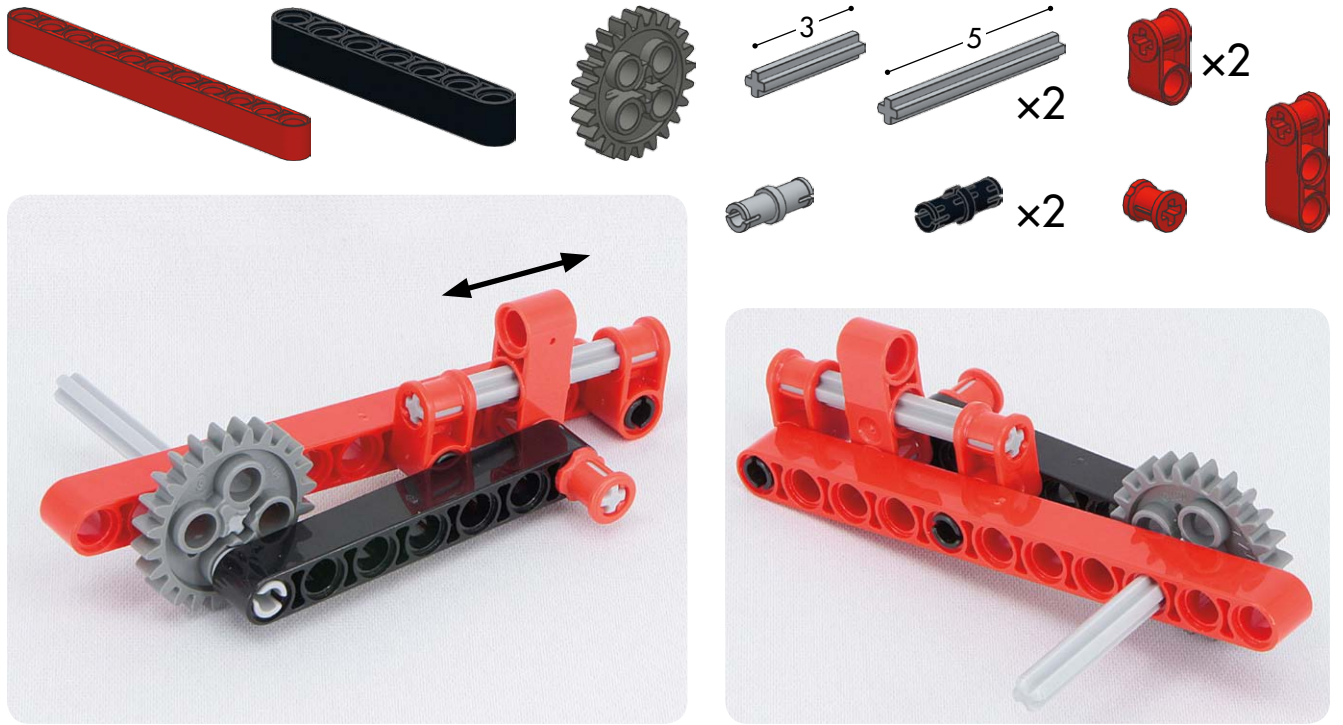

#65



#66

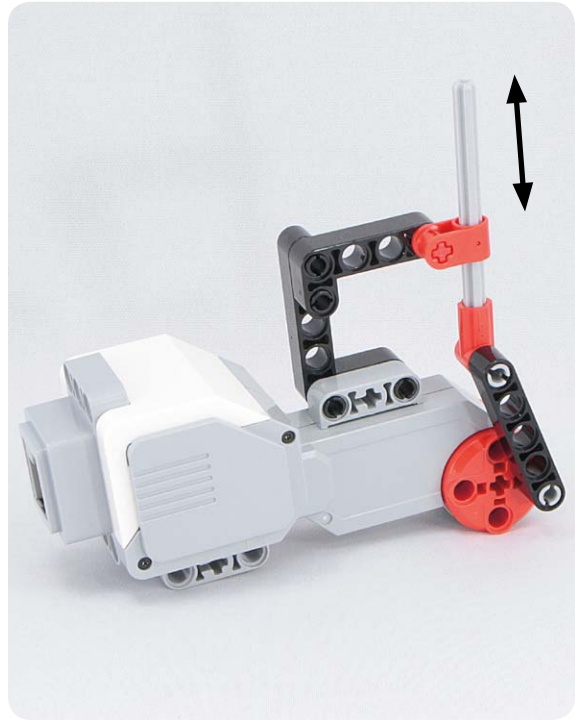
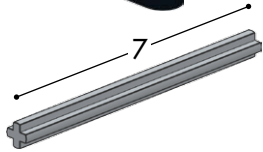
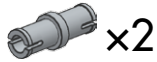
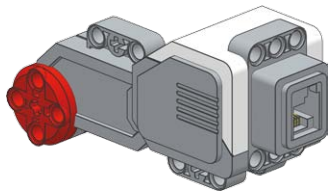

#67

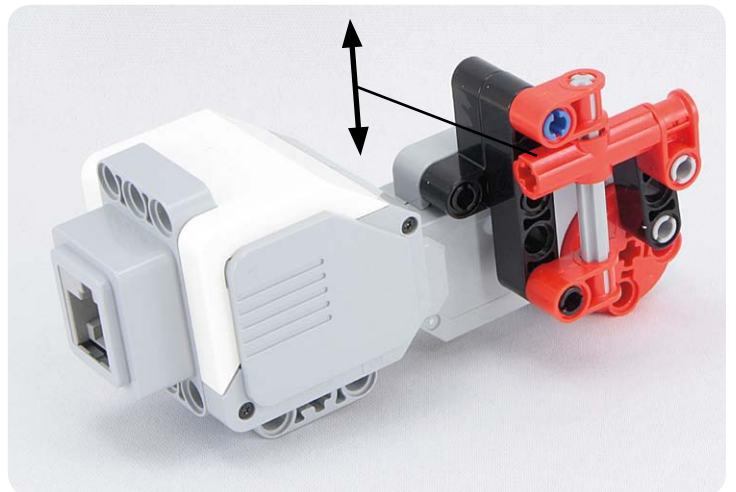
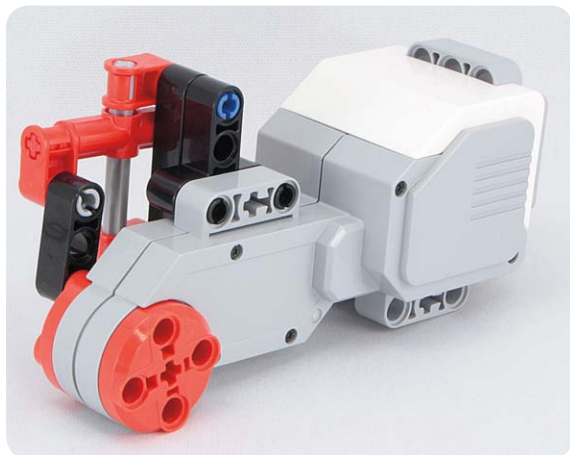
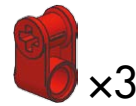
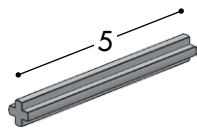
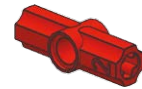
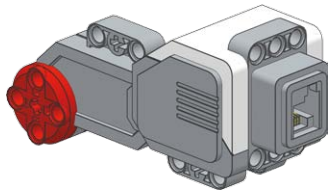

#68

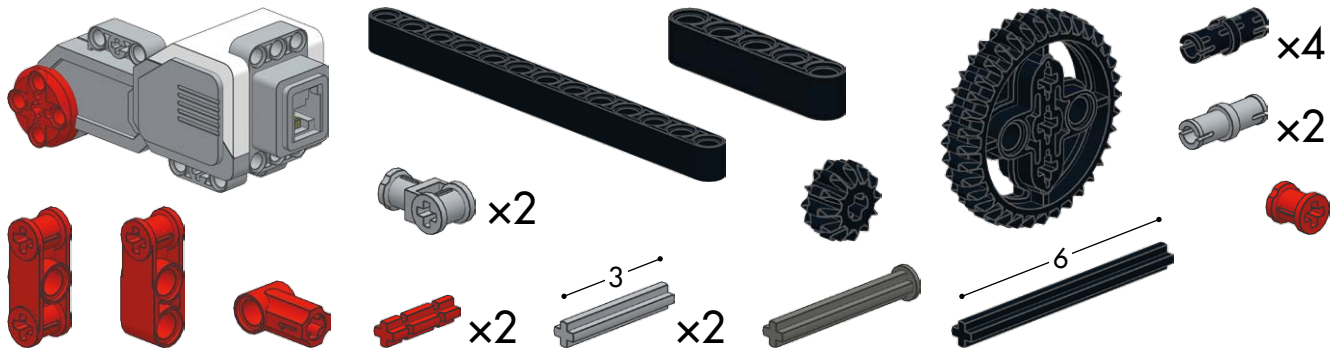

#69

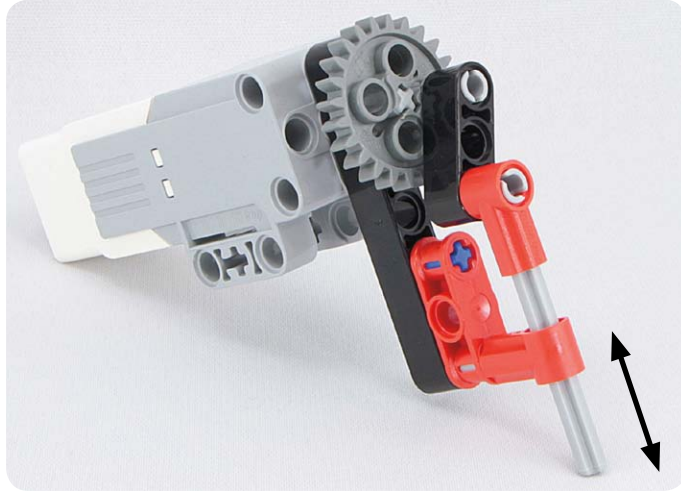
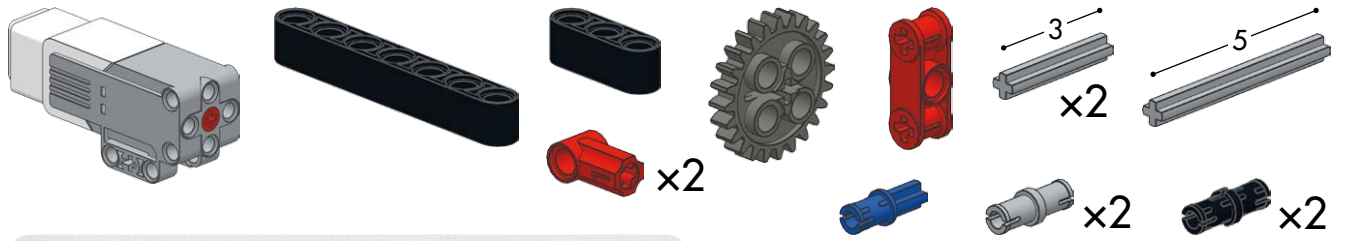

#70

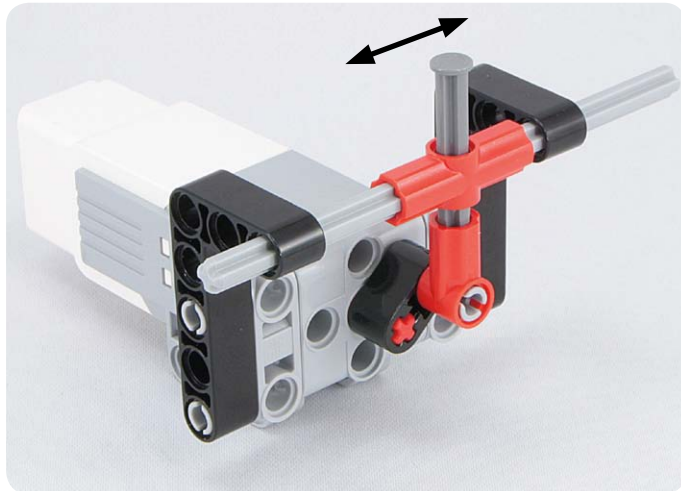
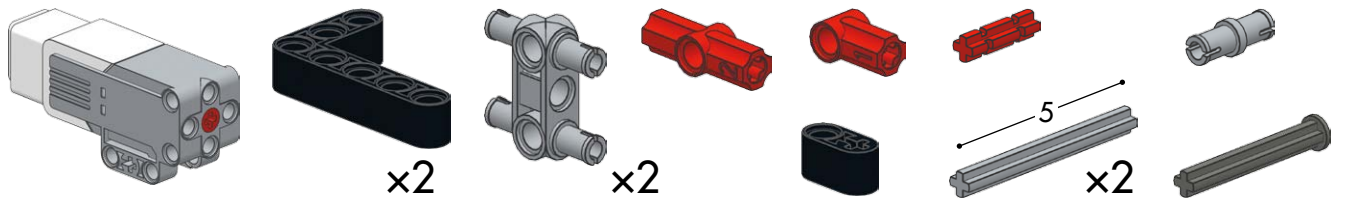

#71

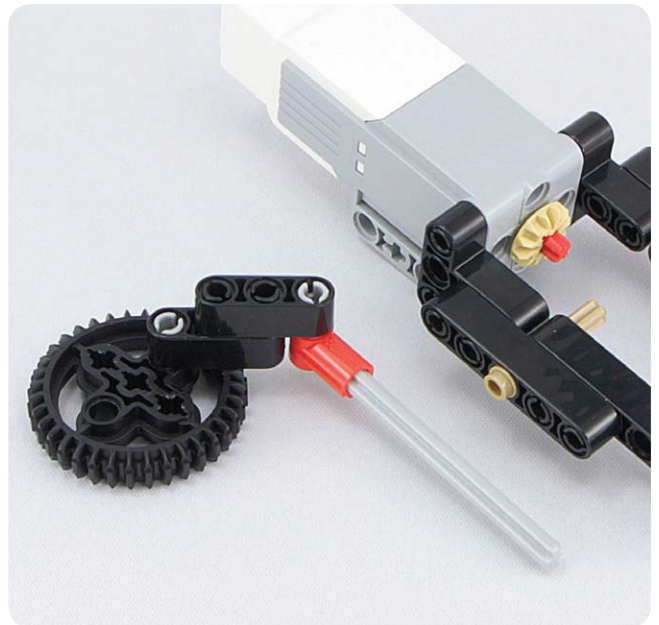
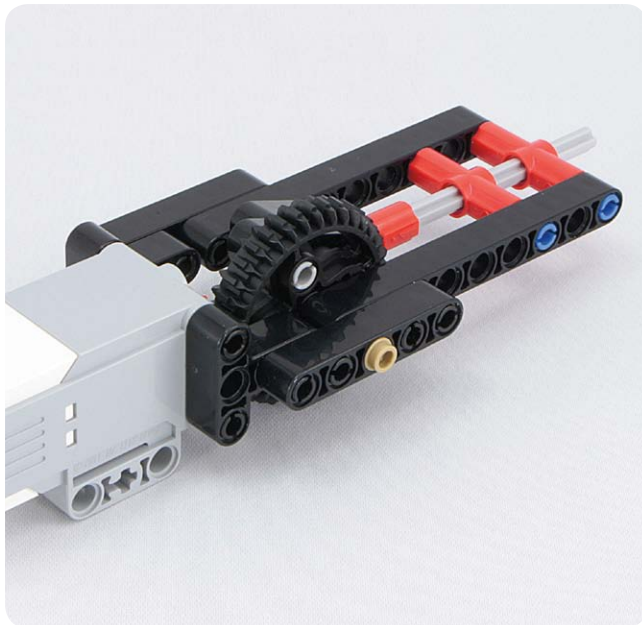
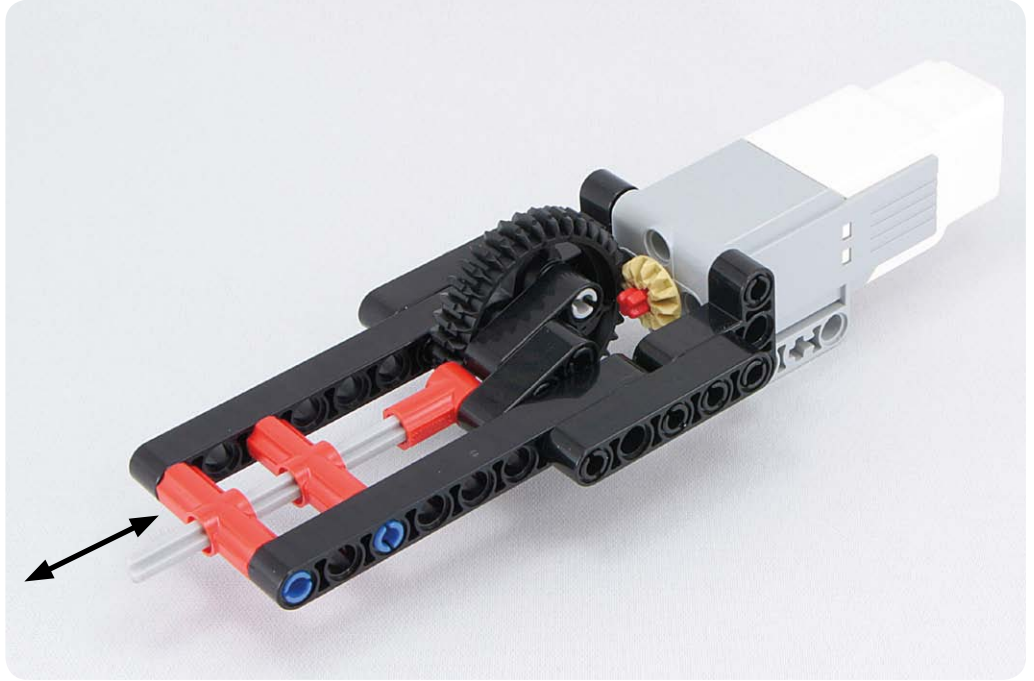
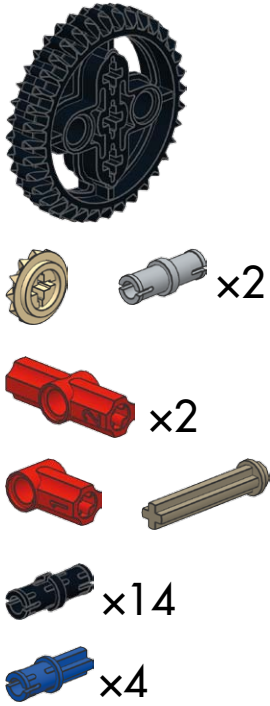
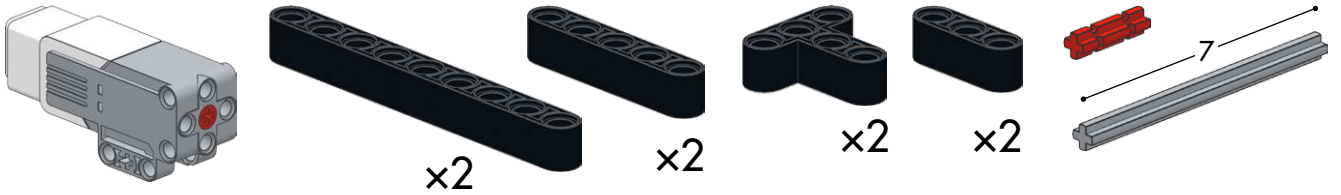

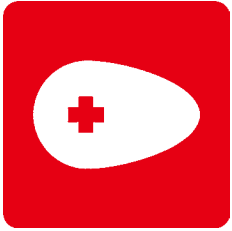

Cam mechanisms

#72

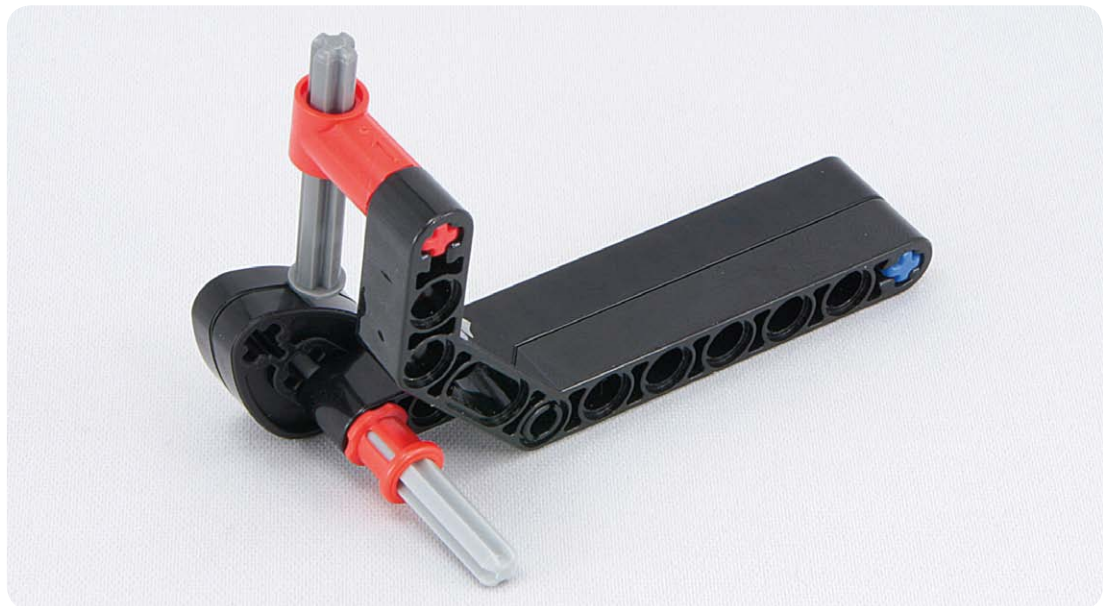
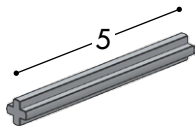
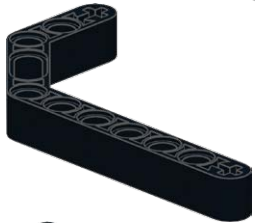

#73



#74

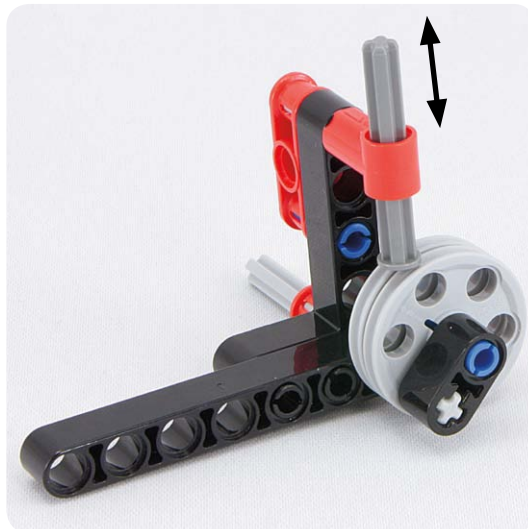
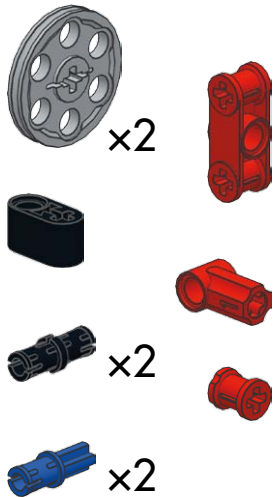
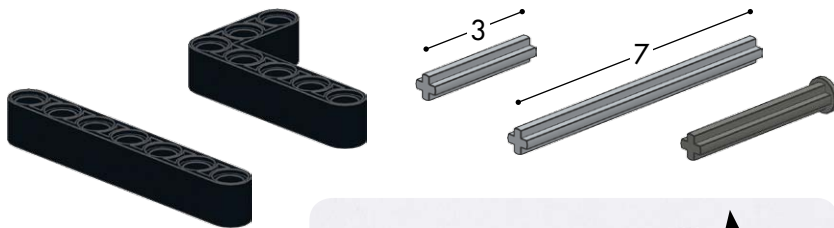

#75

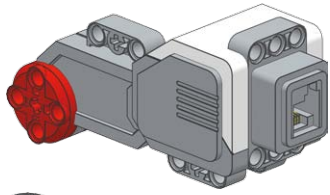

x2

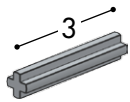
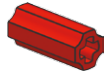

3

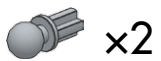

x2

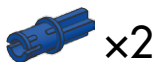

x2



x2

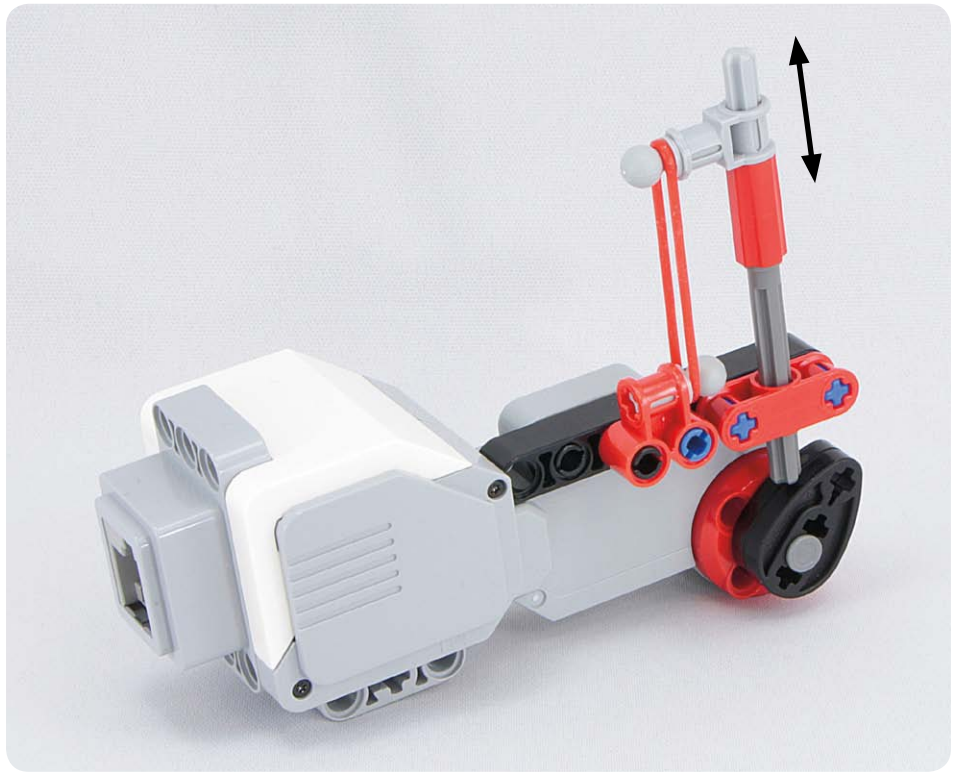

#76

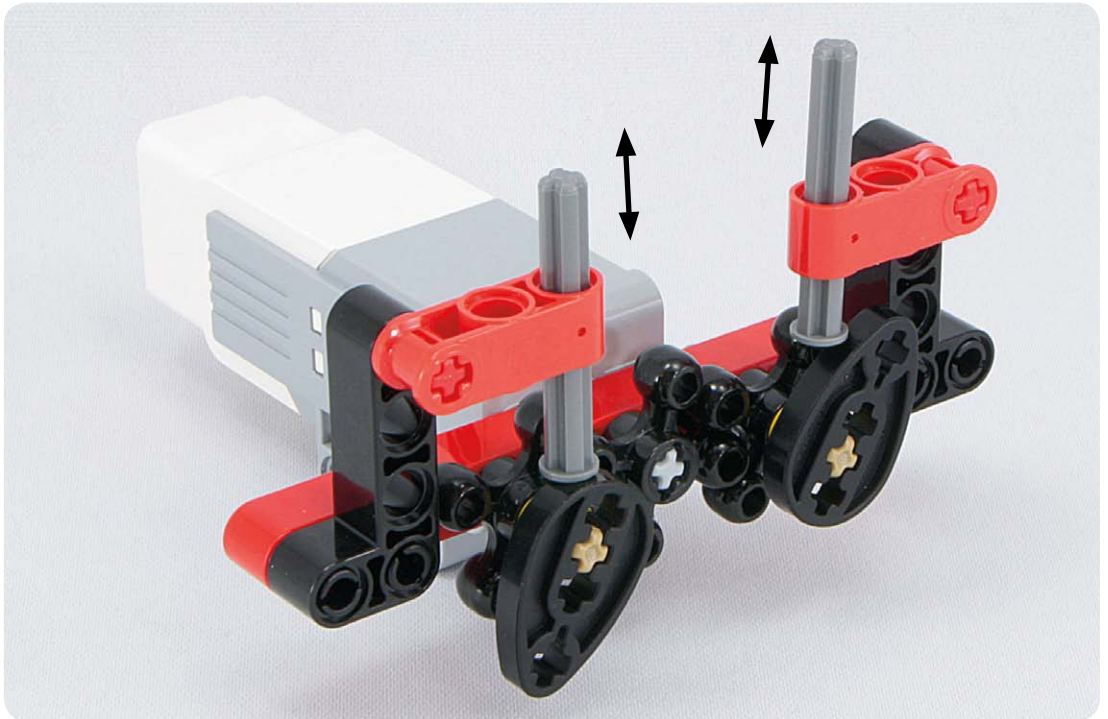
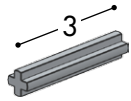
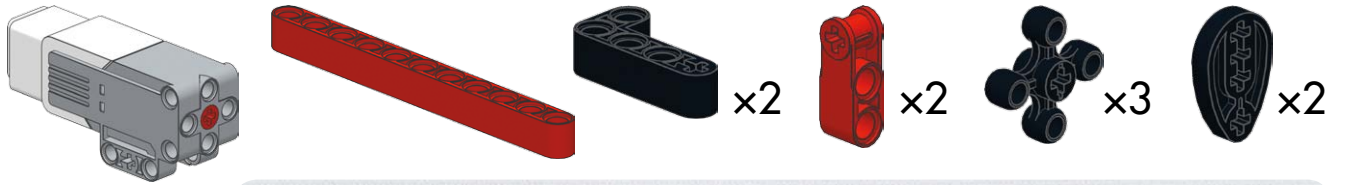

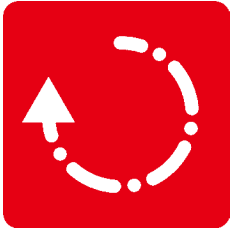

Intermittent motion

#77

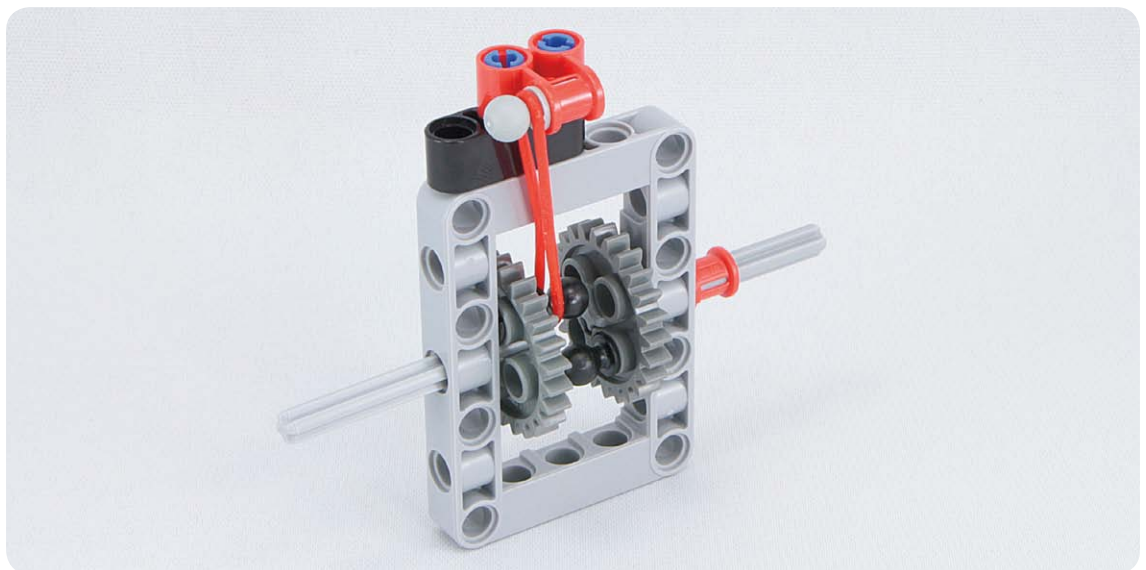
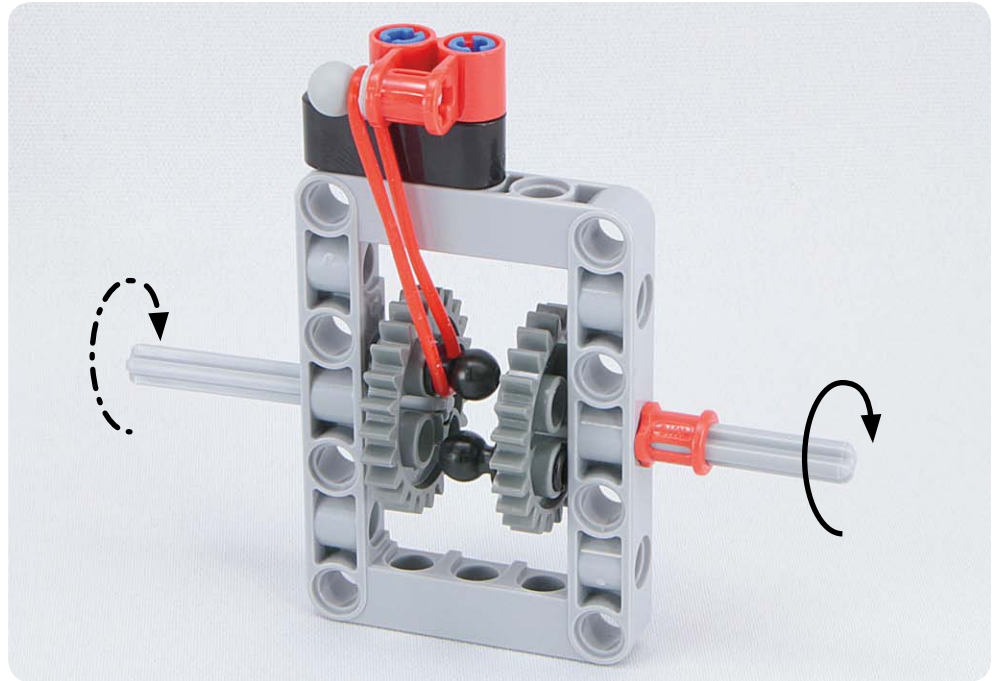
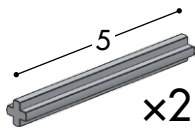
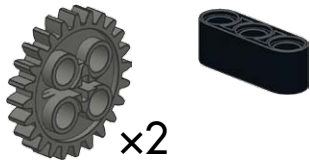
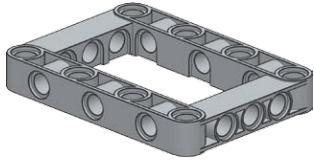

#78

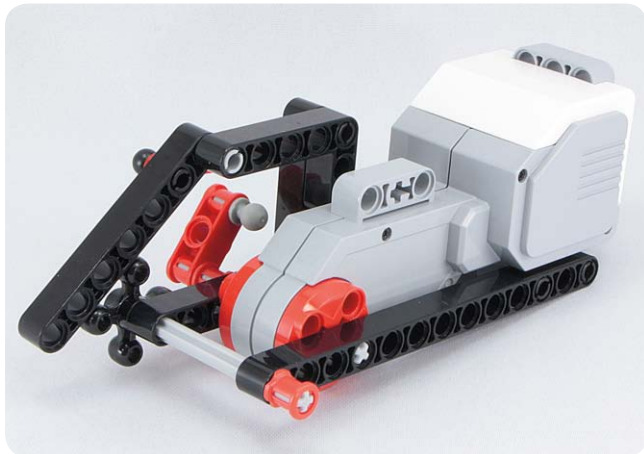
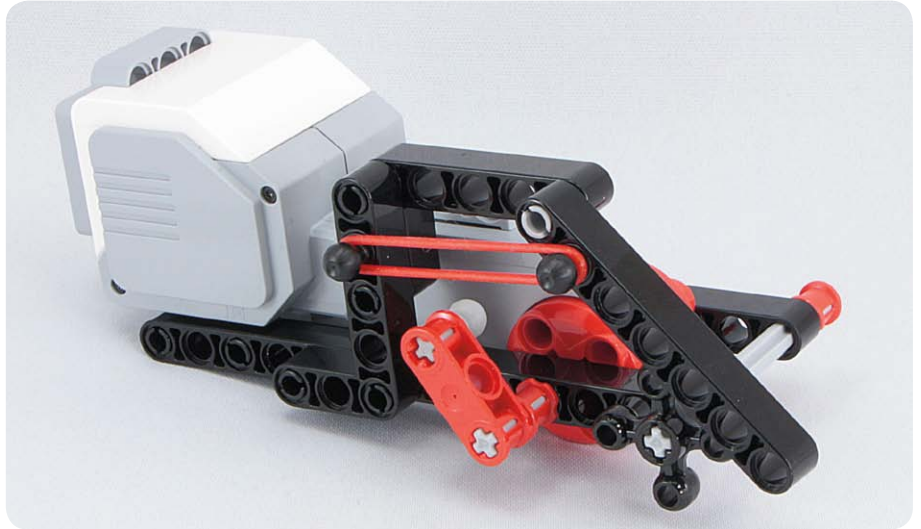
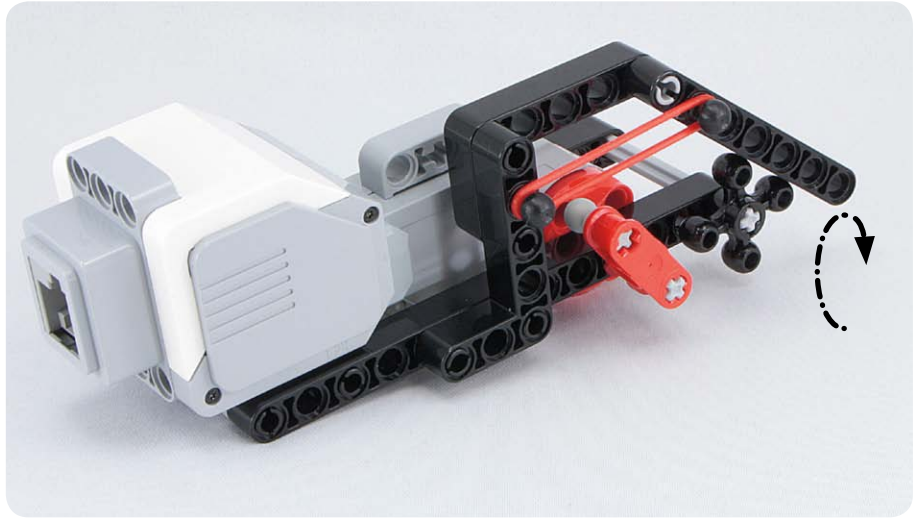
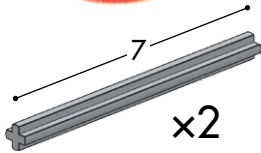
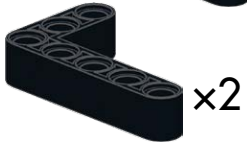
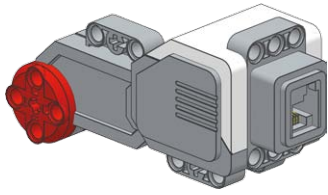

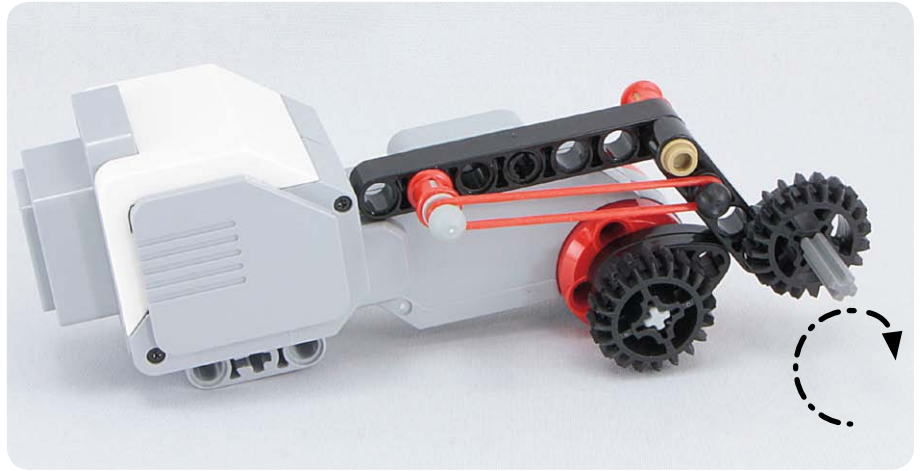

#80

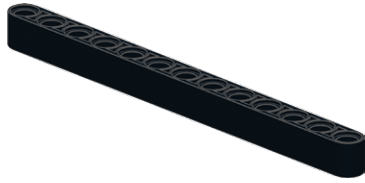
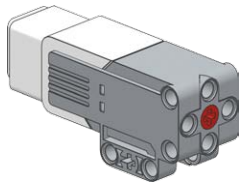

x2



x2

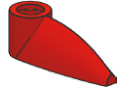

x2



x3



x2



x2



x2

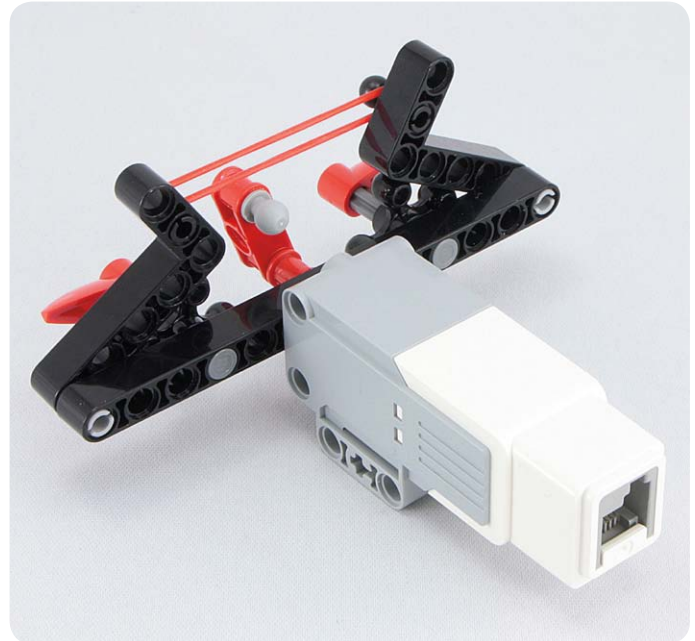
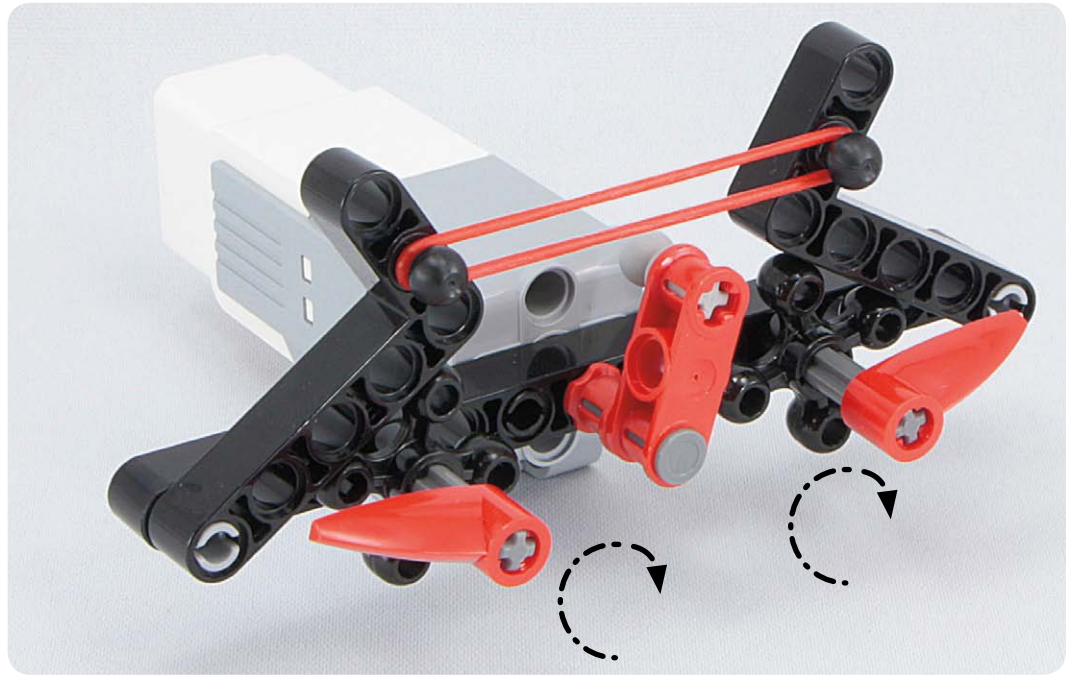

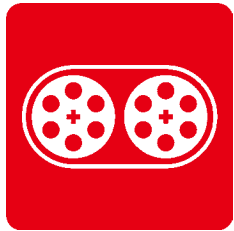

Transmitting rotation with rubber bands

#81

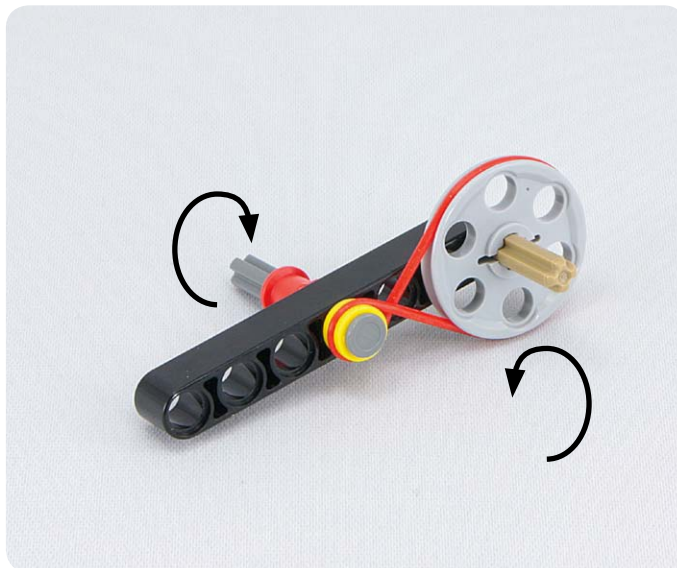
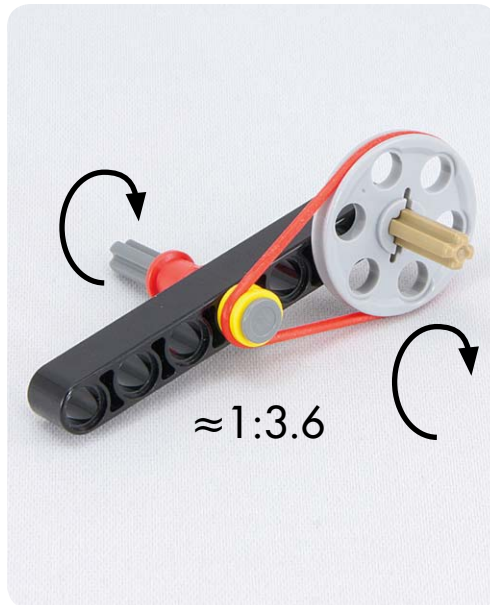
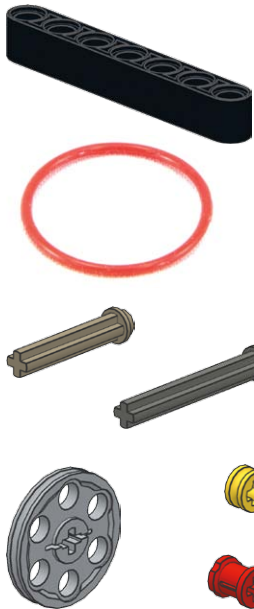

#82

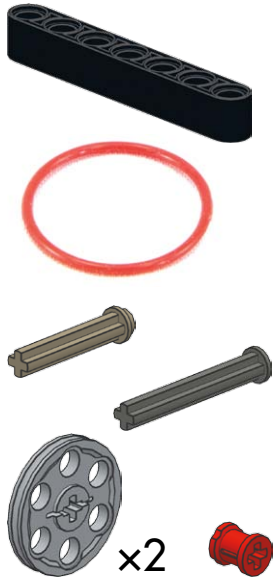

#83



#84

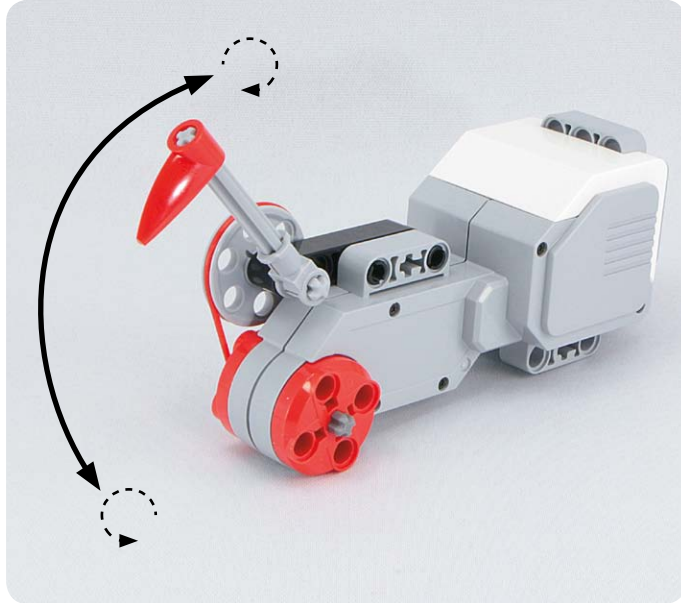
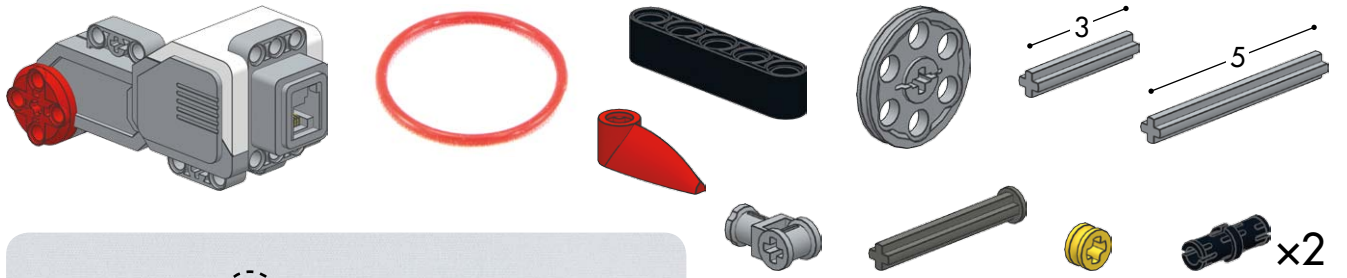

#85

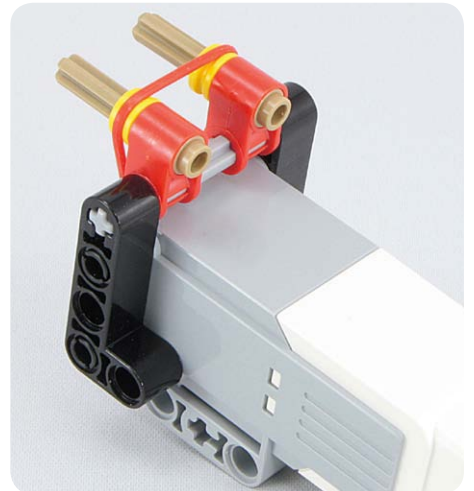
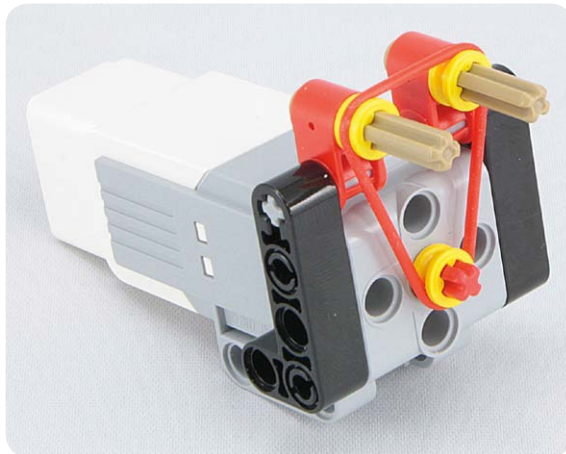
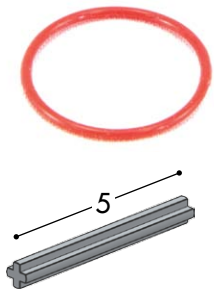
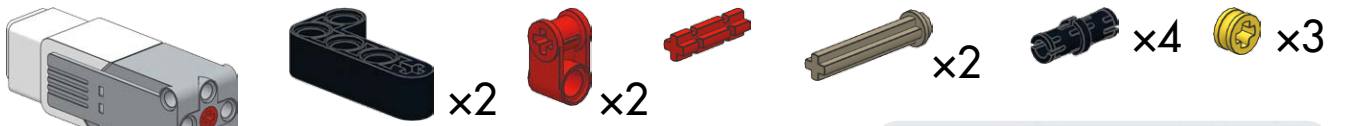

#86

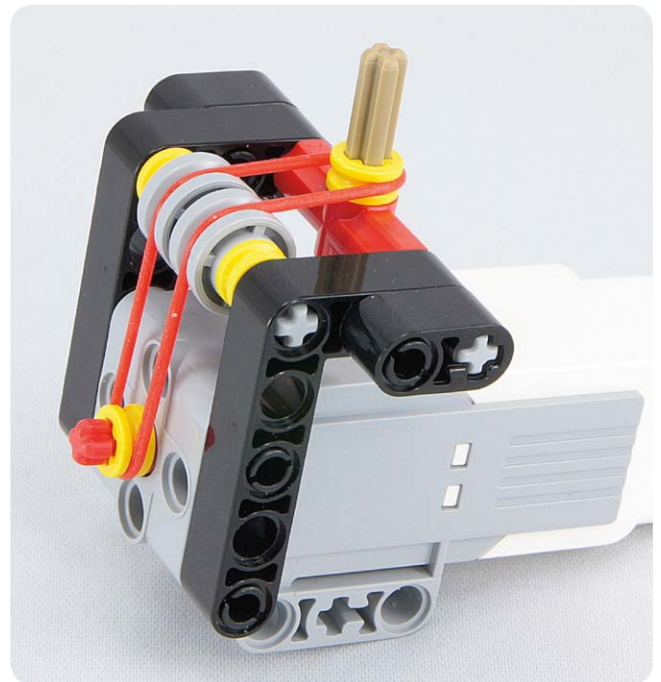
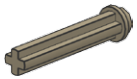
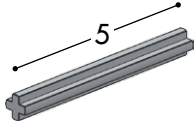
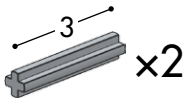
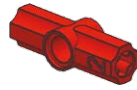
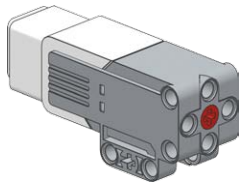

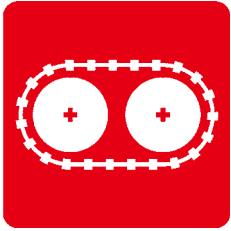

Transmitting rotation with caterpillar treads

#87

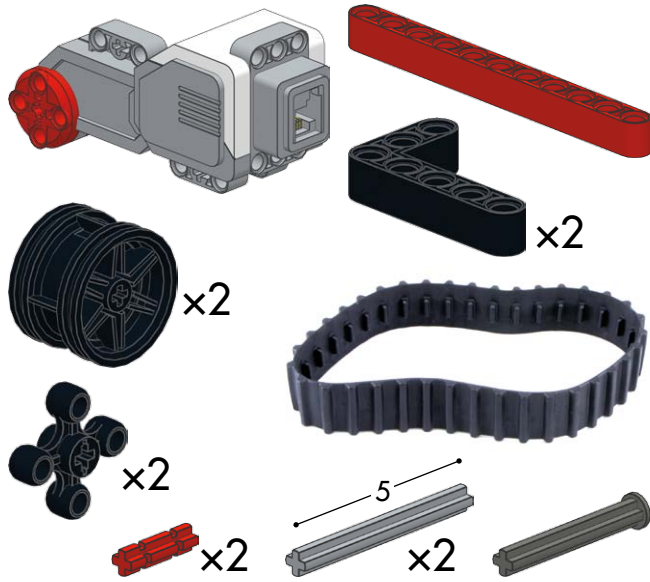

#88

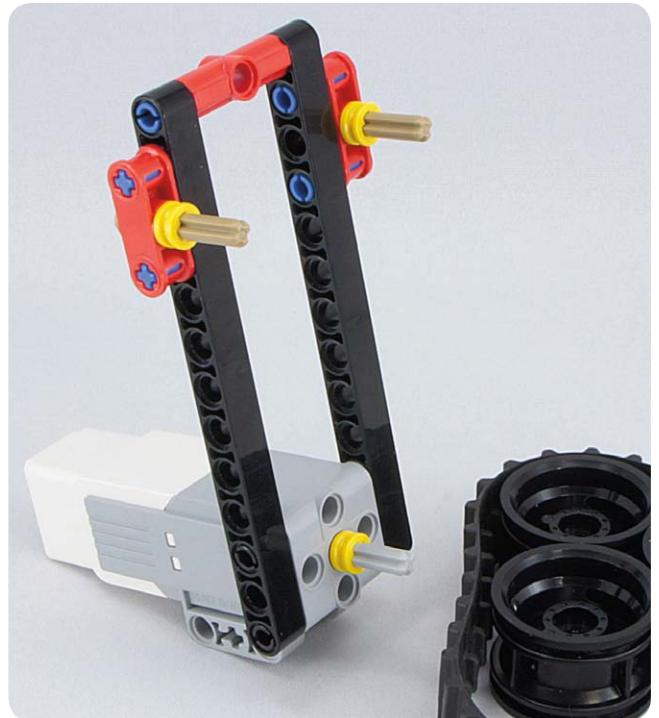
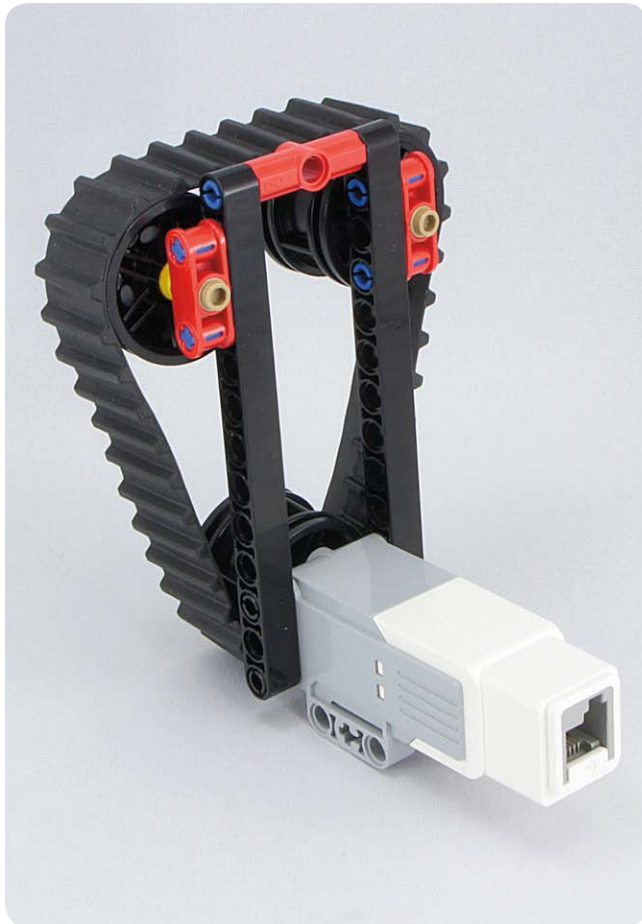
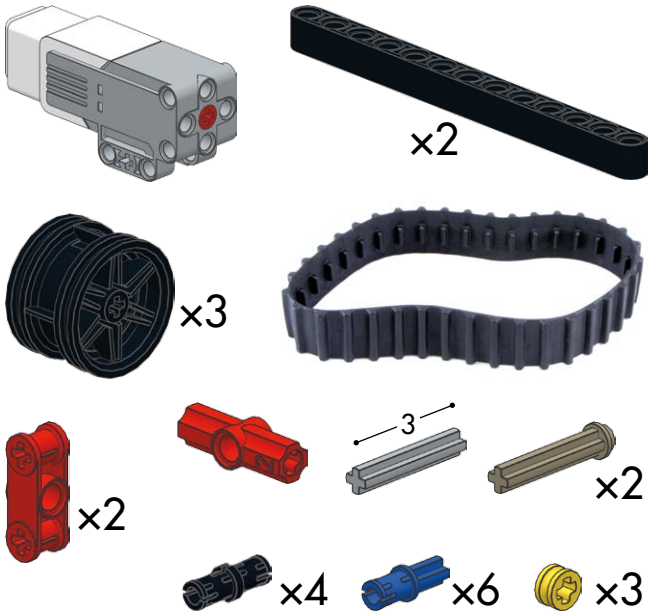

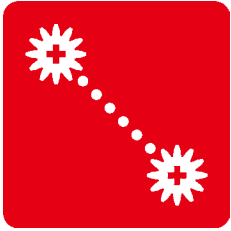

Transmitting rotation over a long distance

#89

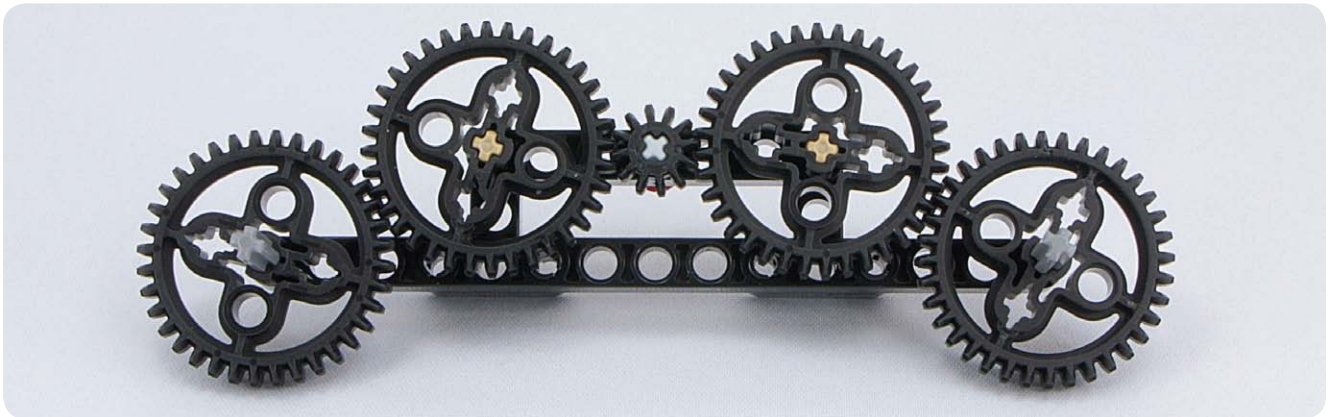

#90

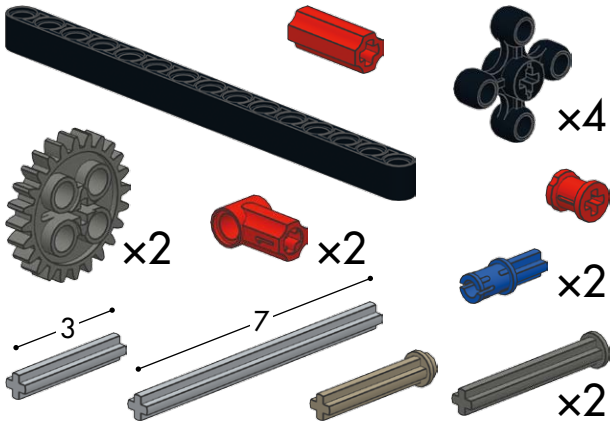
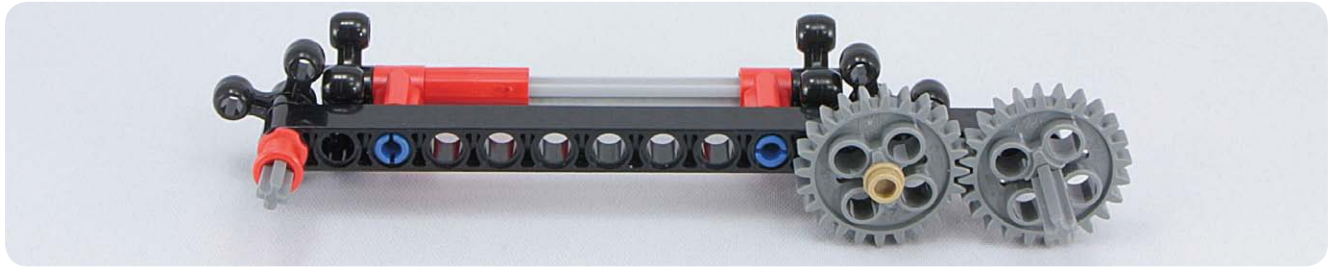

#91





Off-center axes of rotation

#92

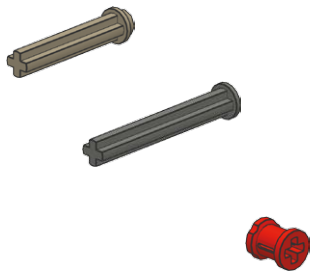
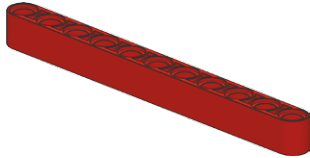

#93

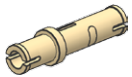
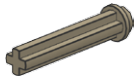
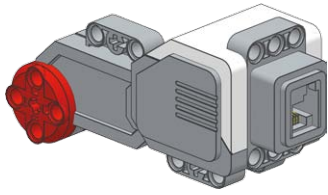

#94

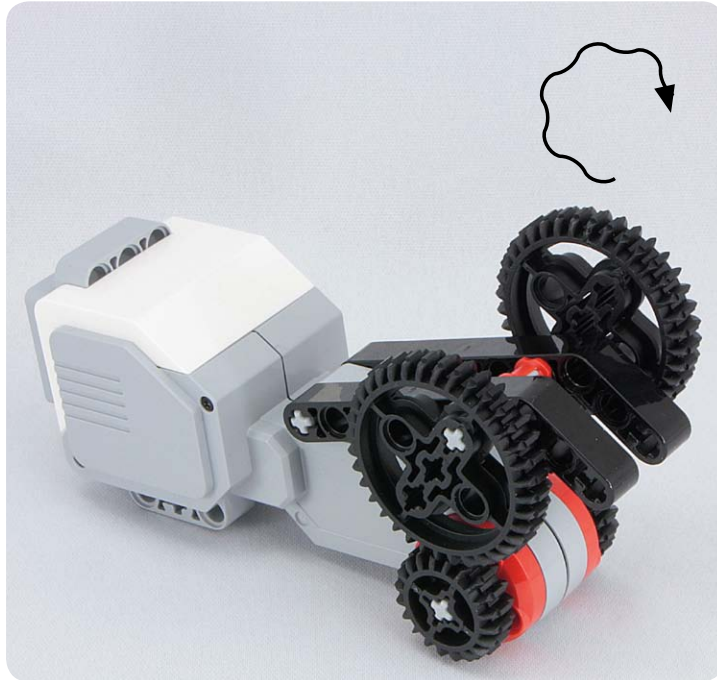

#95

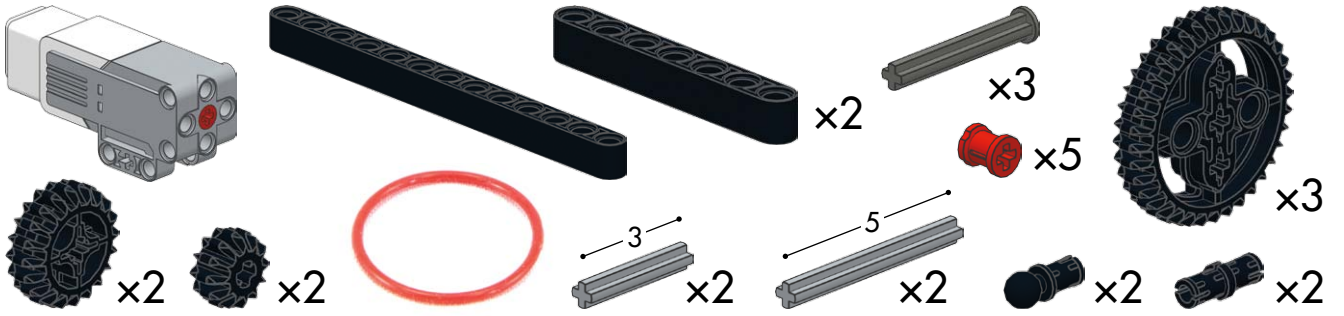

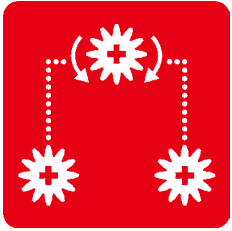

Changeover mechanisms using rotational direction

#96

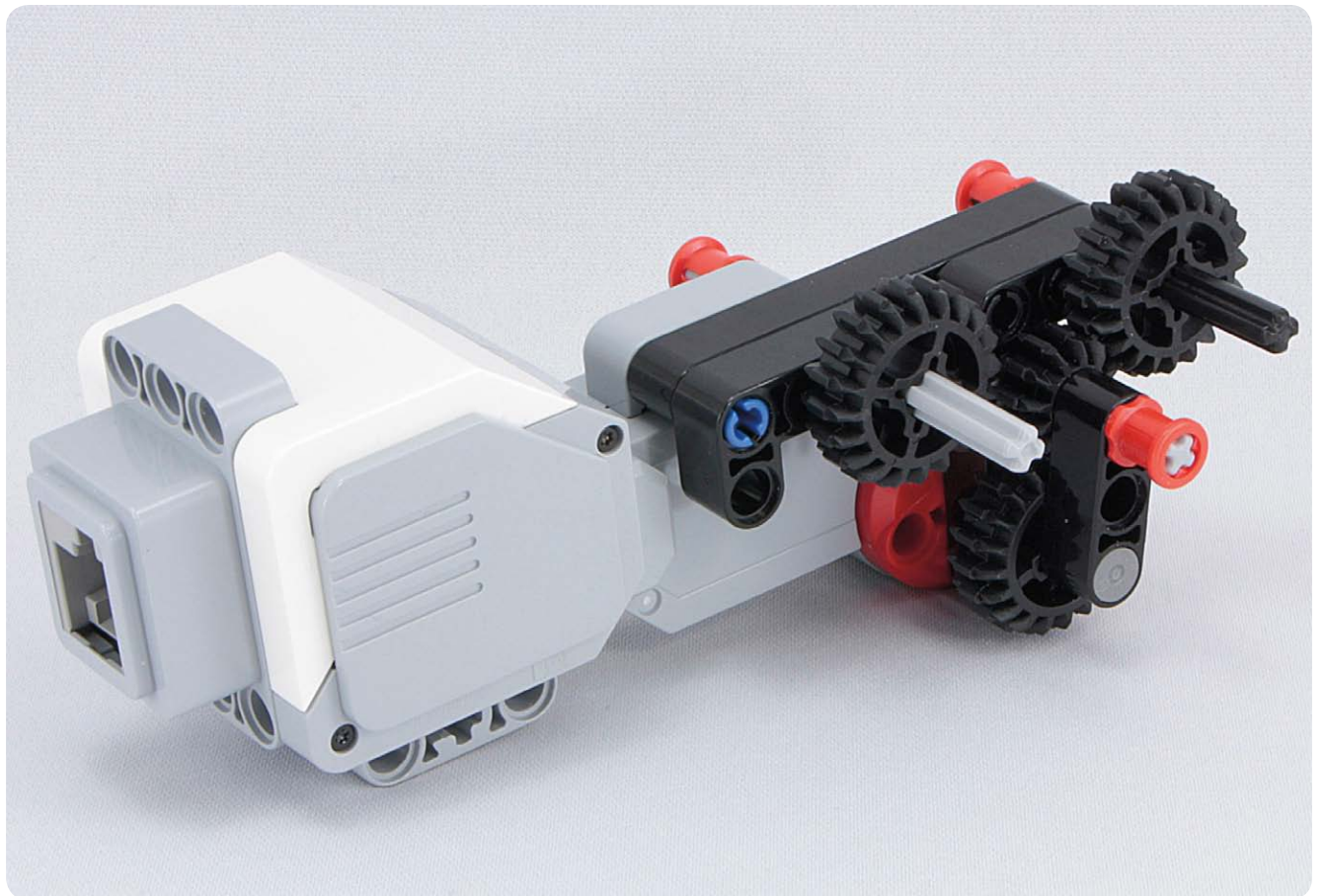
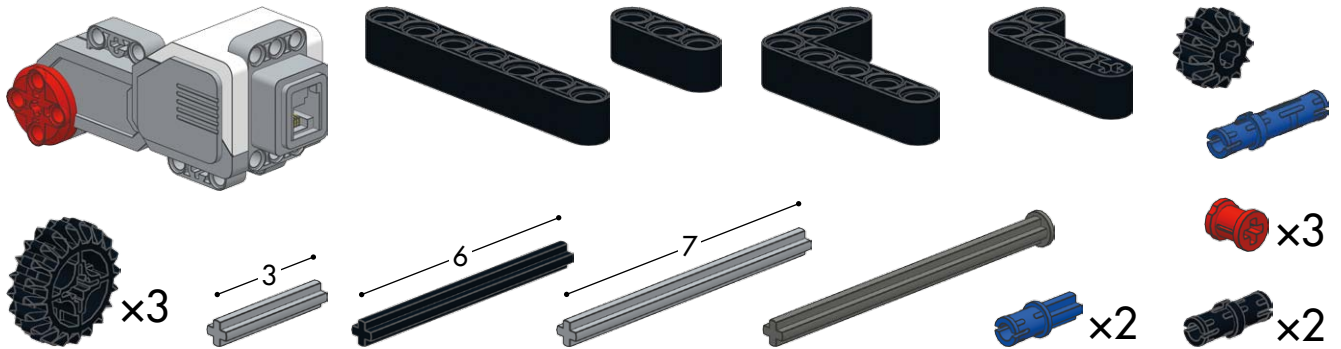



#97

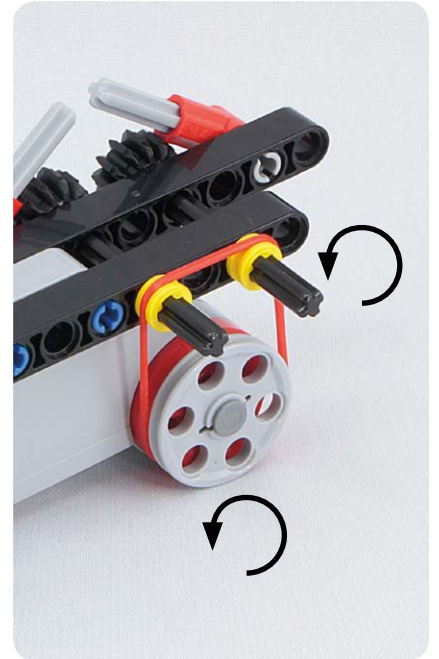
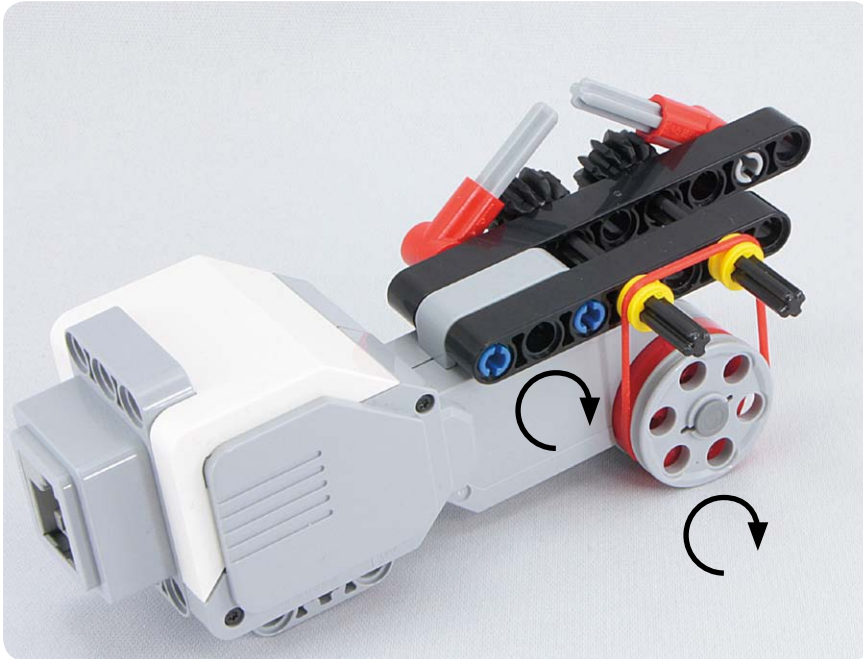
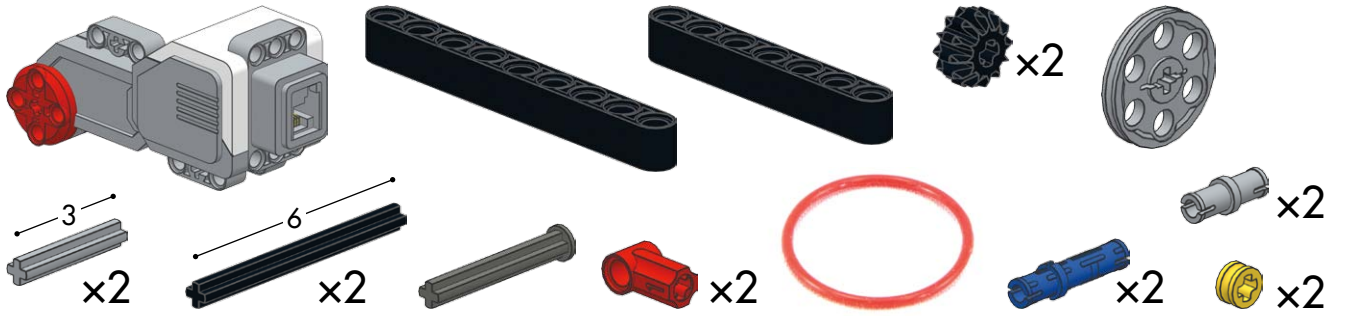

#98

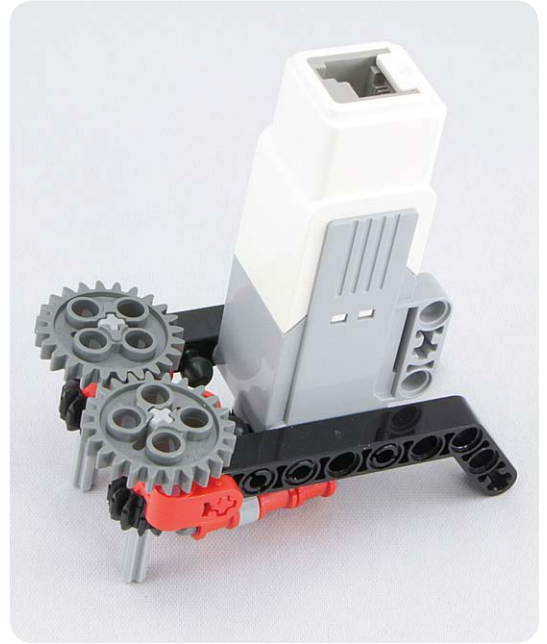
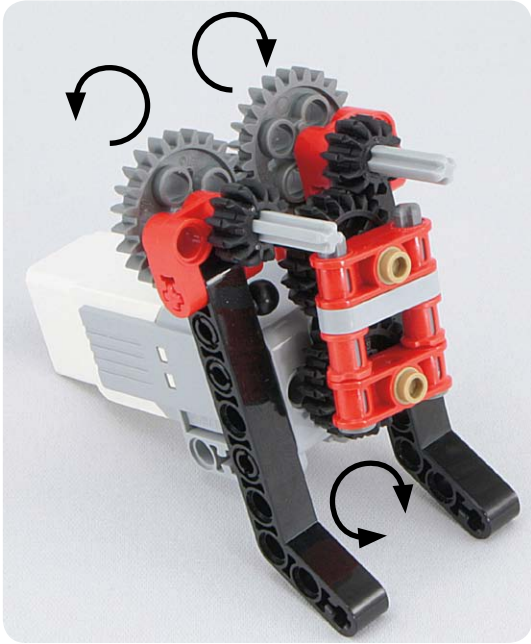
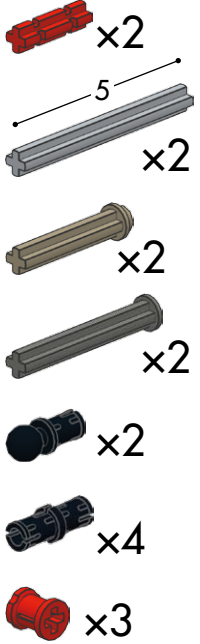
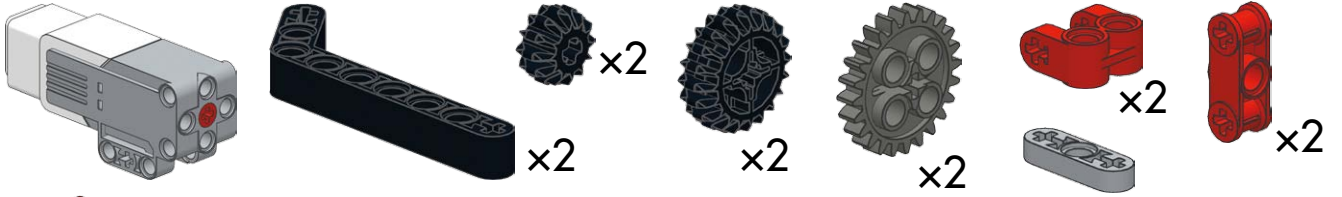

#99

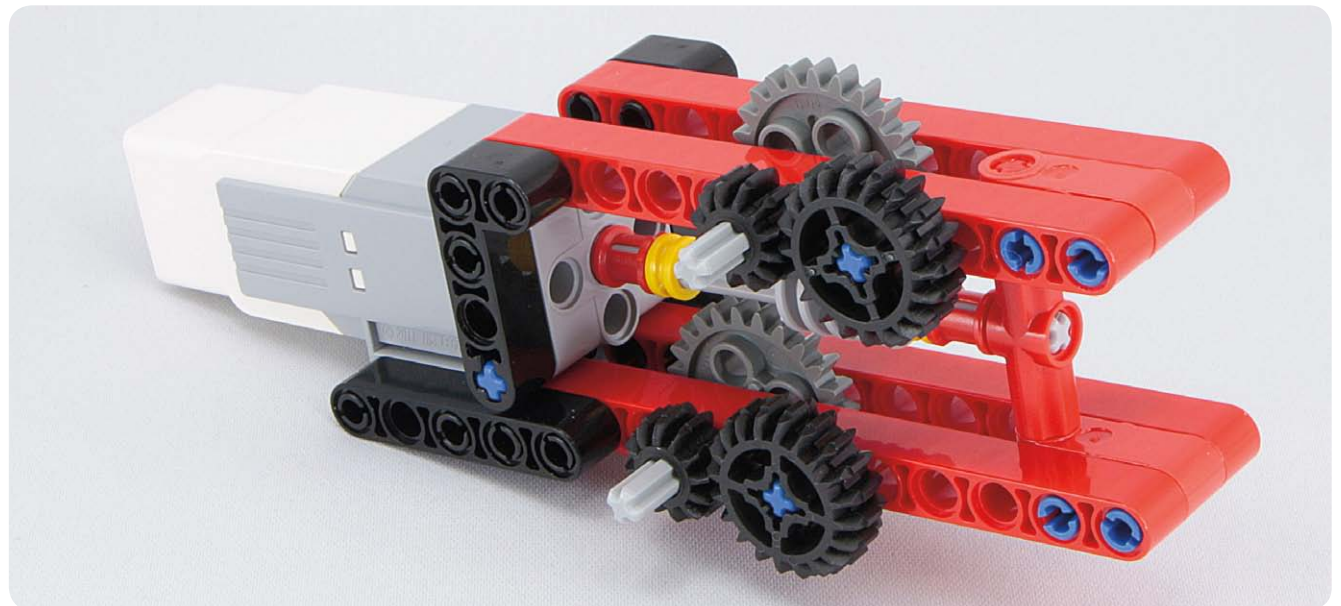
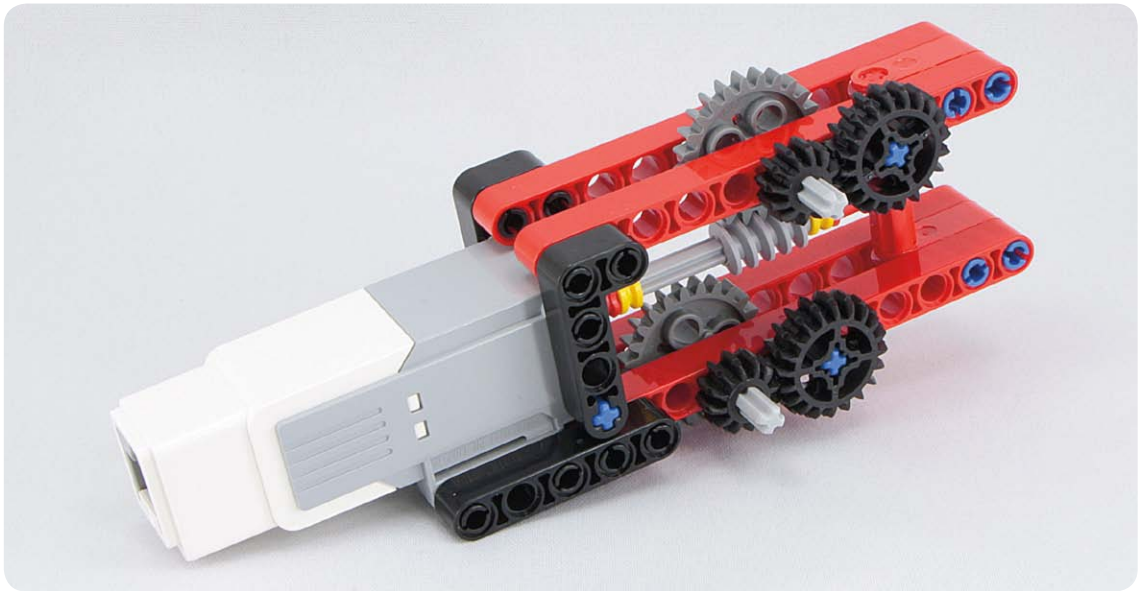
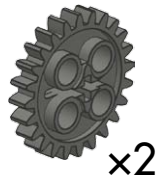
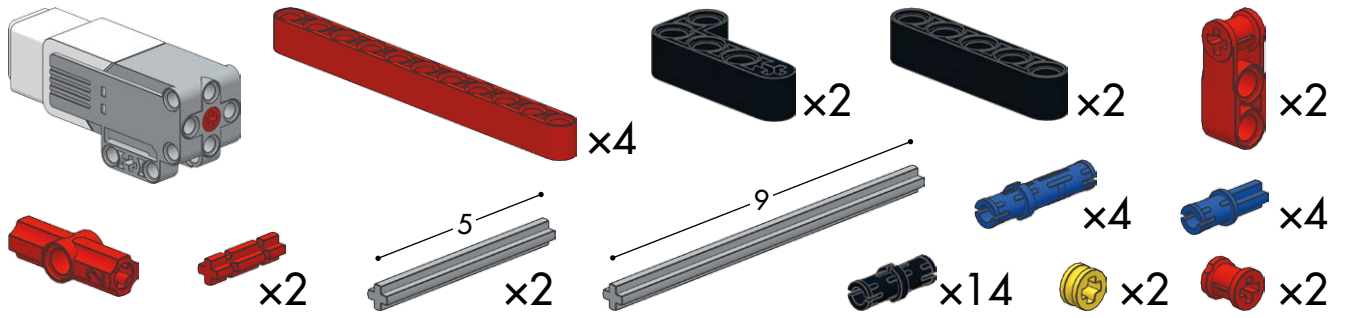

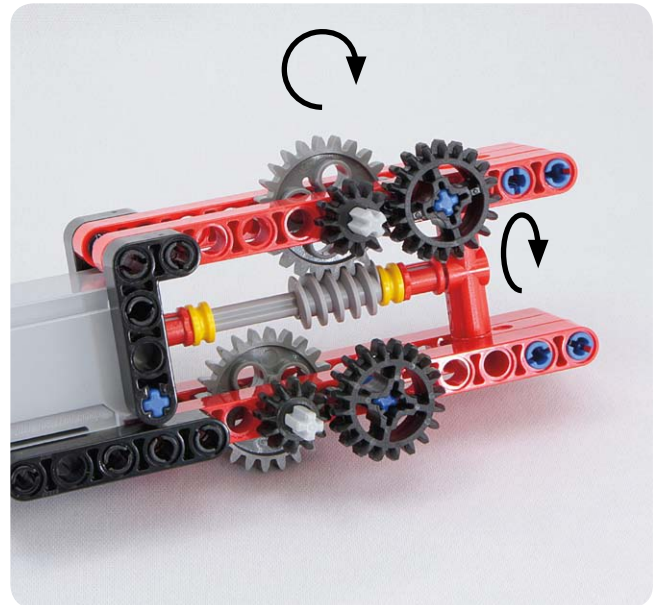
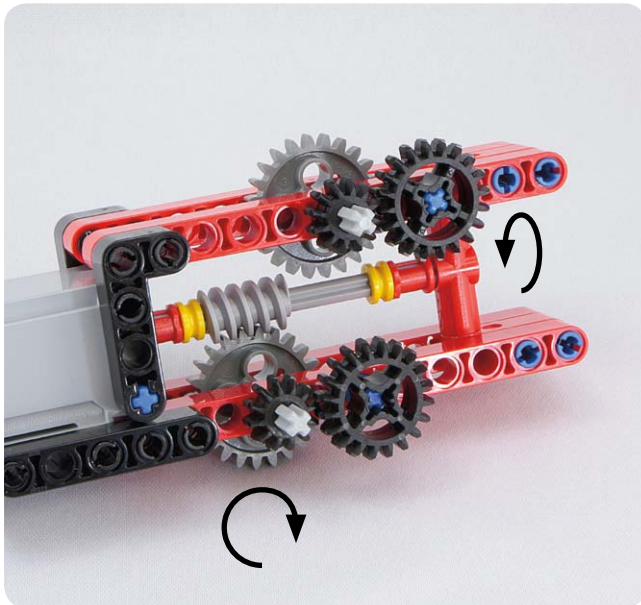
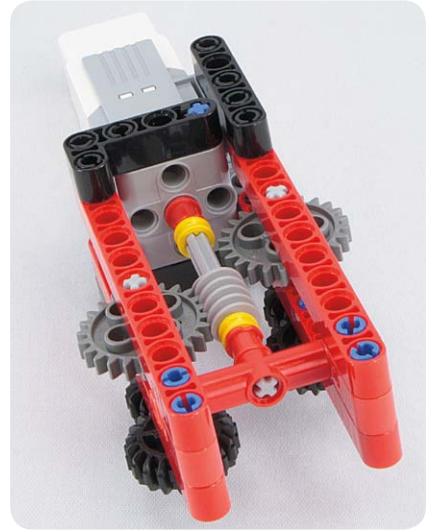
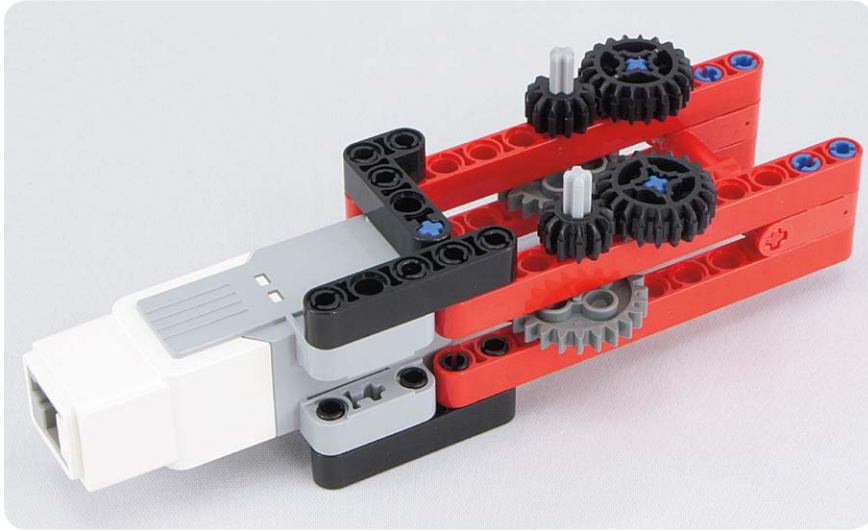
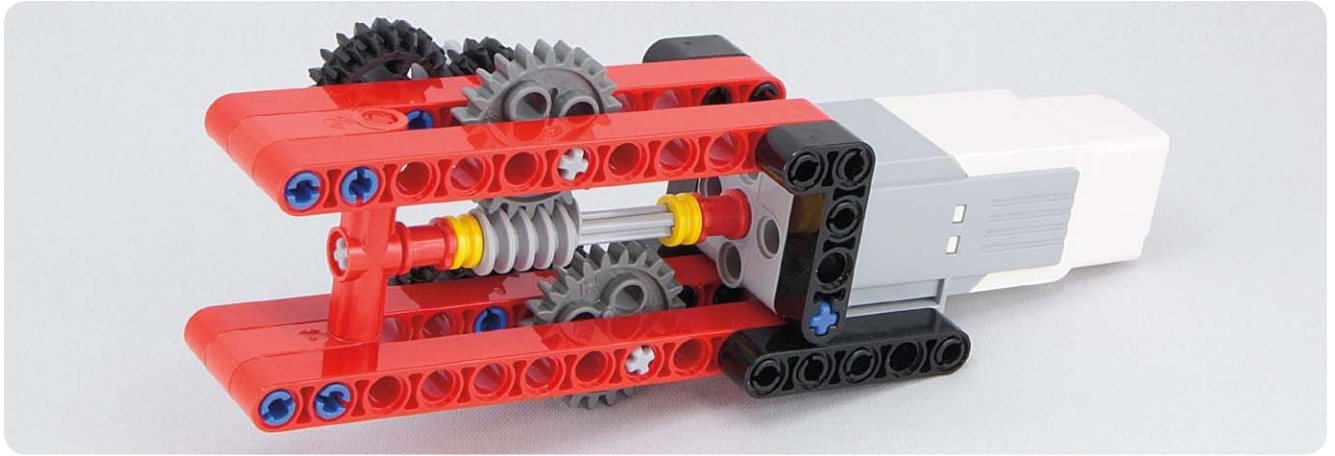

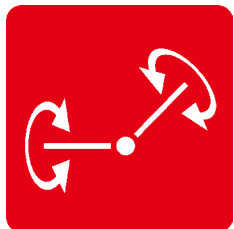





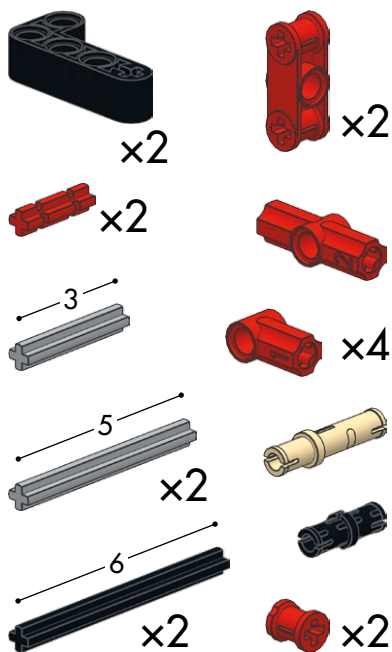





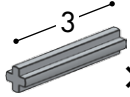
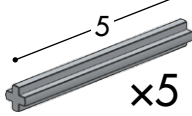

Universal joints

#100



#101

-  x2
-  x6
-  x6
-  x2
-  x5
-  x2
-  x4
-  x2
-  x2
-  x2
-  x1
-  x2



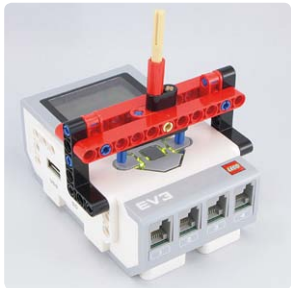

PART 2

● ○ ○ ○ ○ ○

Vehicles



78



90

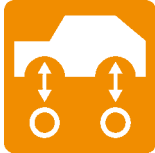

100

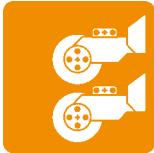

82

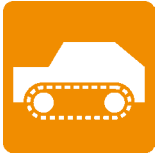

94



104

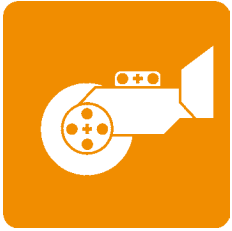

Driving wheels with a motor

#102

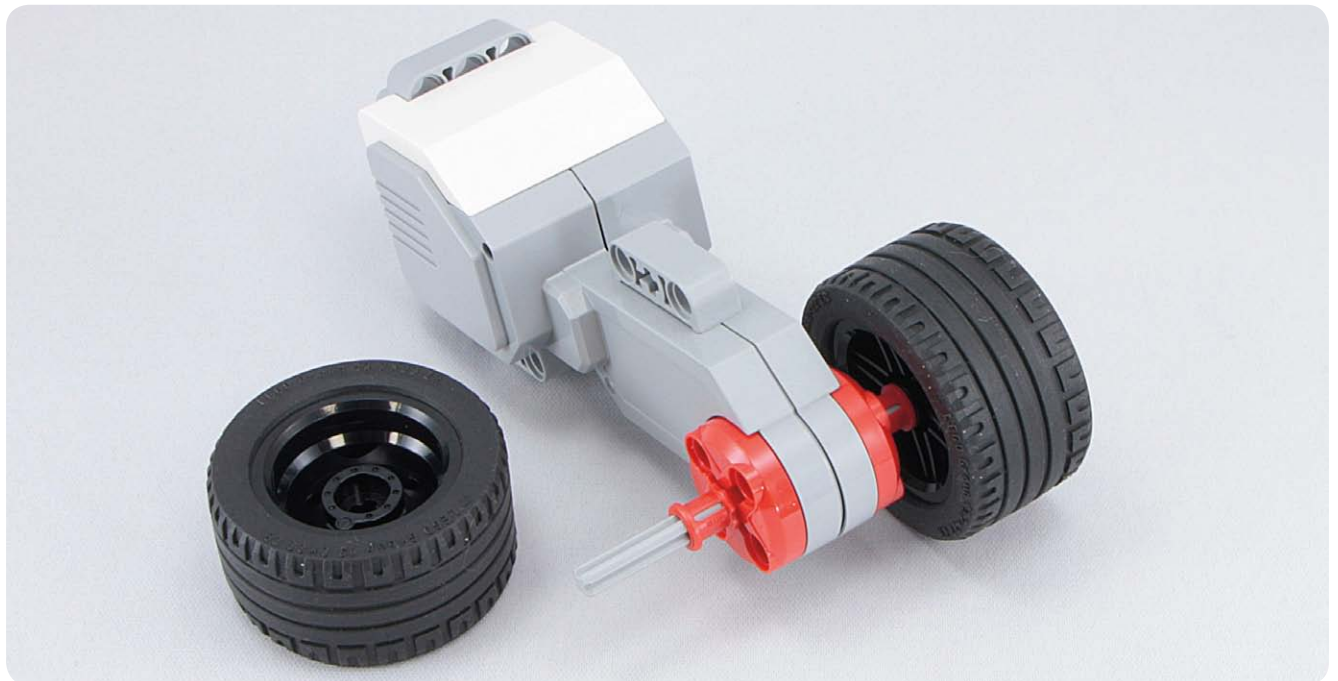
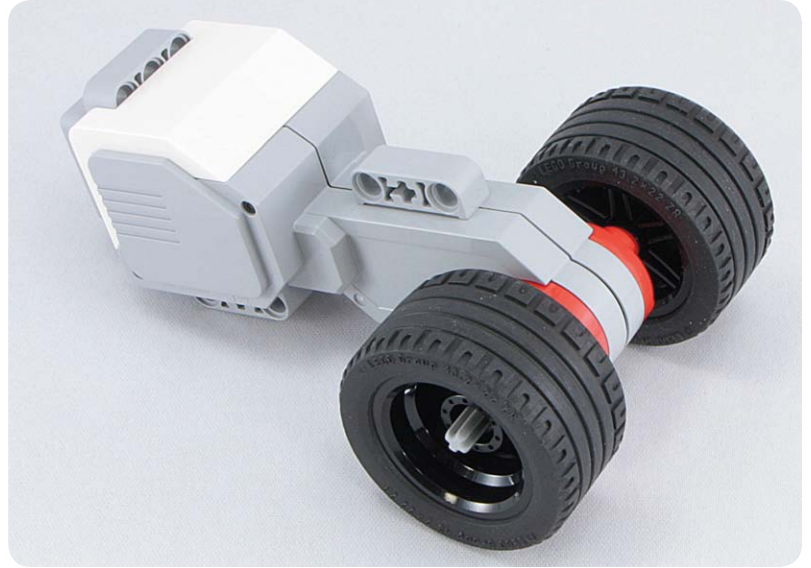
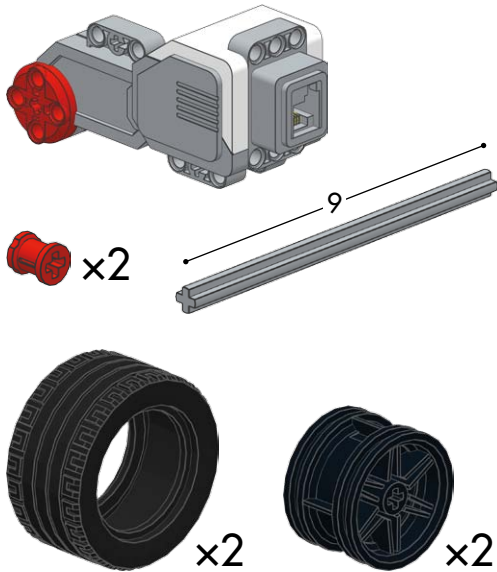

#103

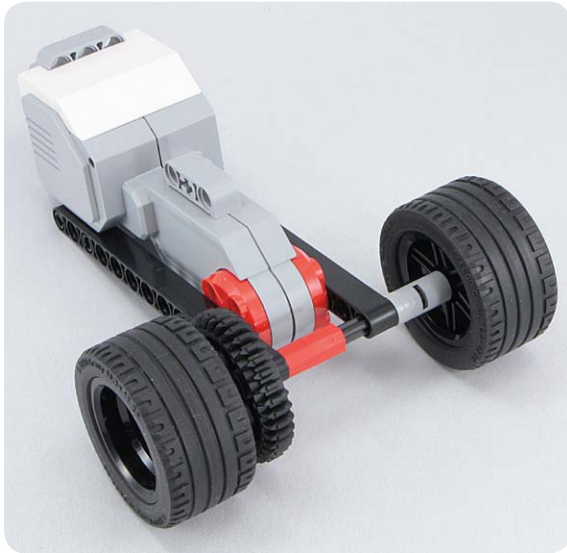

#104

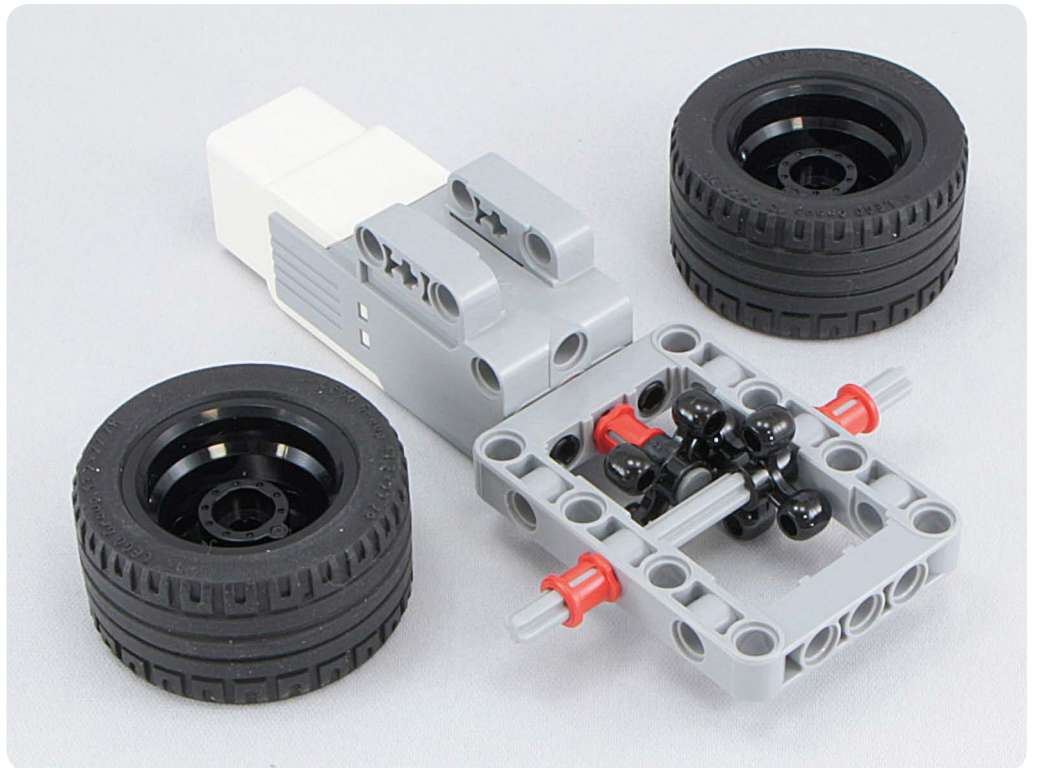
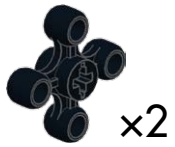
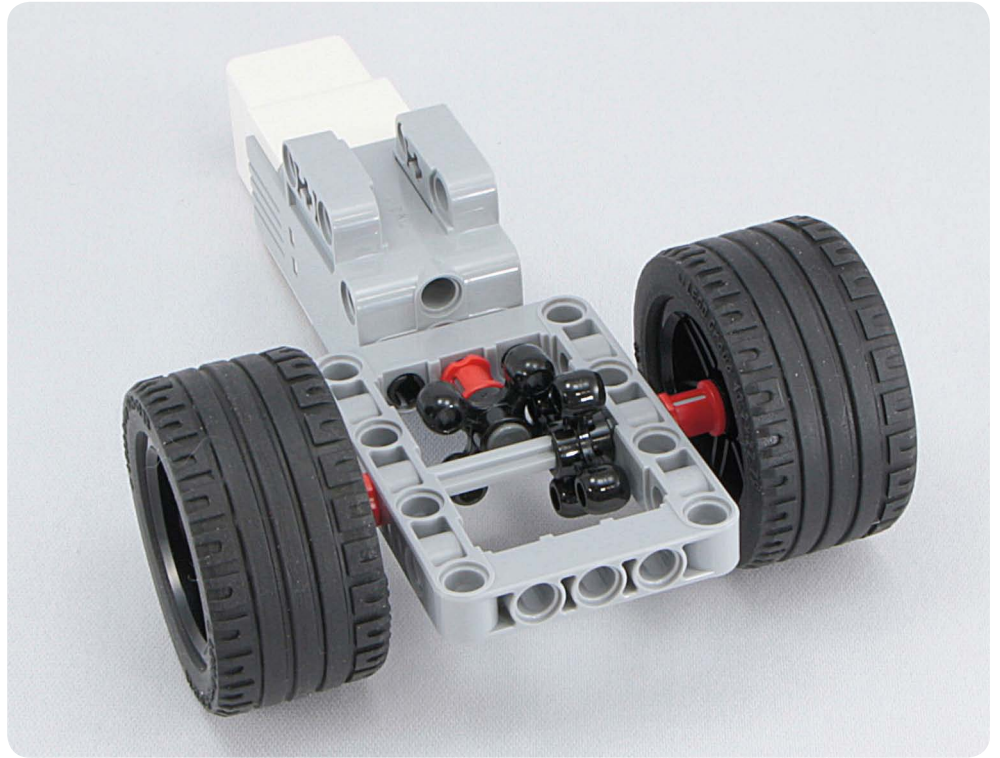
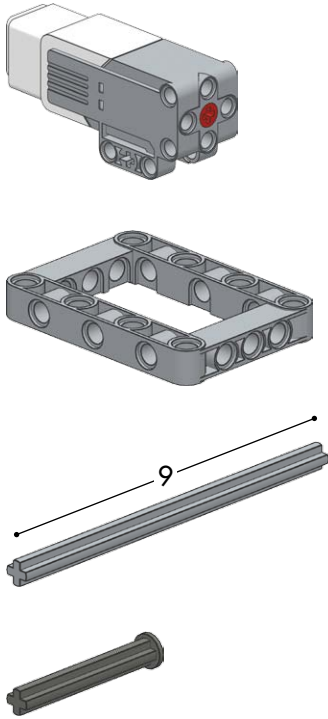

#105

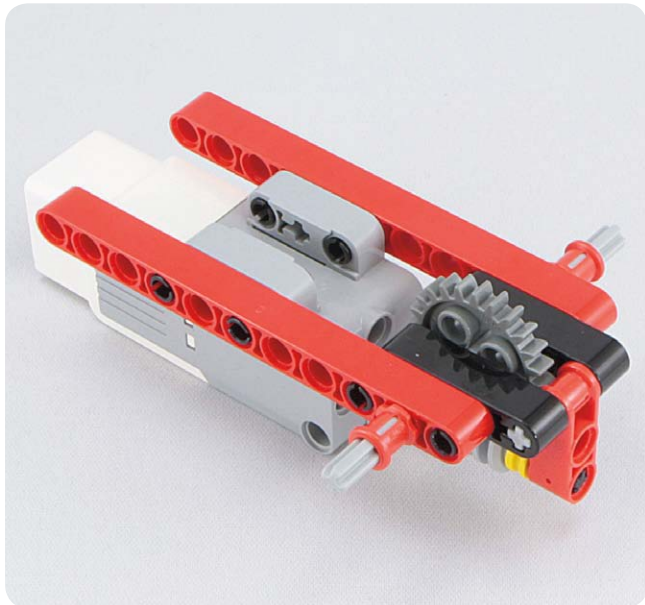
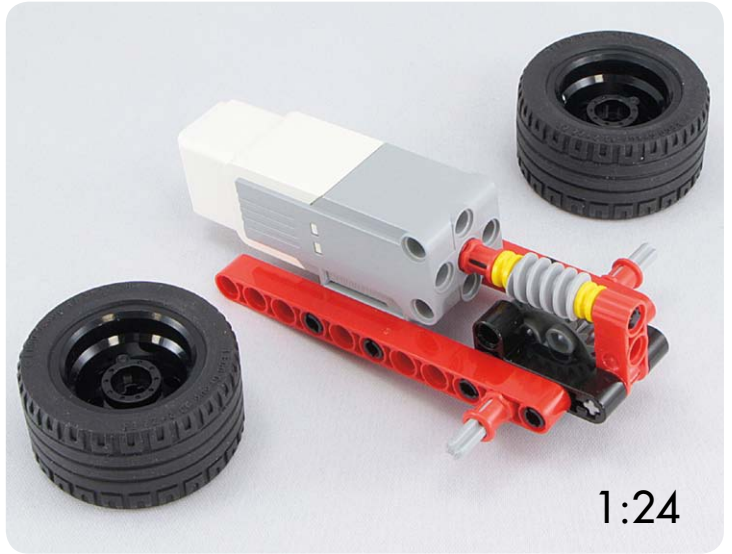
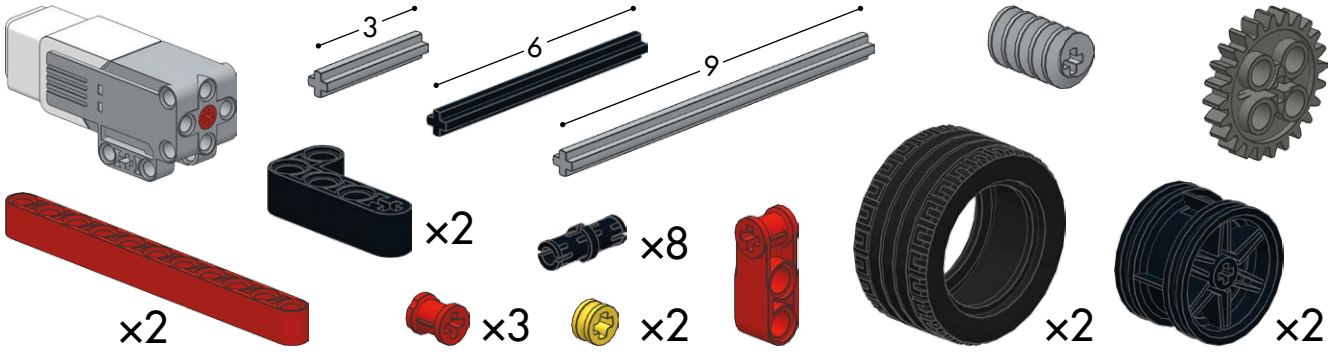

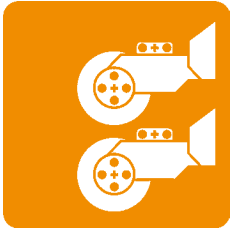

Driving wheels with two motors

#106

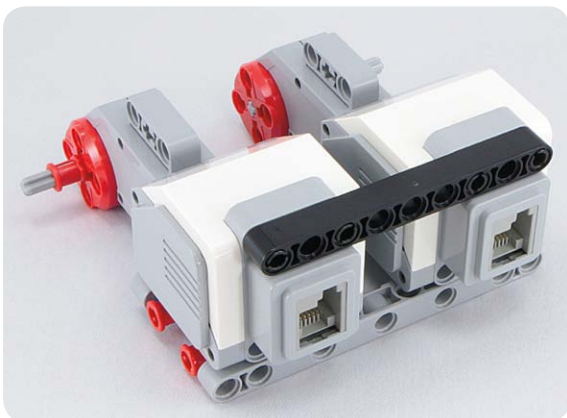
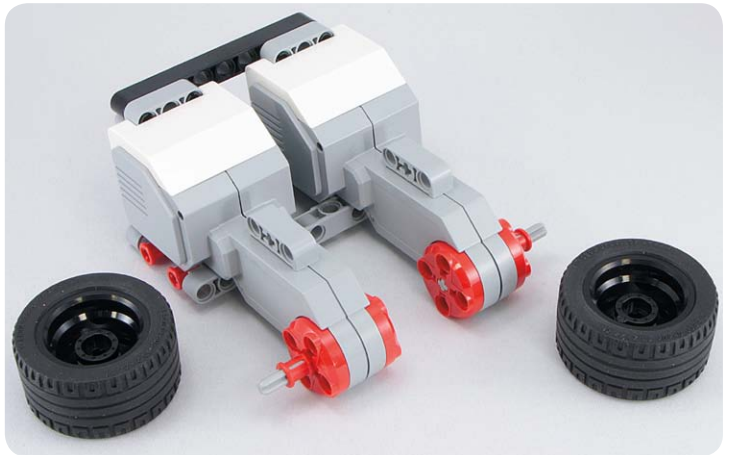
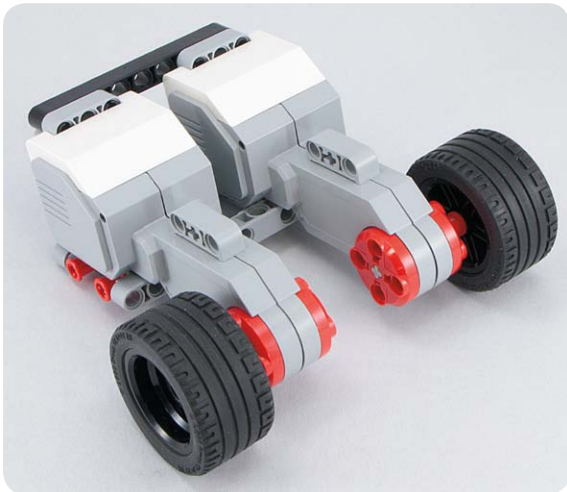
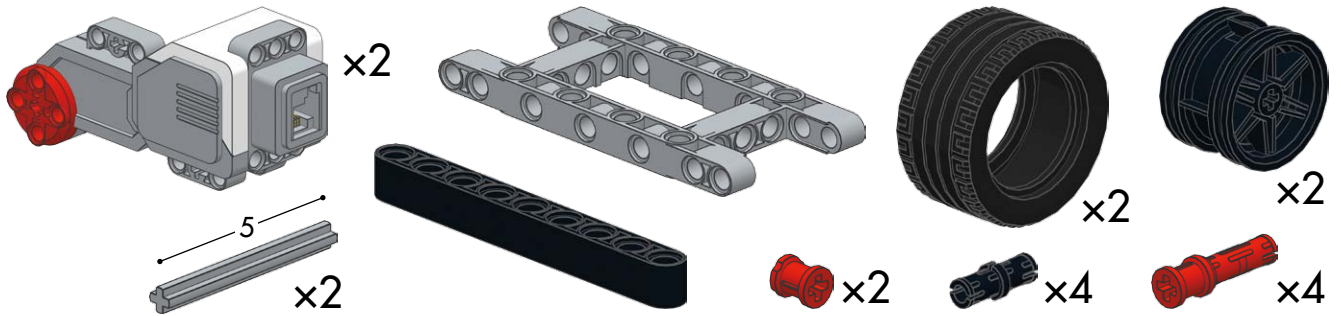

#107

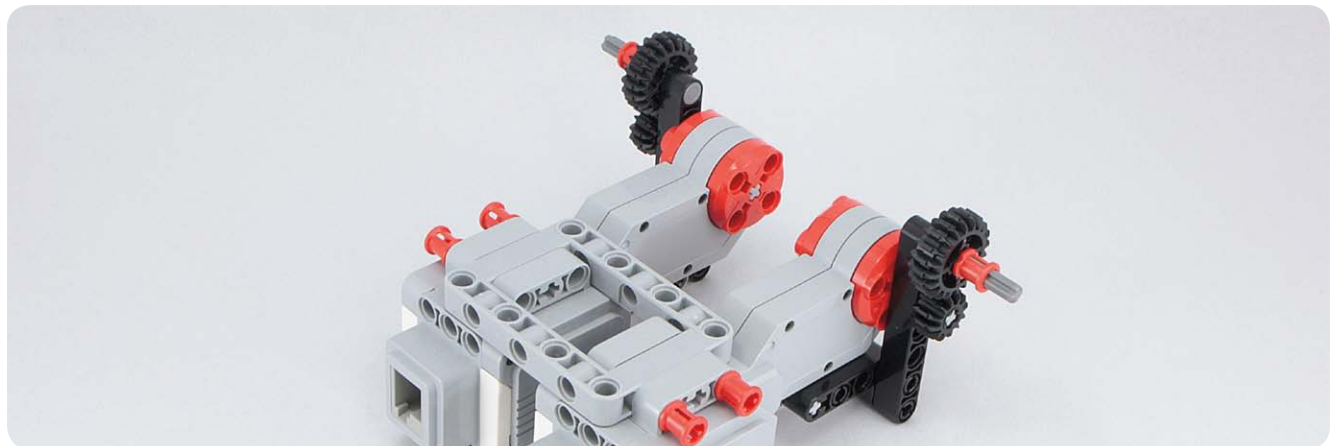
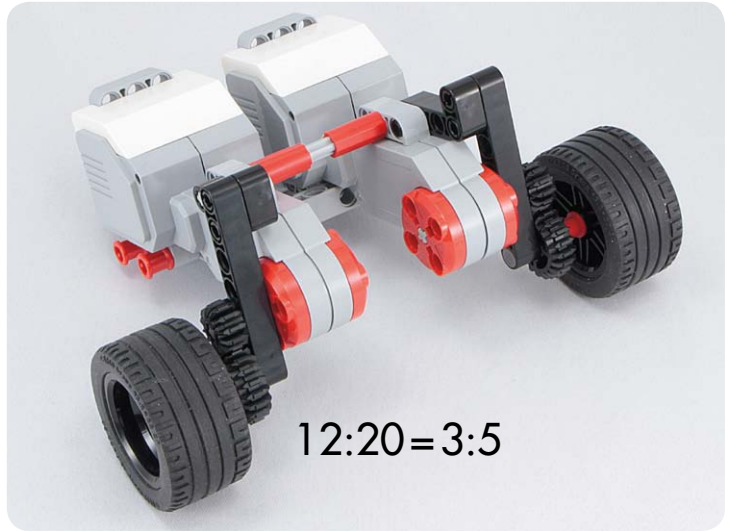

#108

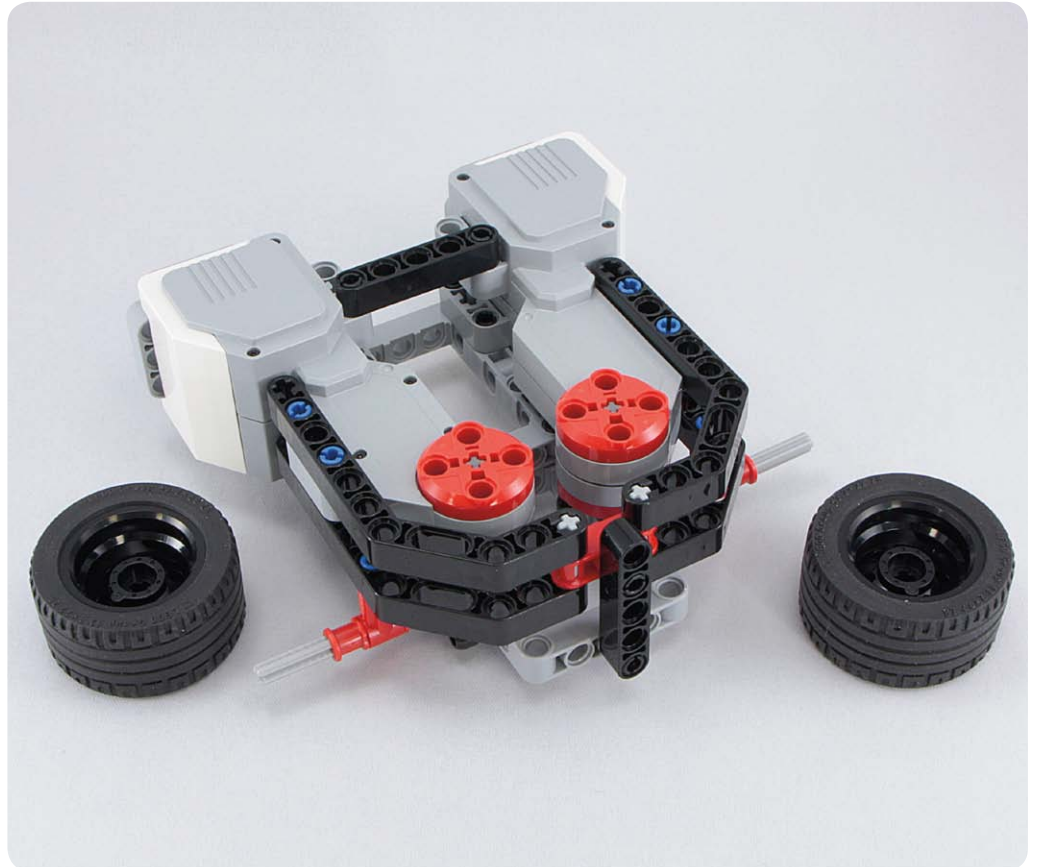
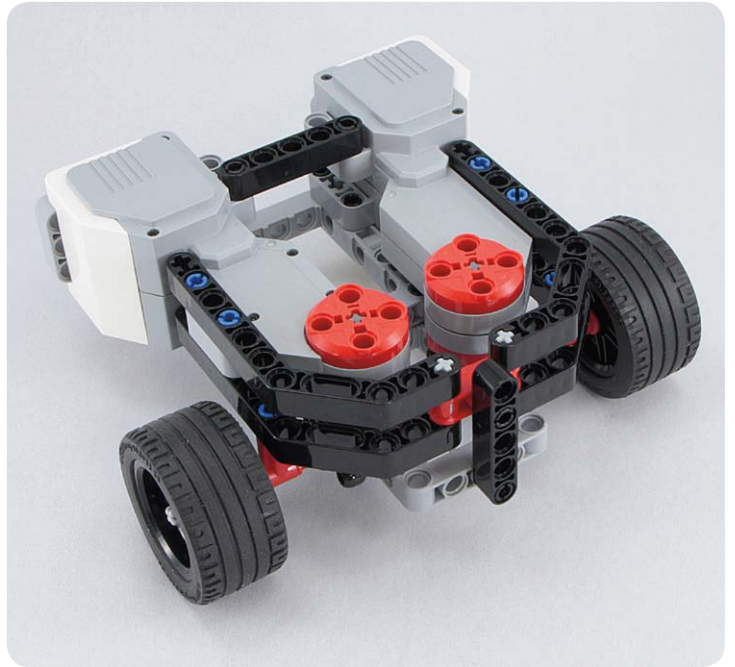
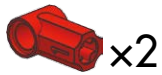
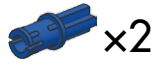
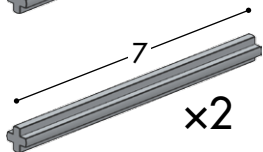
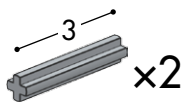
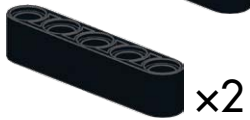
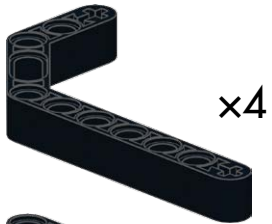
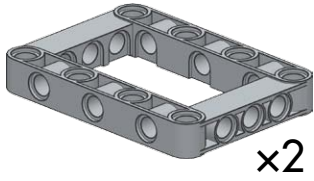
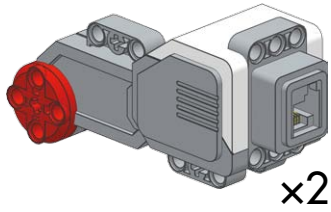

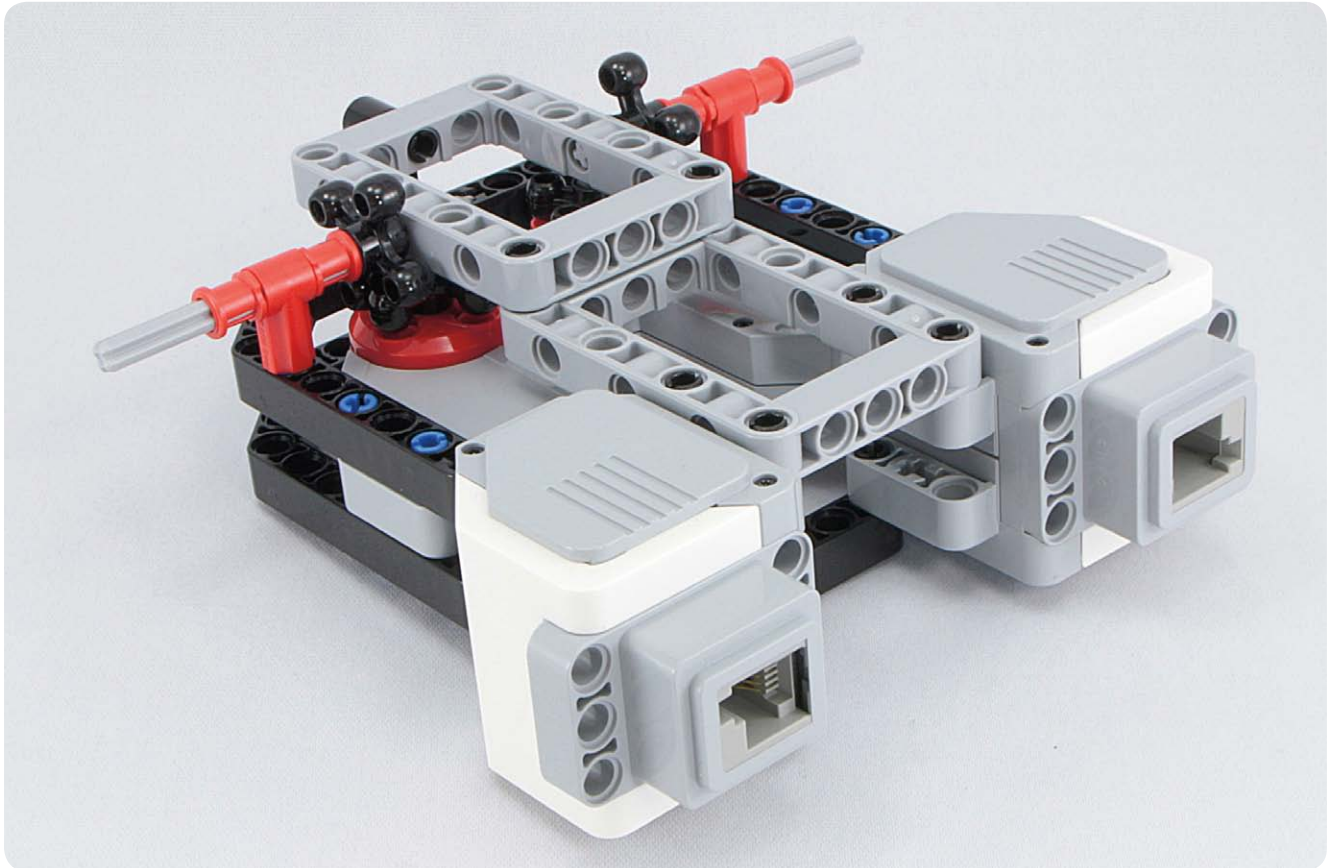
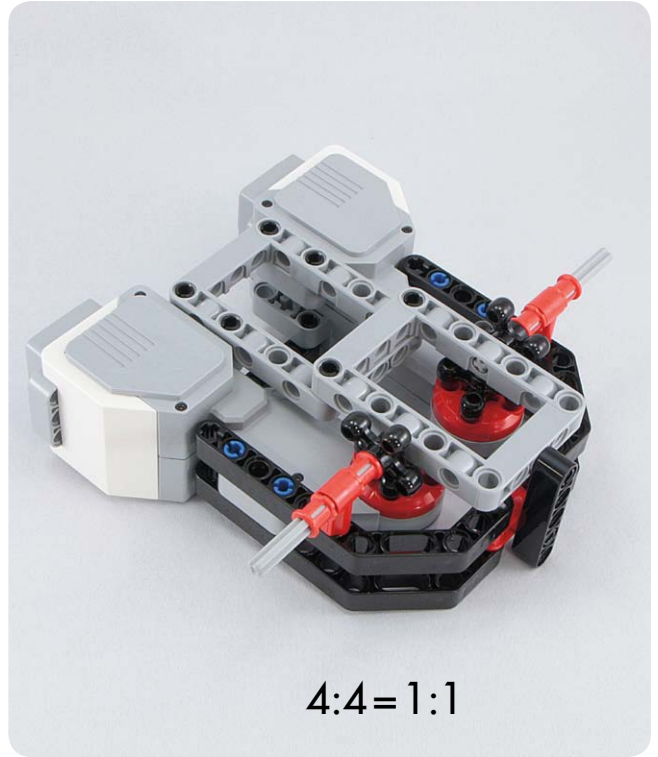

#109

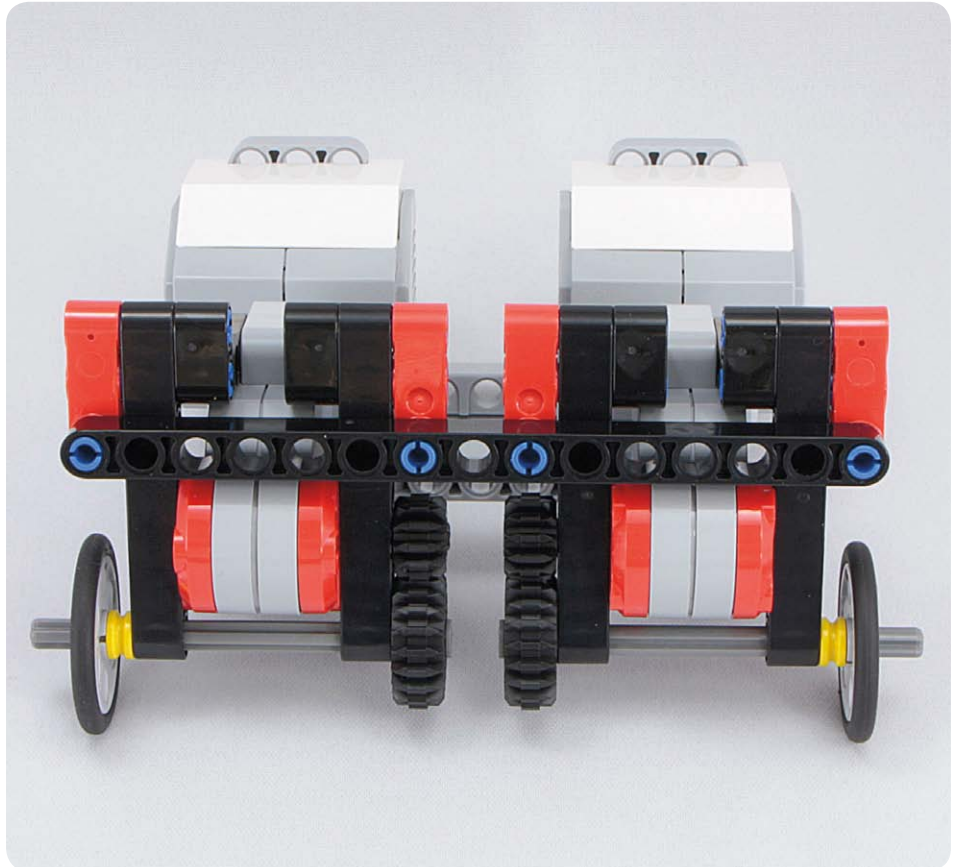
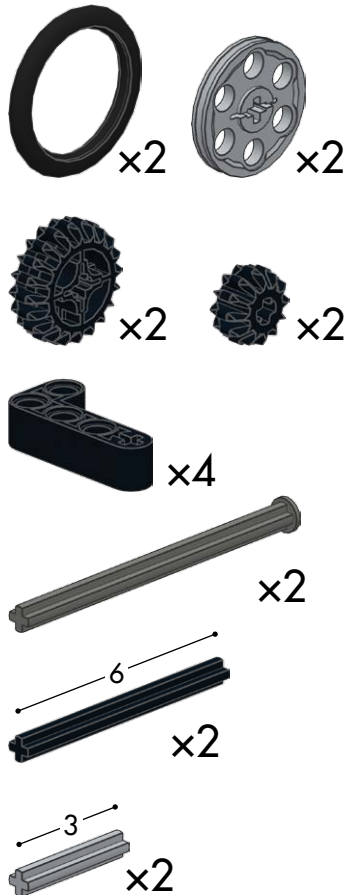
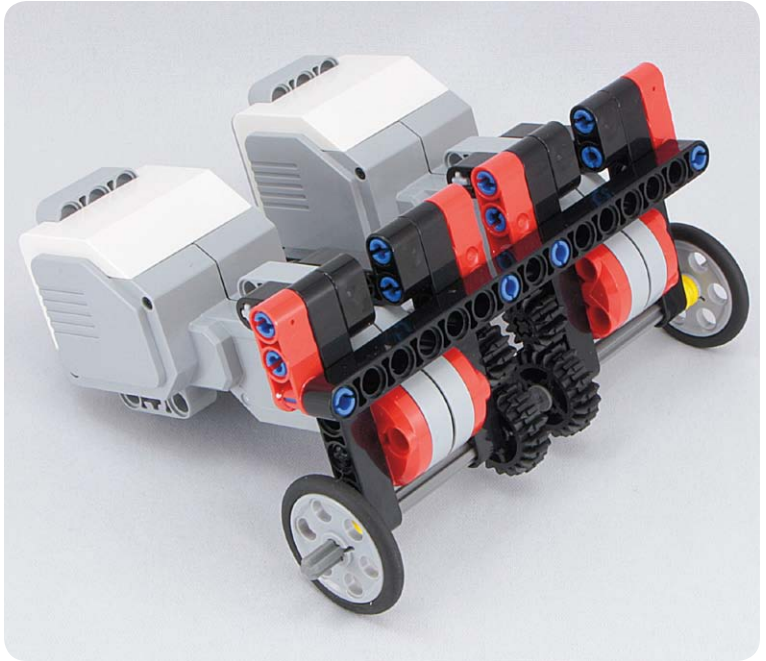
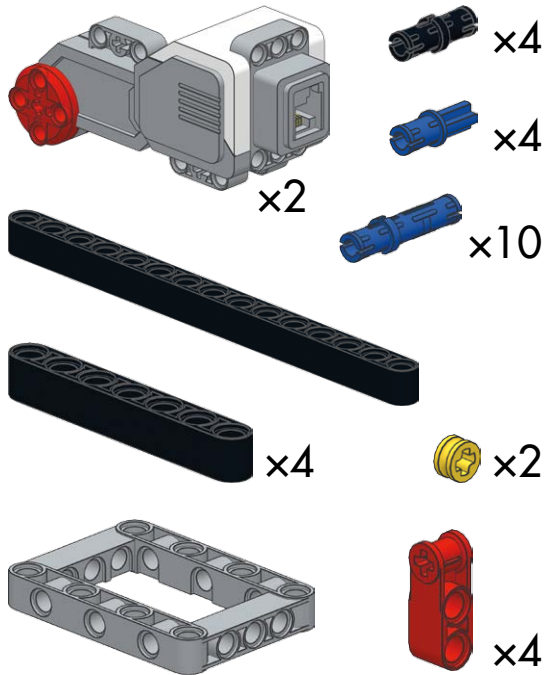

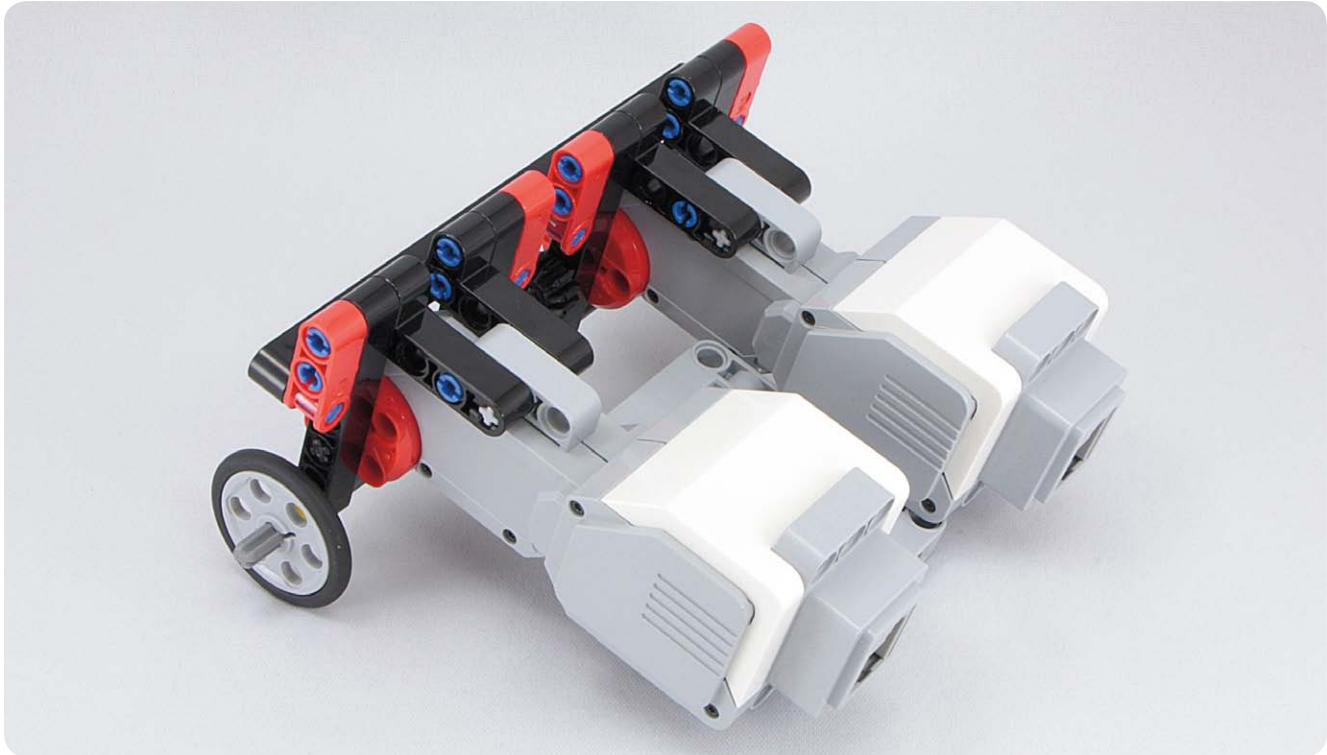

#110

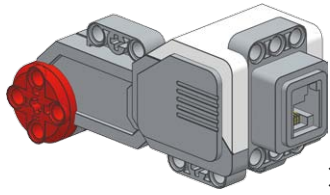

x2

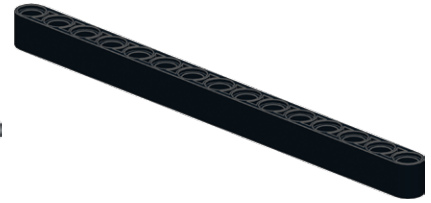
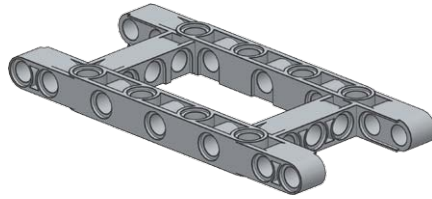

x4



x2



x2



x2

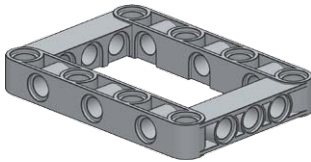

x2



x2



x2

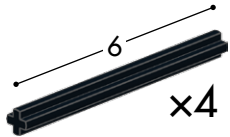

x4

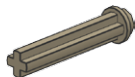

x2



x8



x6



x2



x4

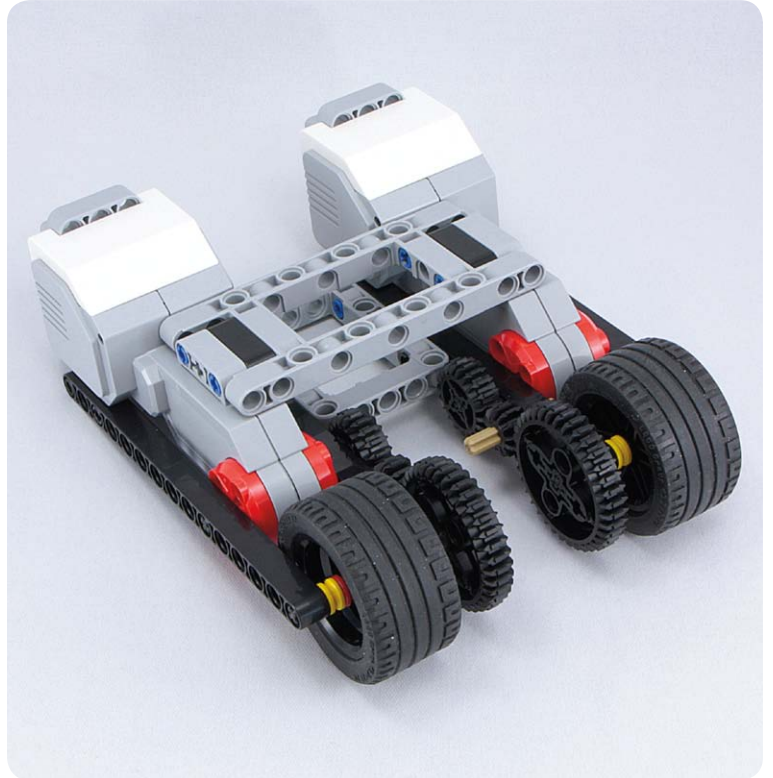

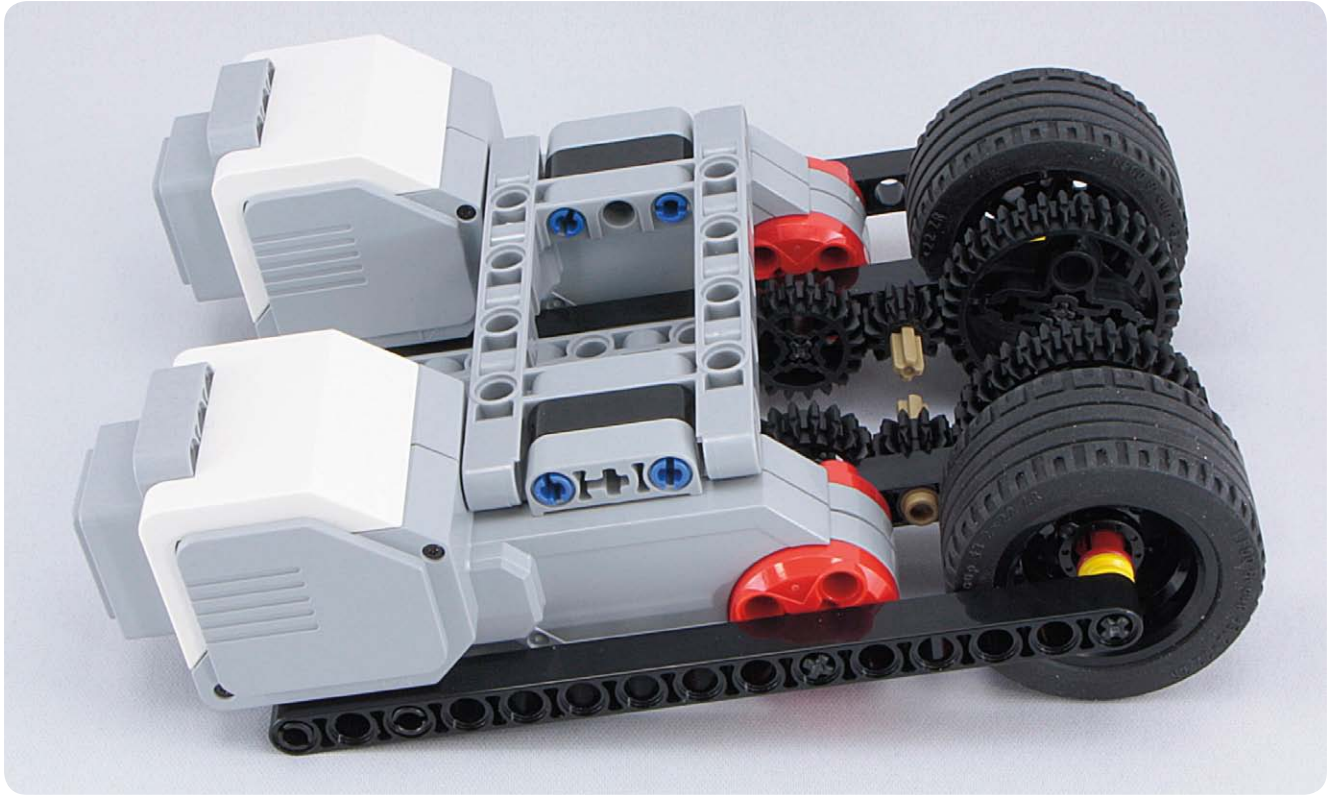

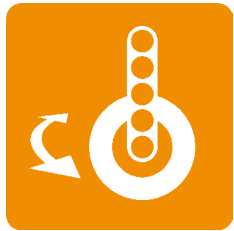

Caster wheels

#111

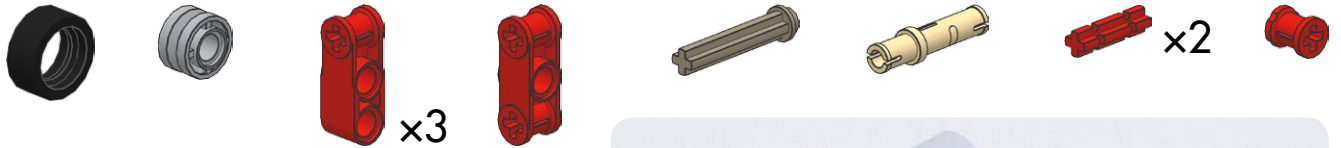

#112

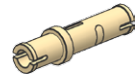
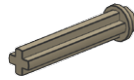

#113

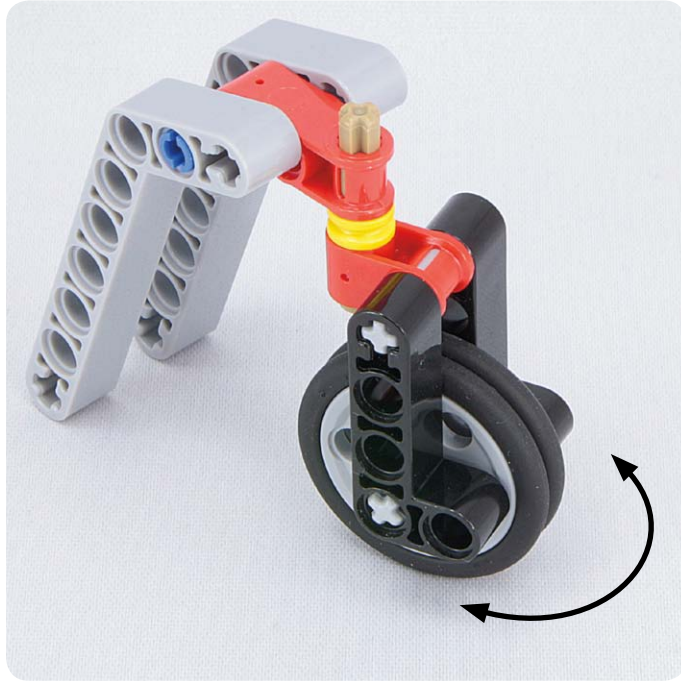
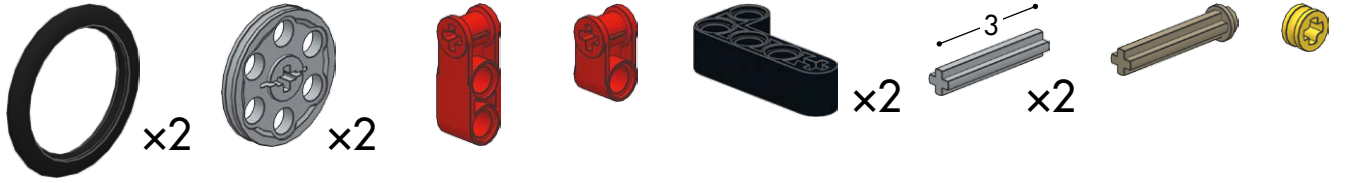

#114

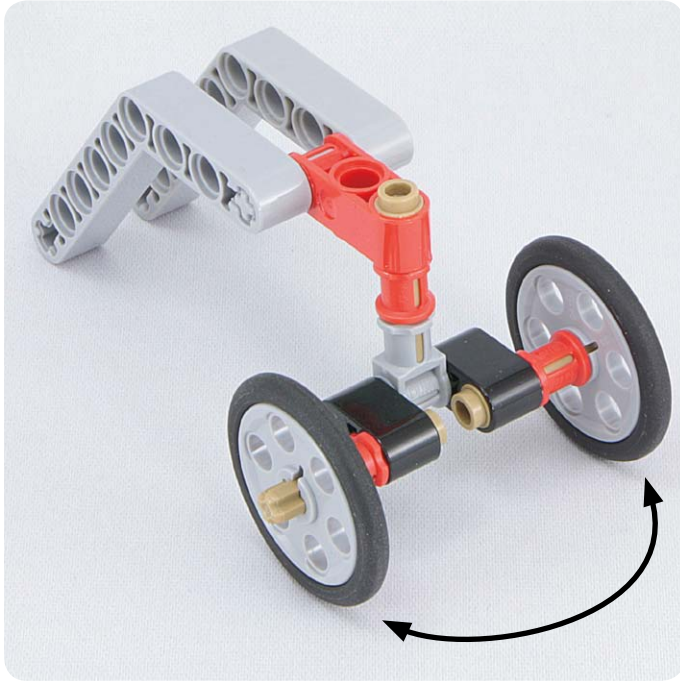
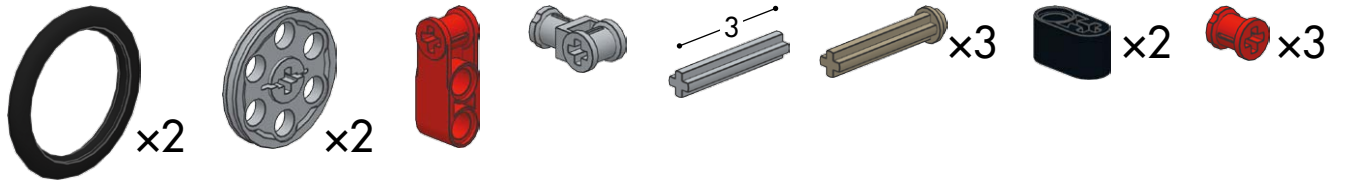

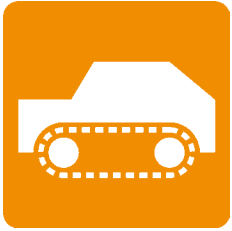

Crawlers

#115

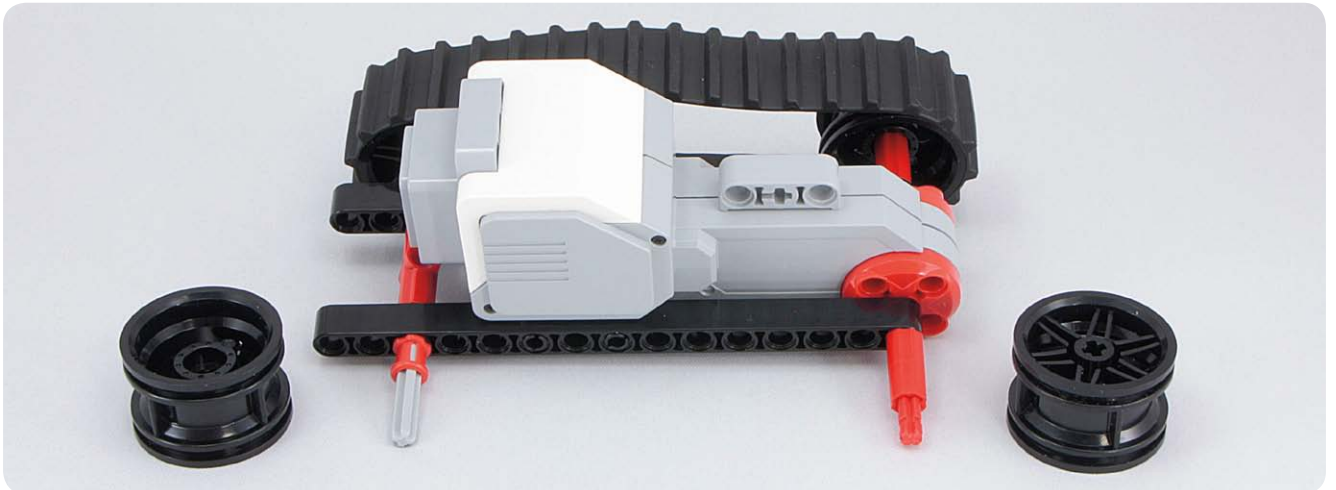
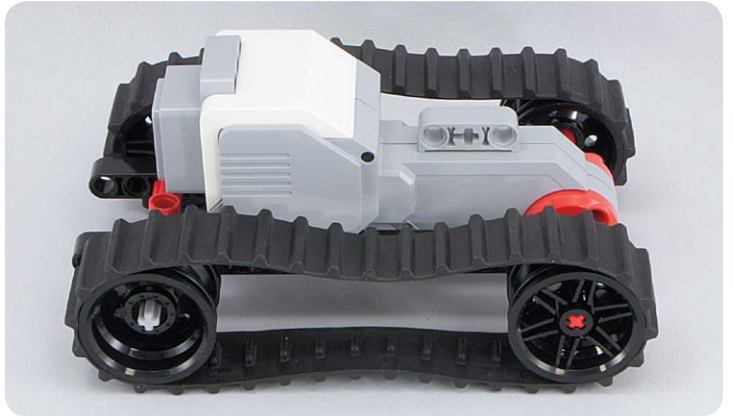
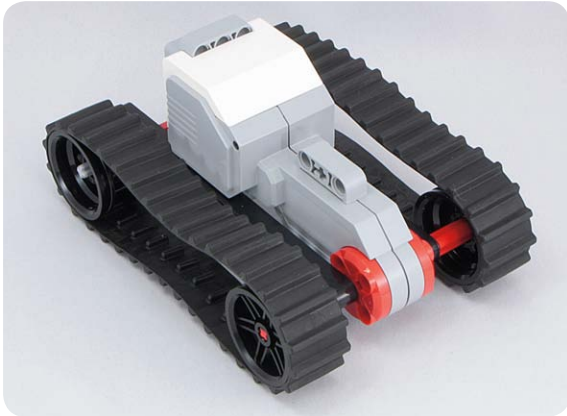
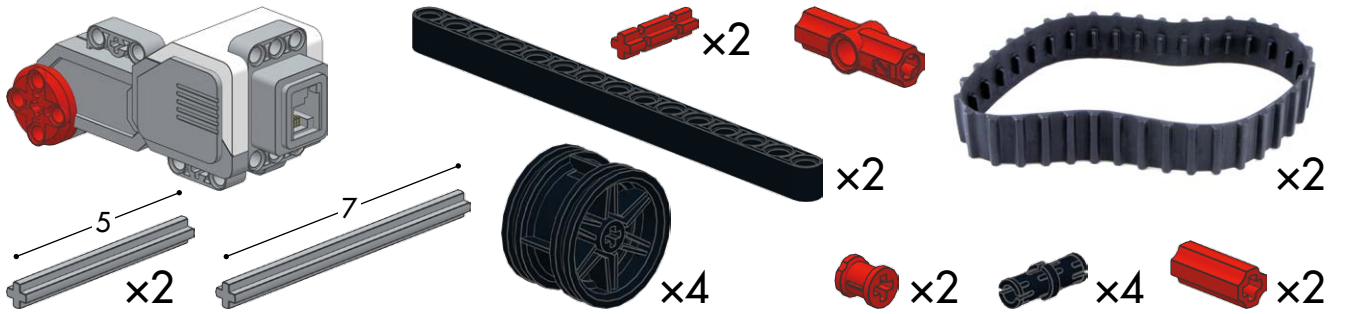

#116

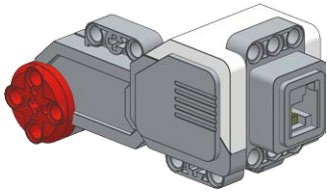

x2



x2



x2



x2

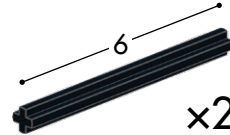

x2



x2

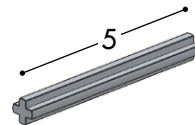

5



x8



x2

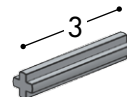

3



x4

$$20:12:20 = 5:3:5$$



#117

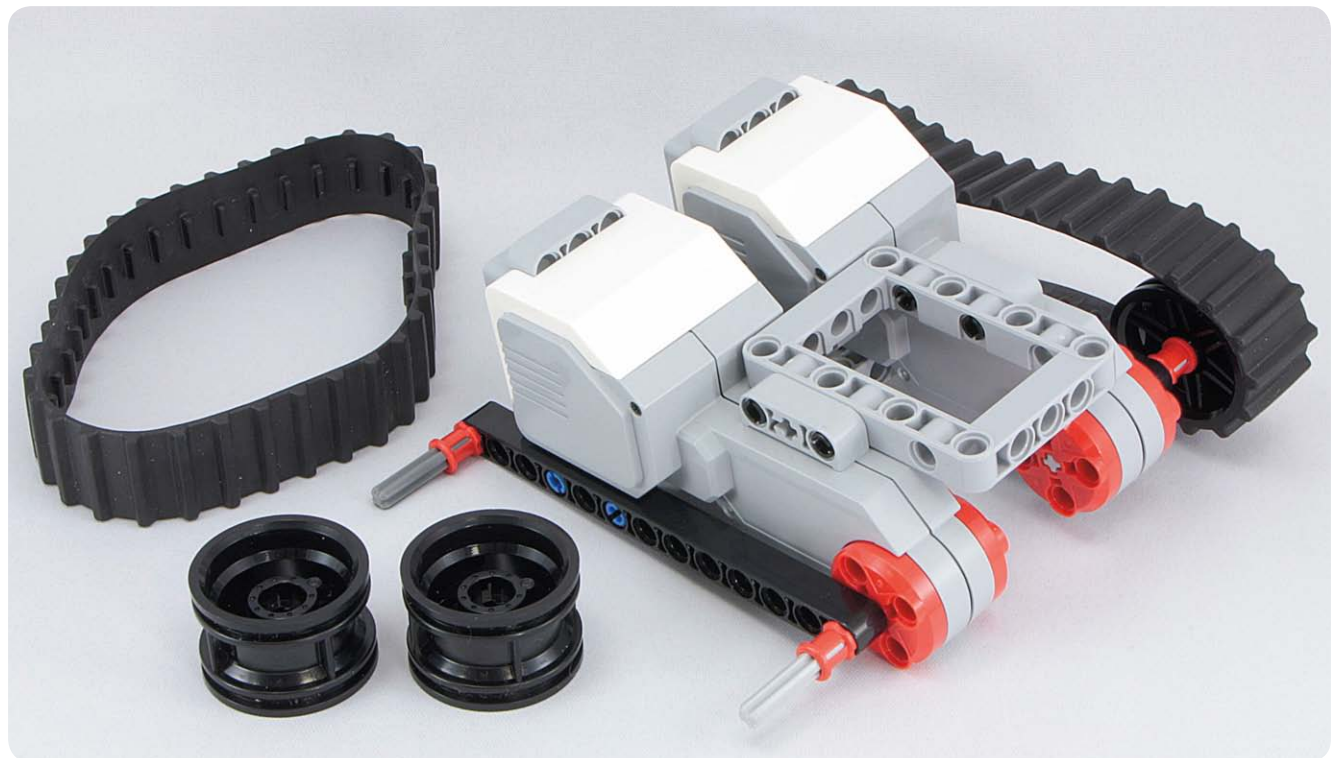
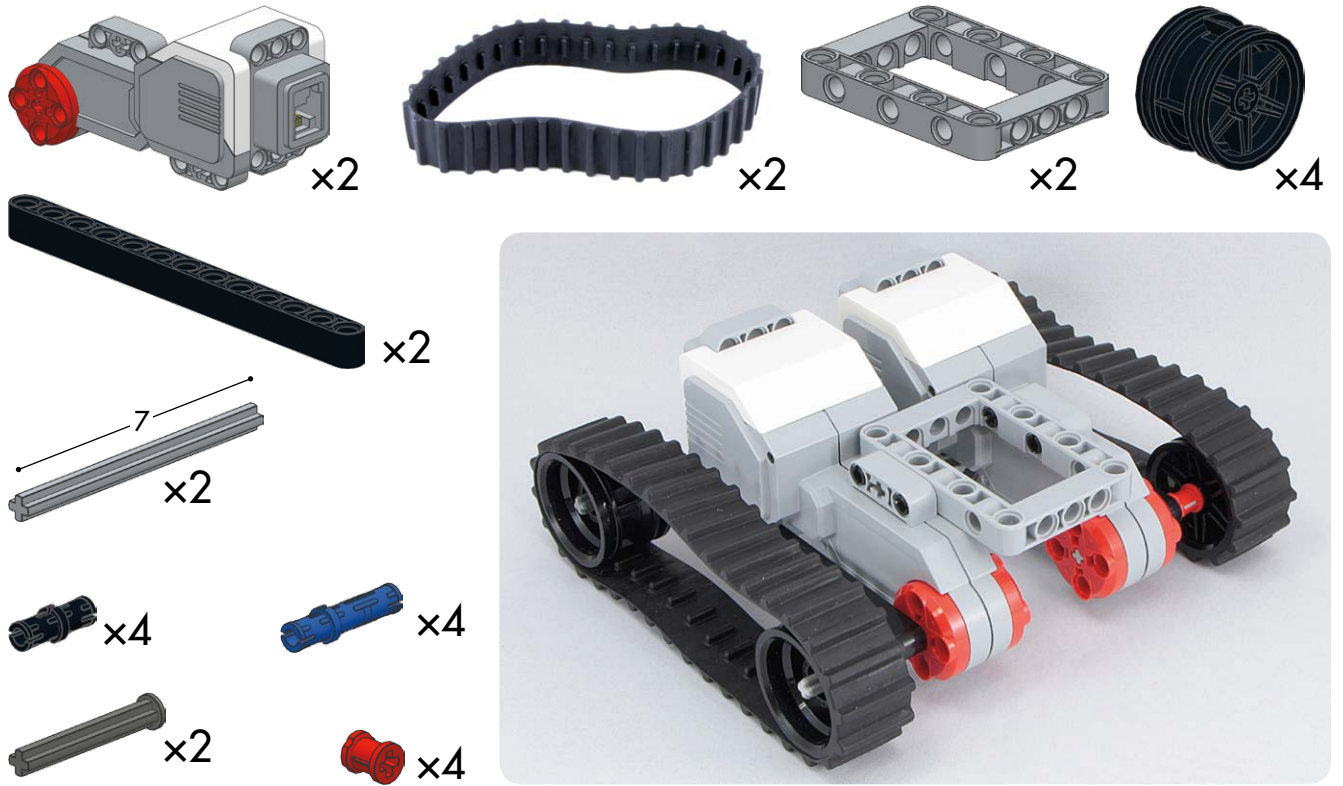

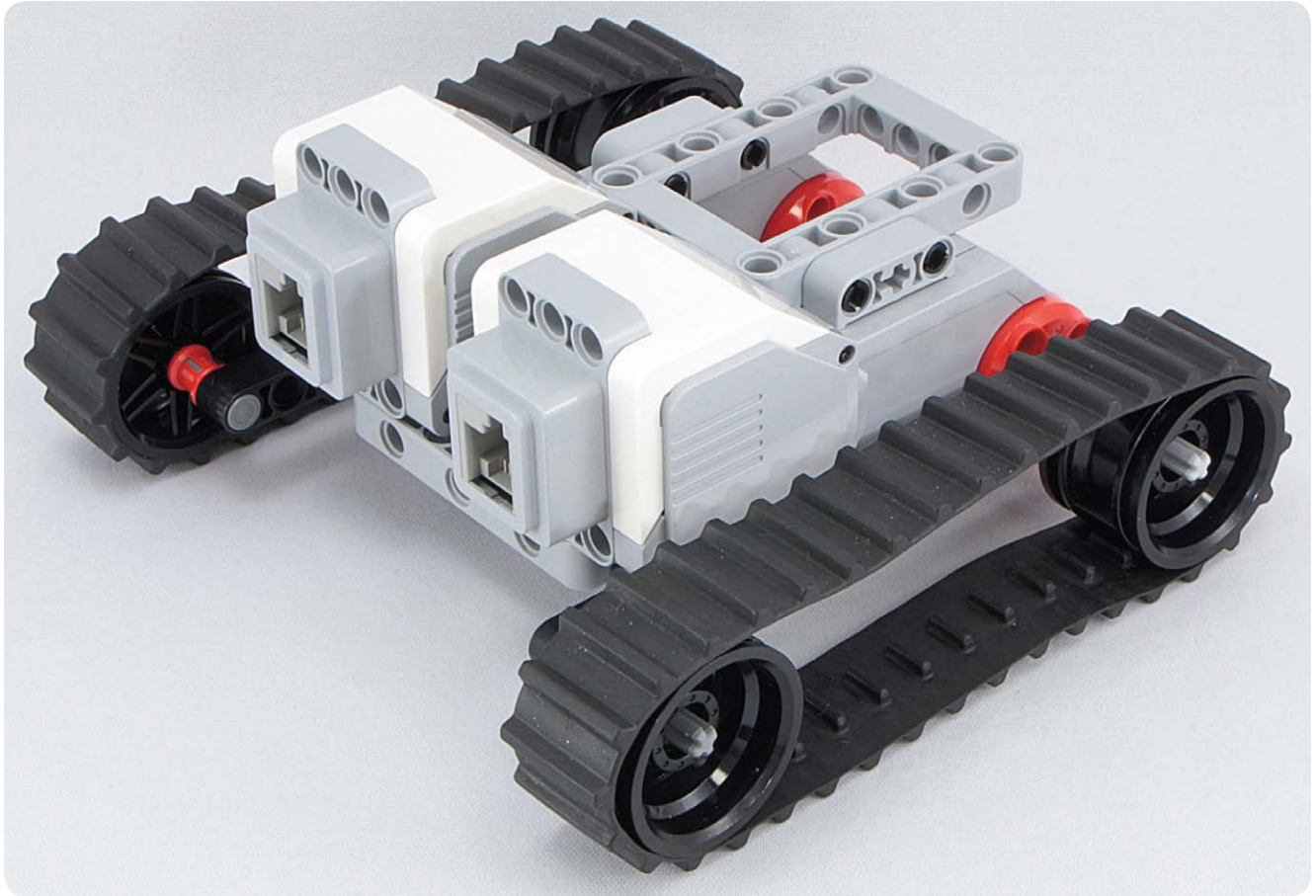

#118

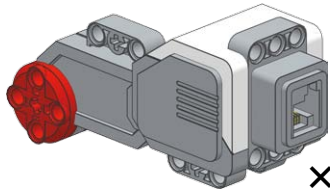

x2



x2



x4

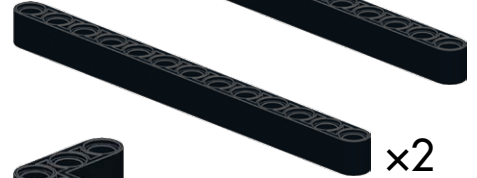
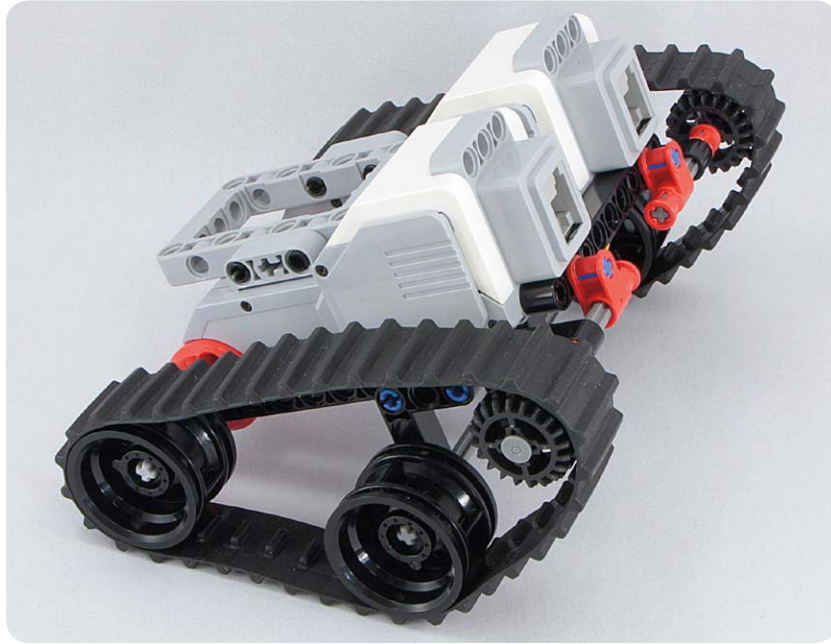
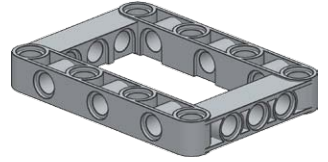

x2



x4



x4

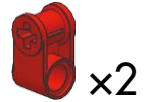

x2

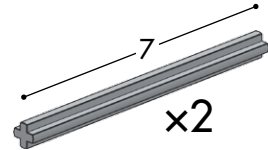

x2



x4

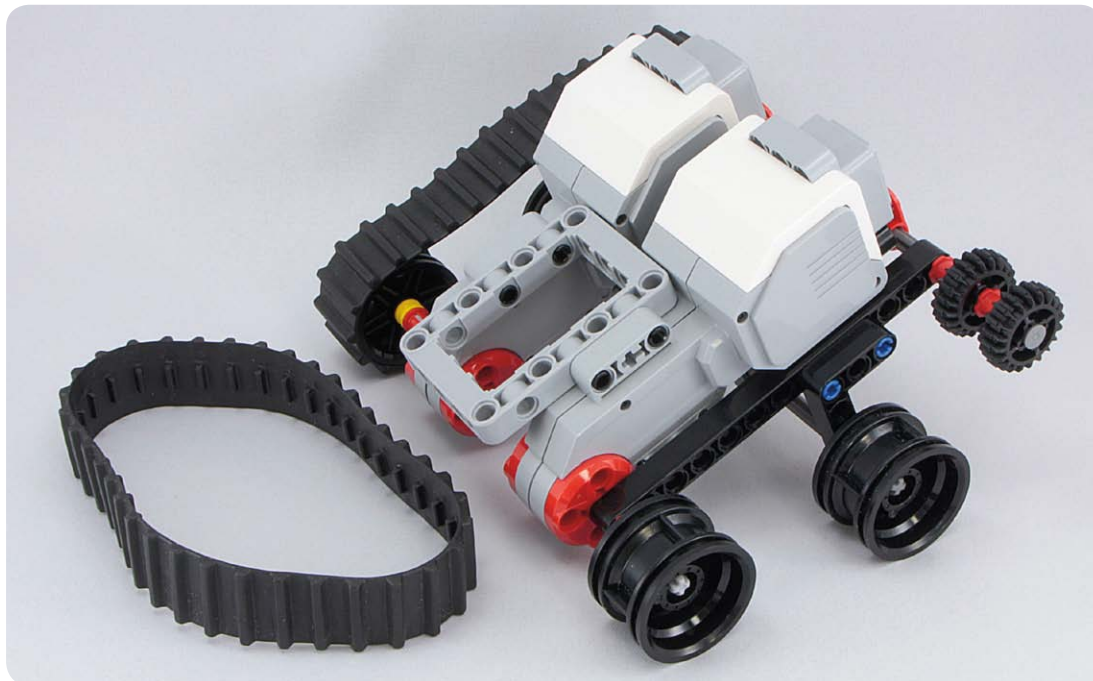

x12



x2



x4



x8



x4

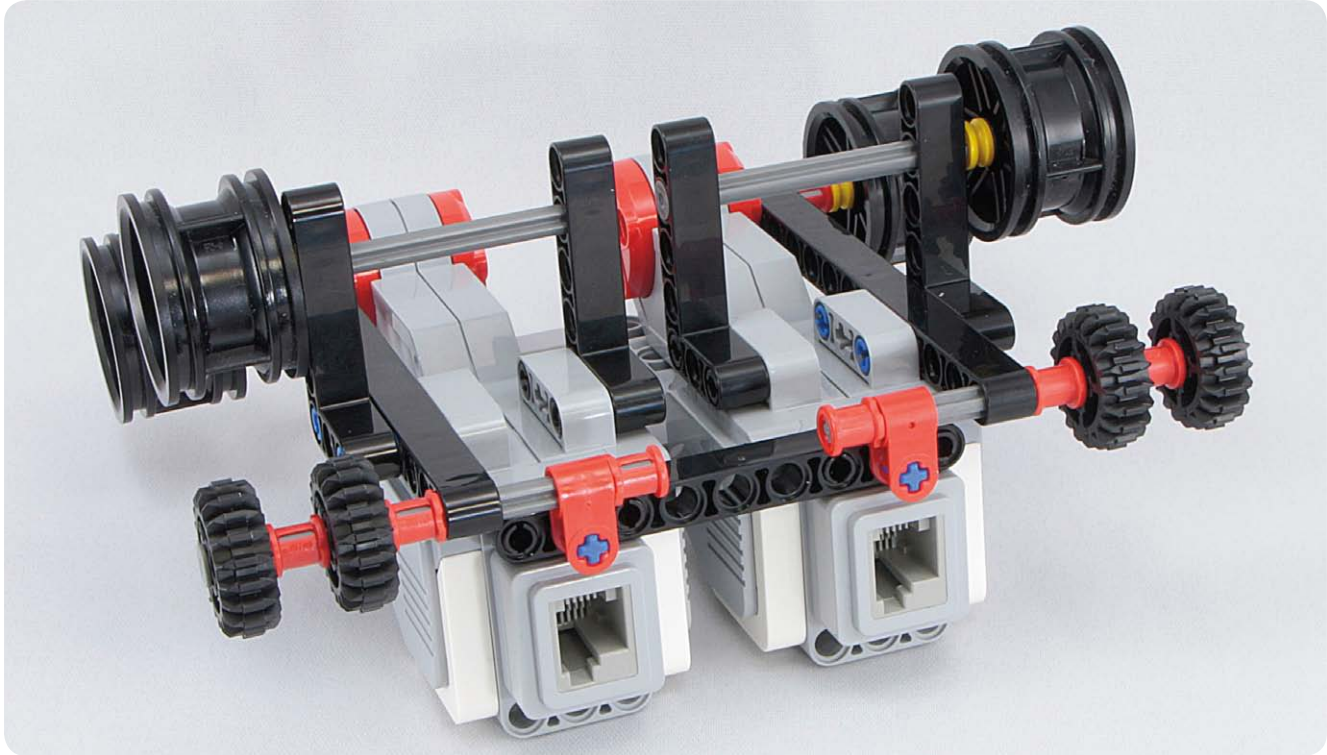

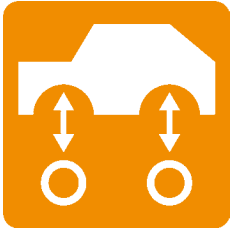

Suspended wheels

#119

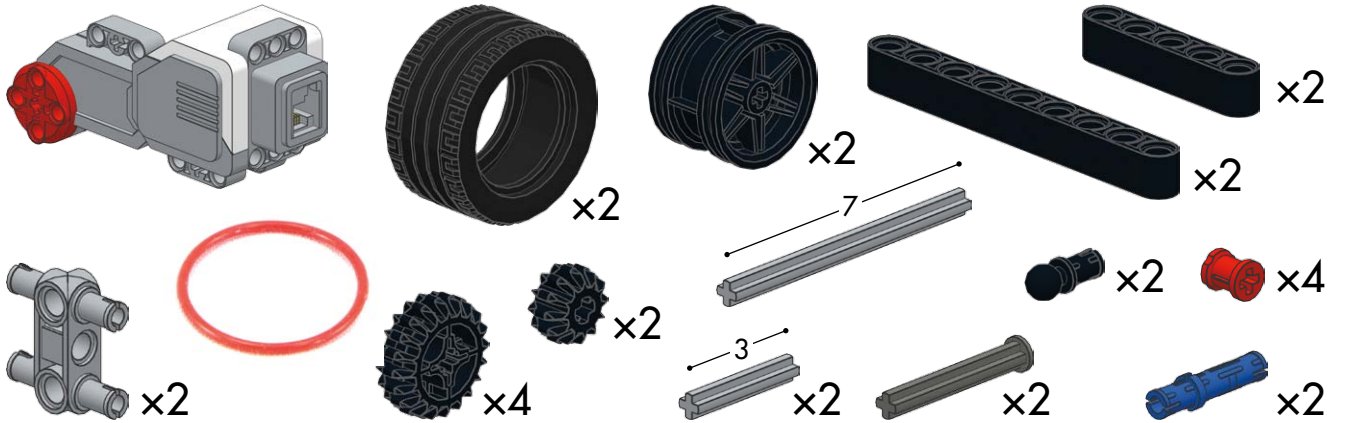

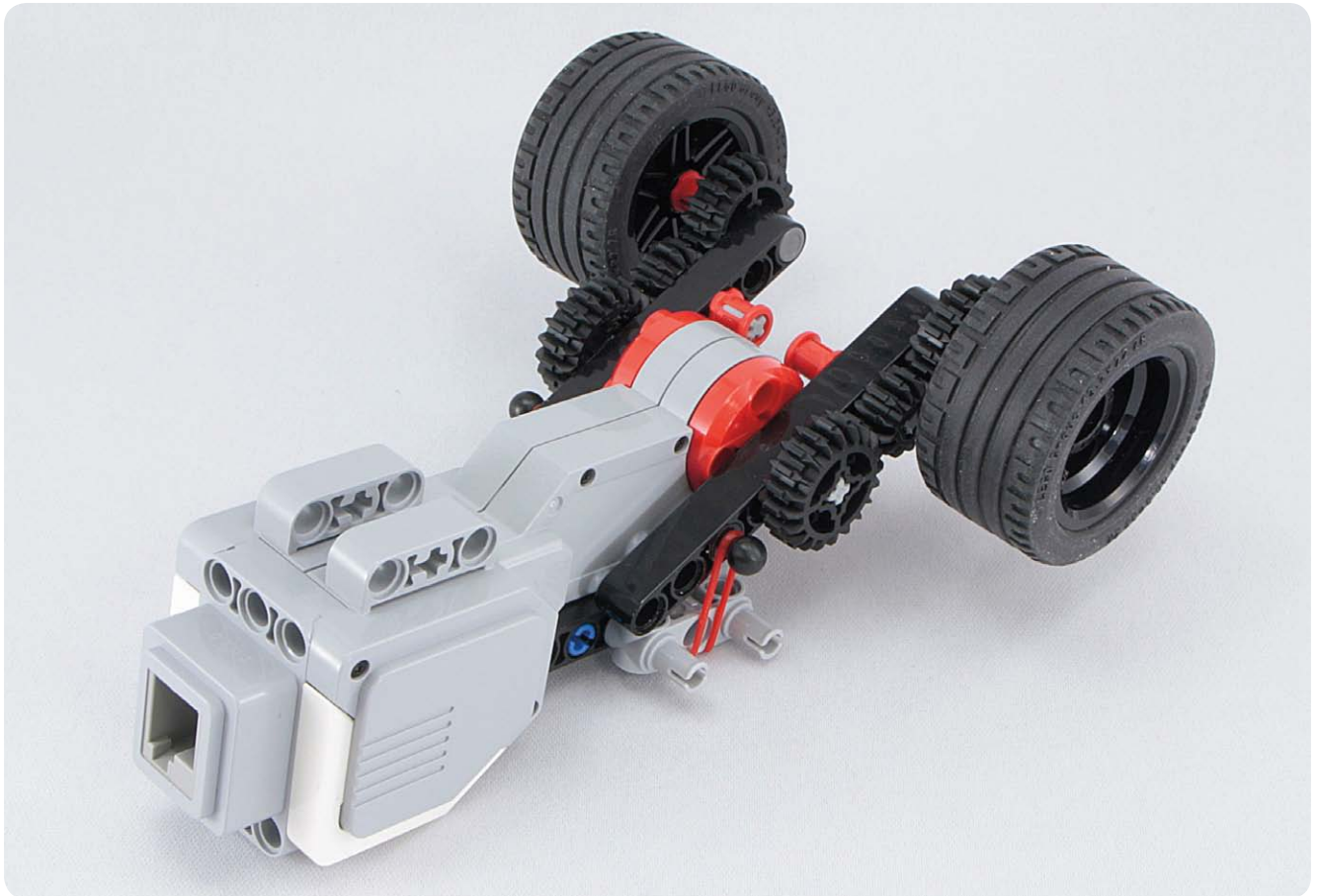
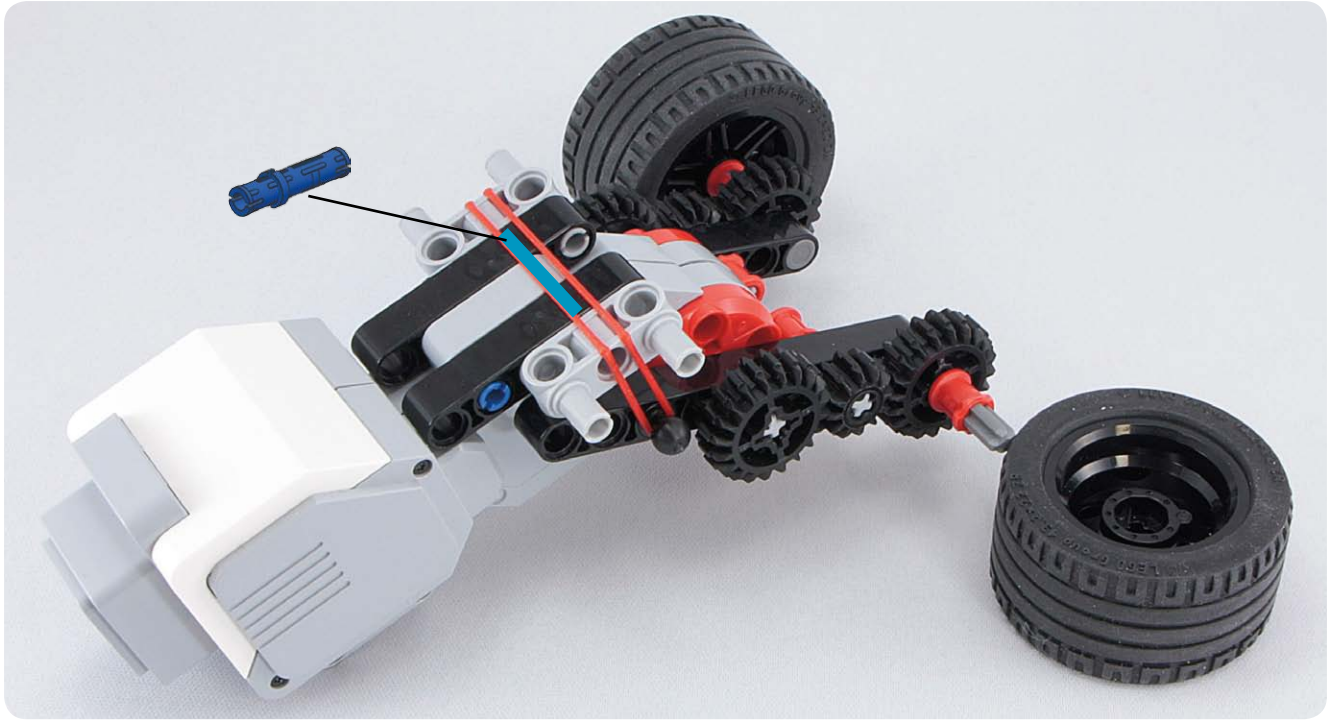

#120

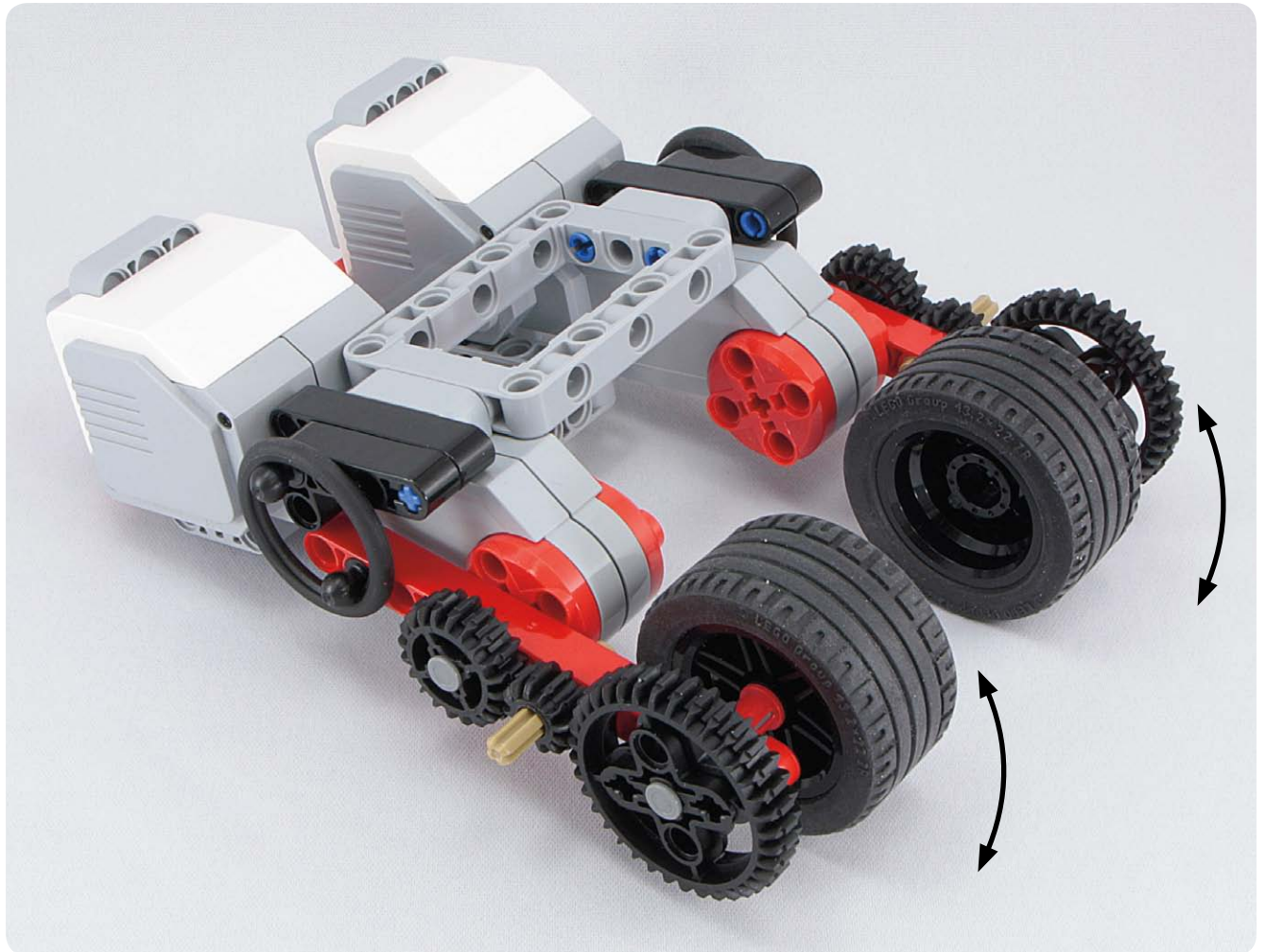

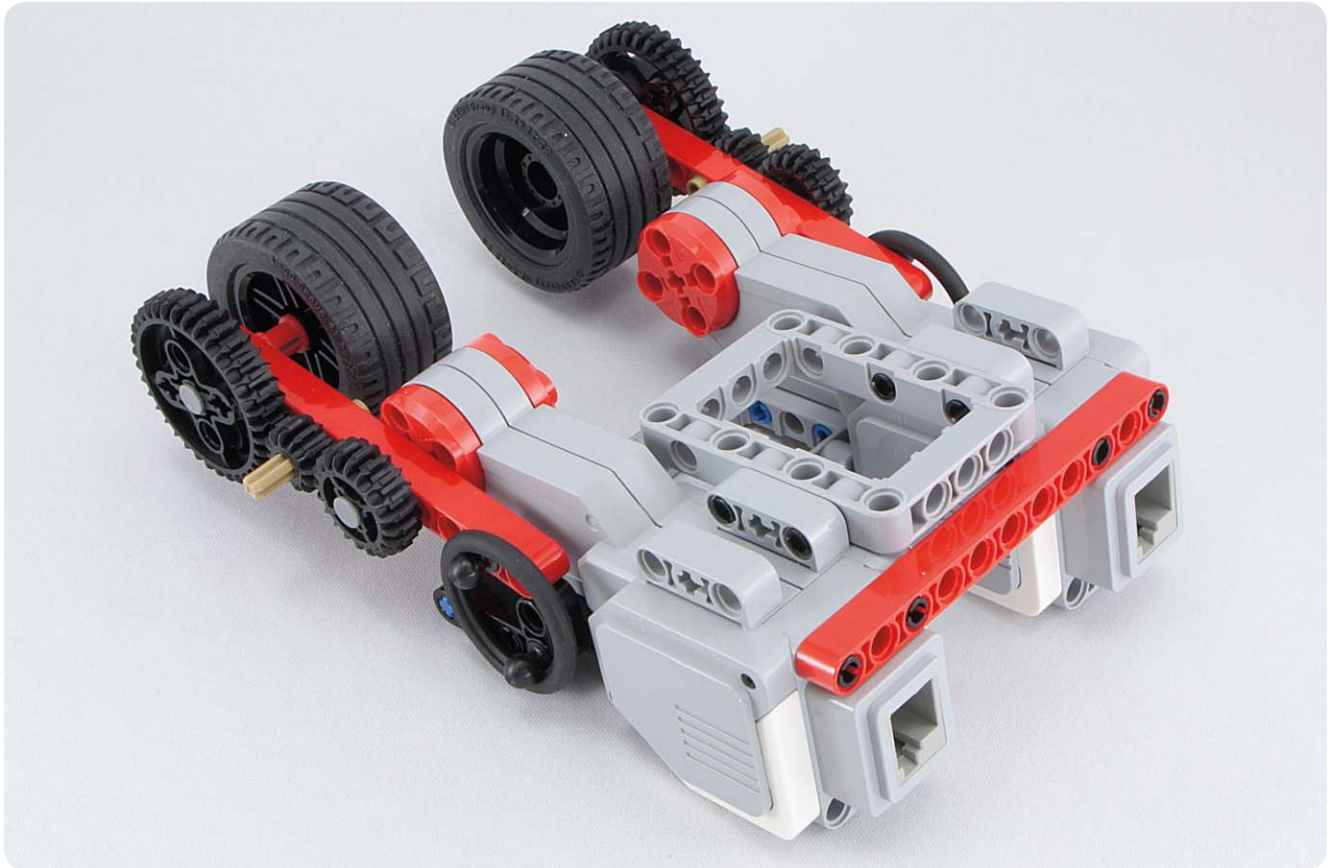
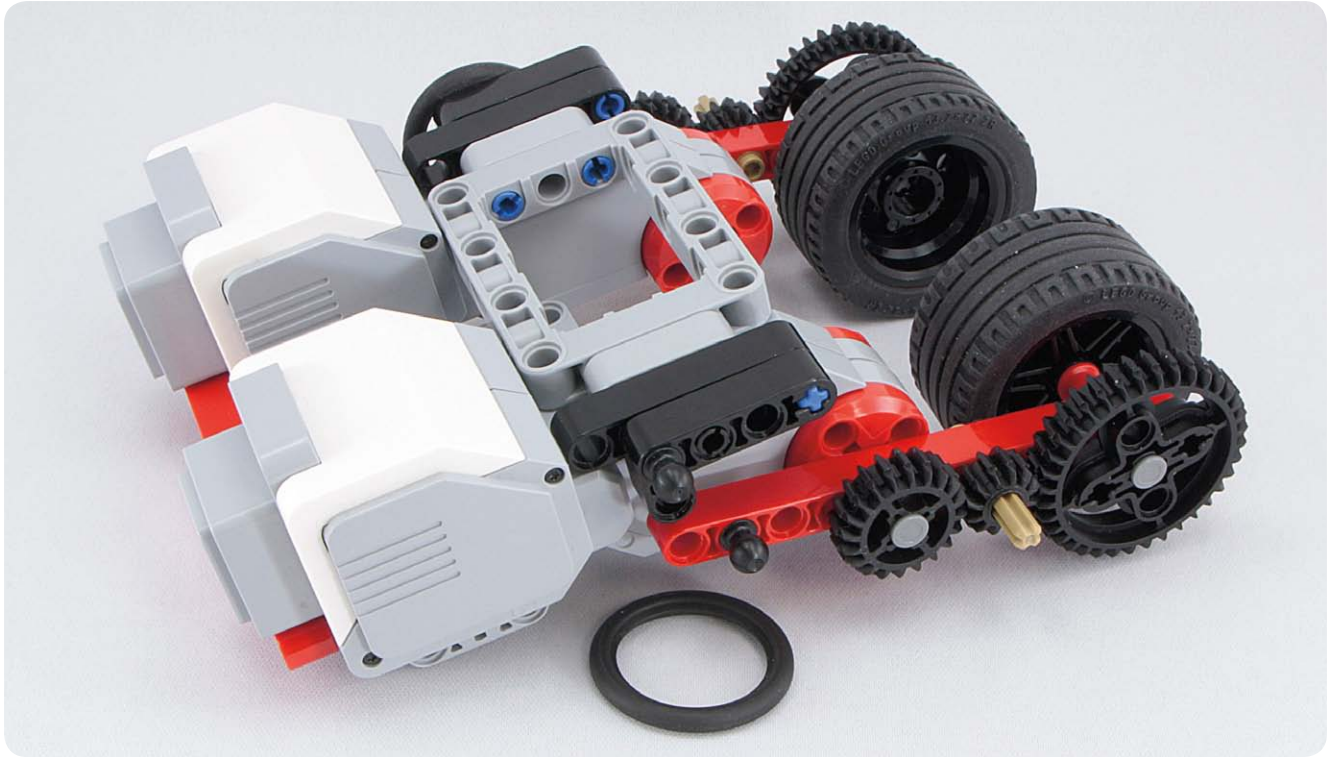

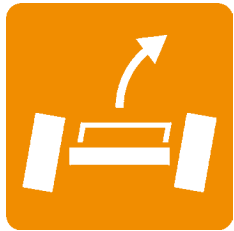

Steering

#121

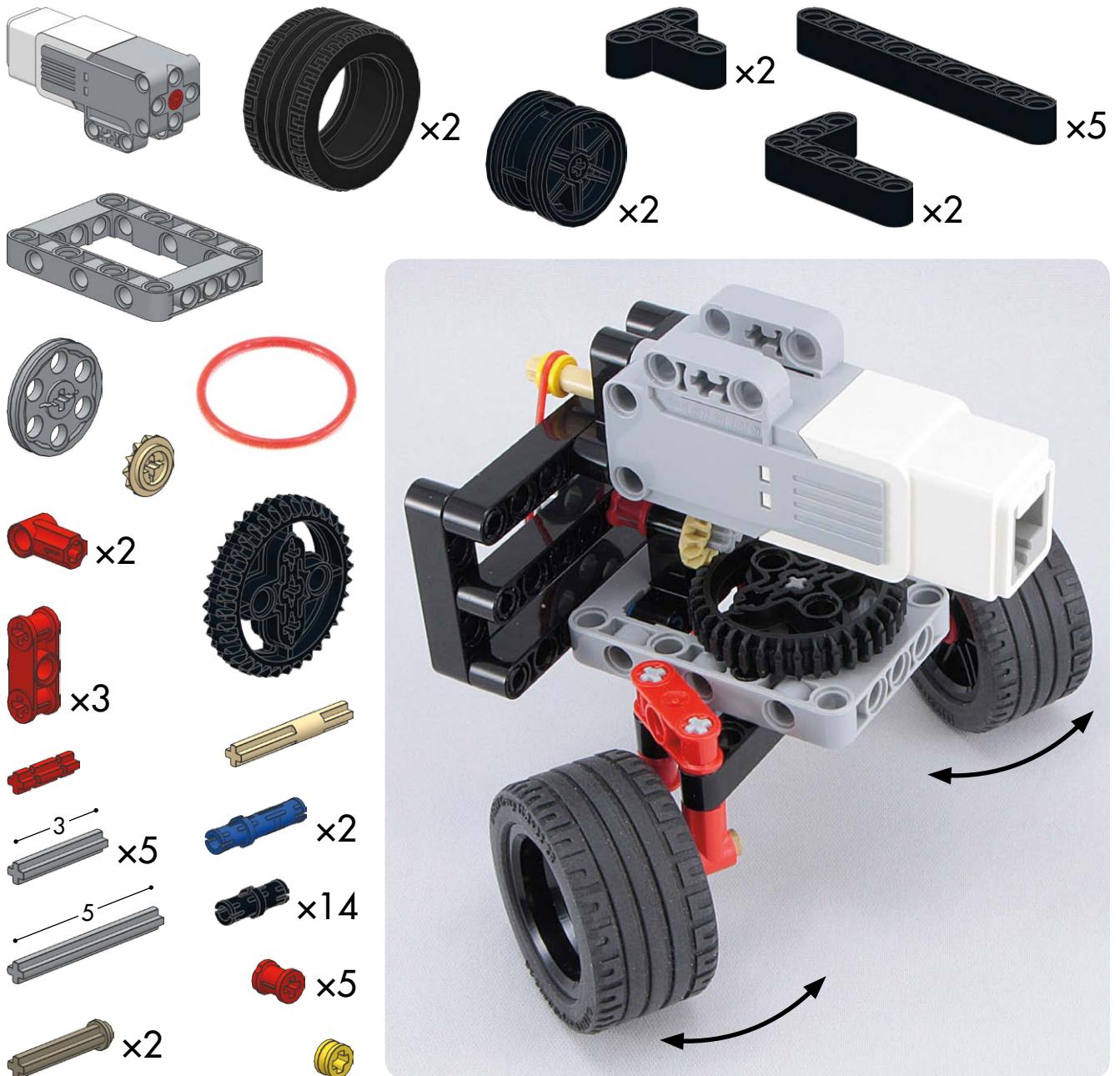

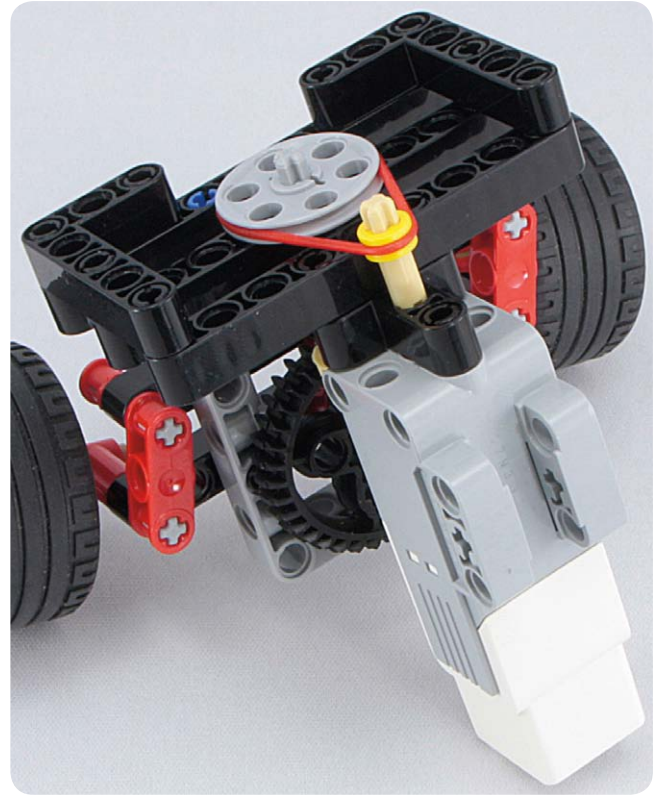
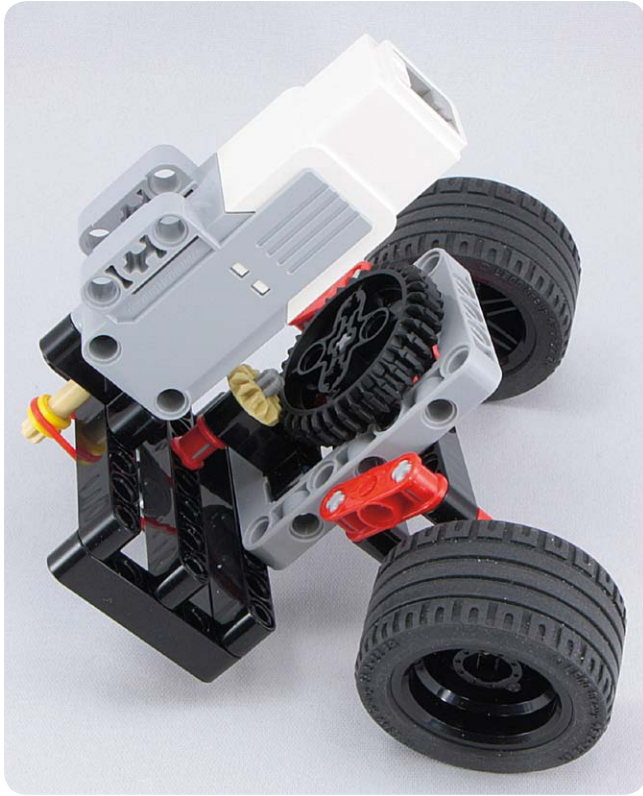

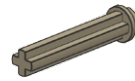
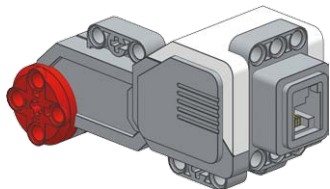
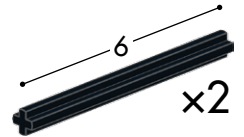
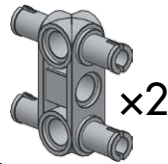
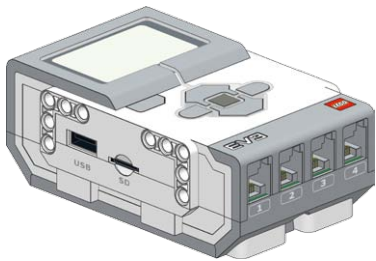

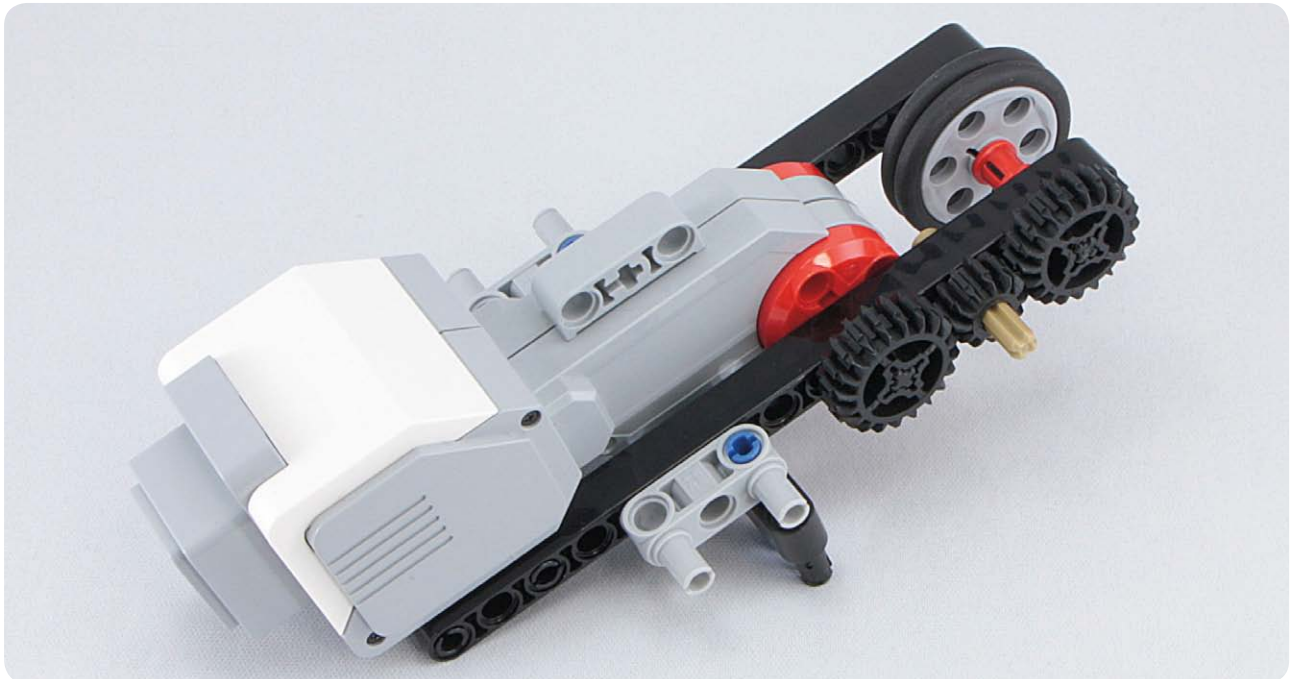
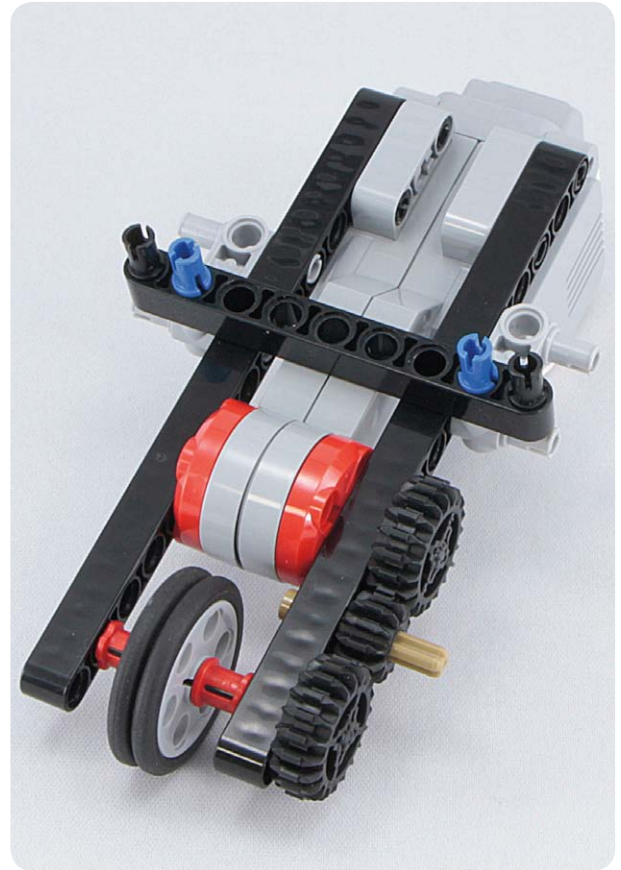

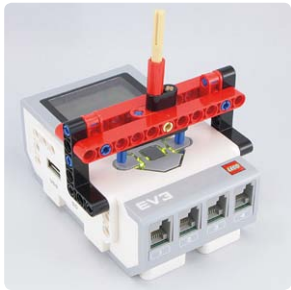

PART 3

● ● ● ○ ○ ○

Moving Without Tires



110

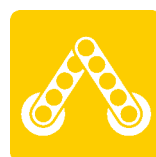

122

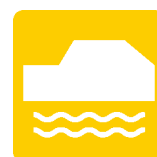

126

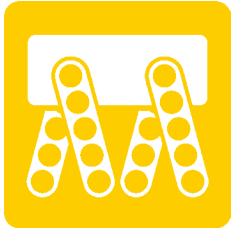

Walking machines

#122

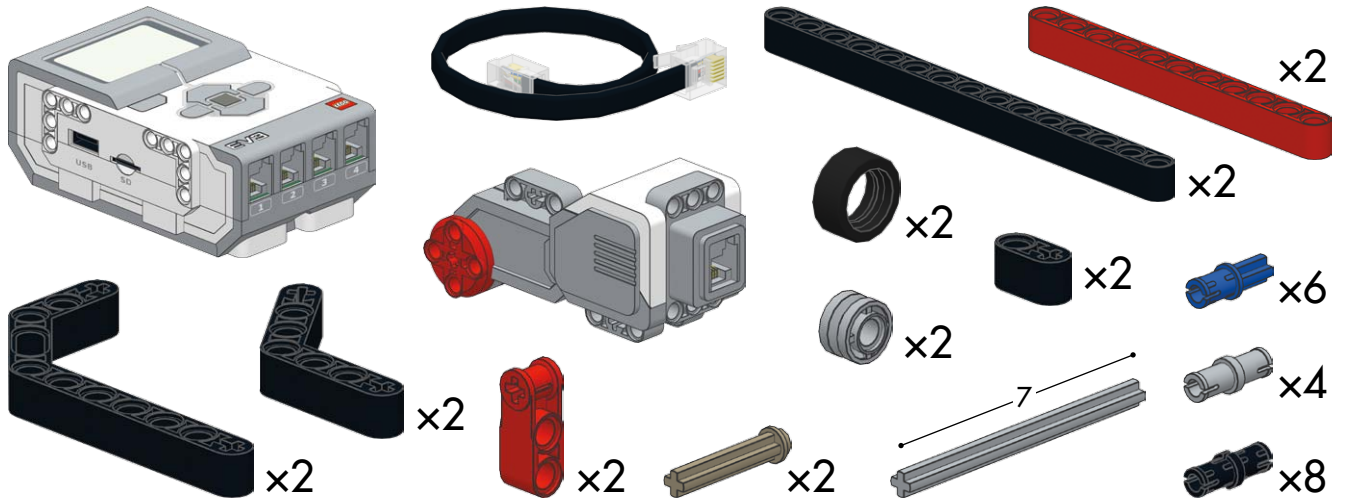

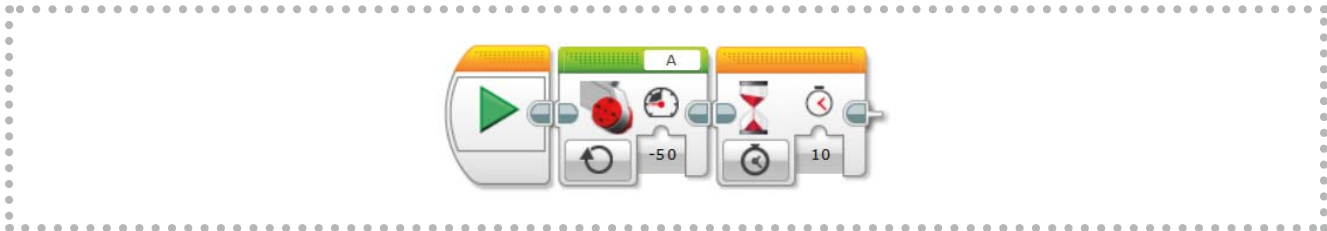

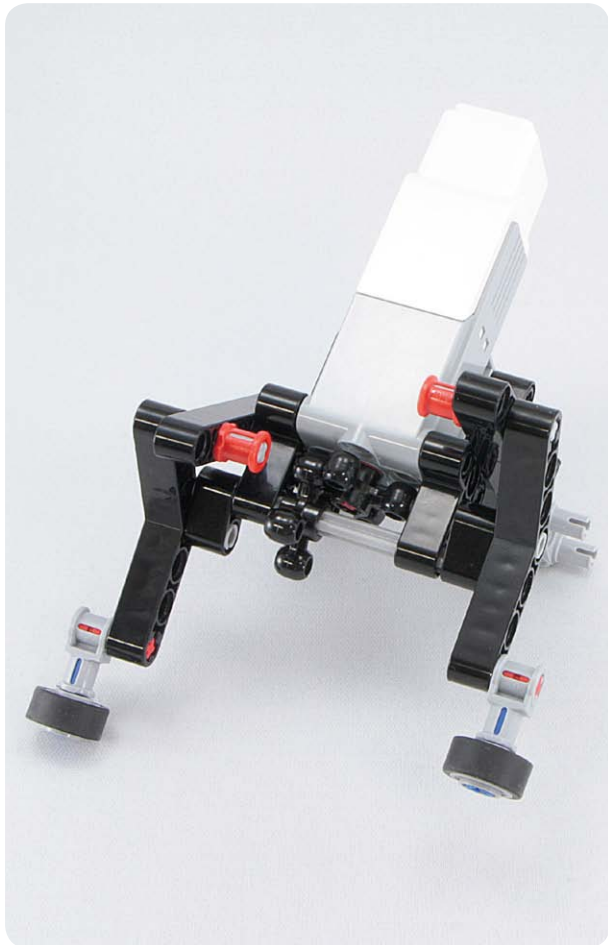

#124

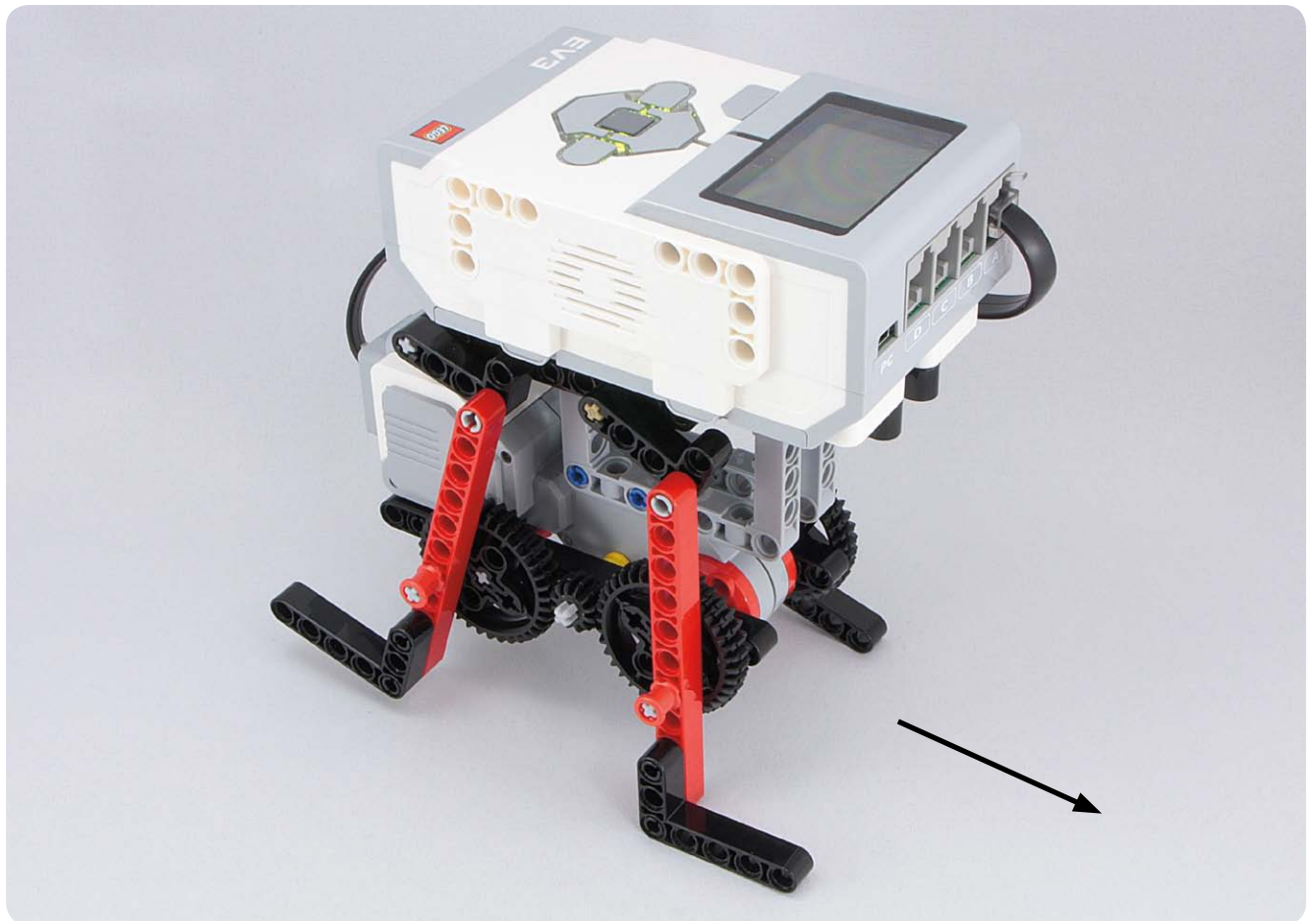
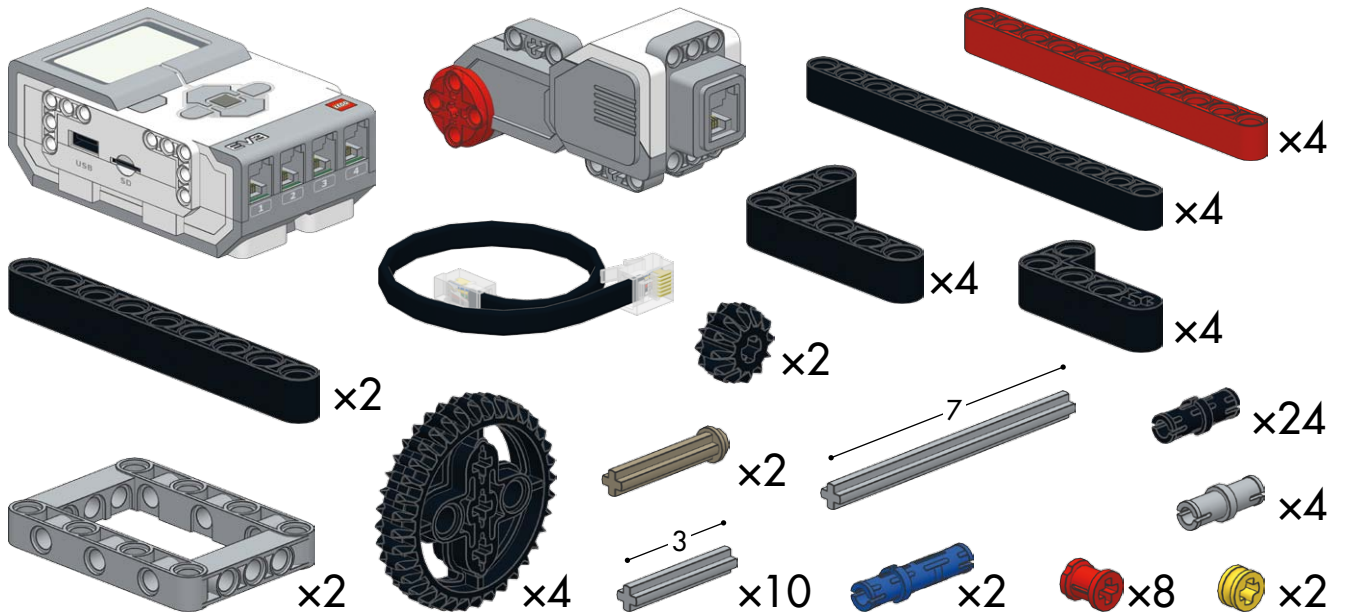

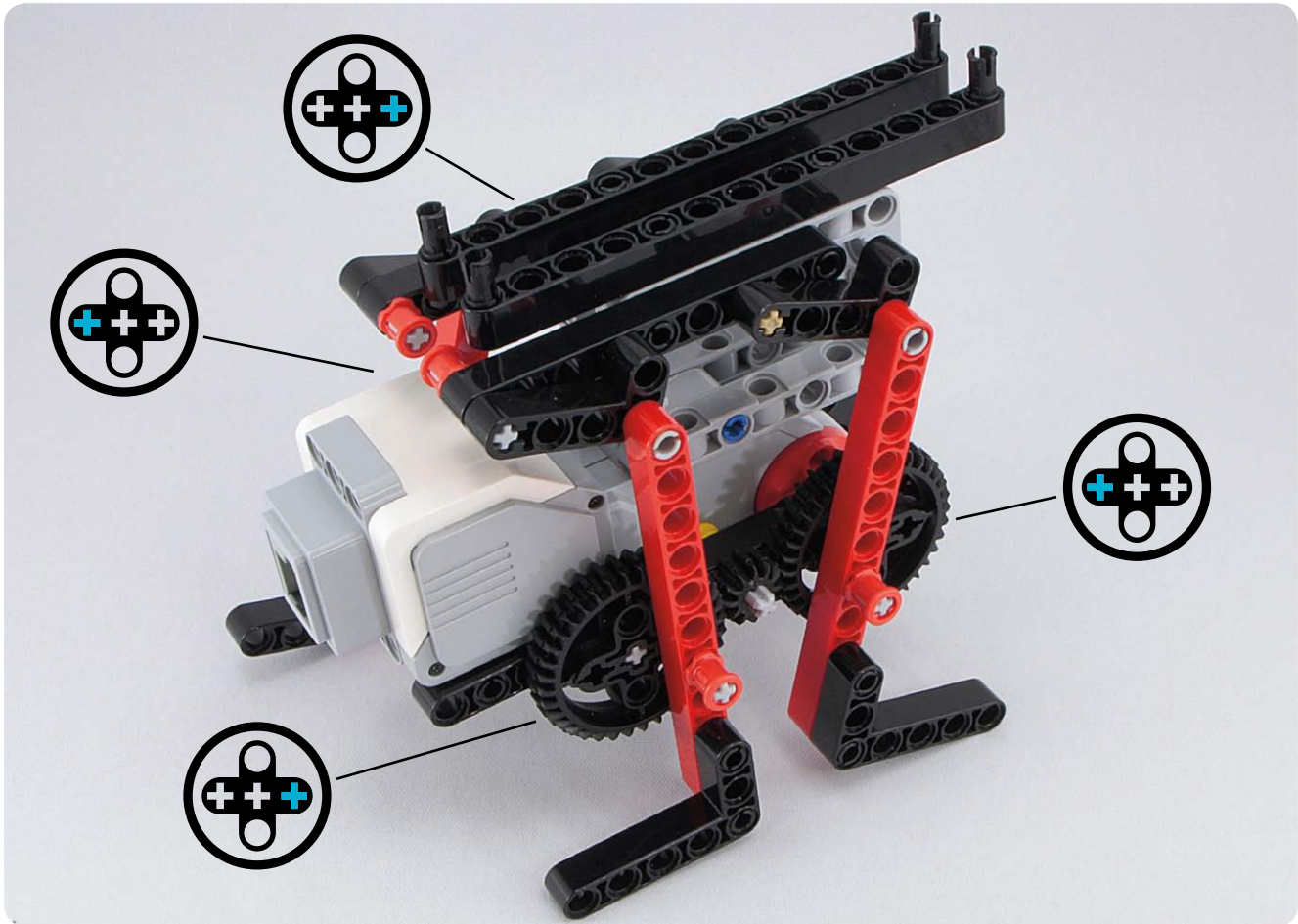
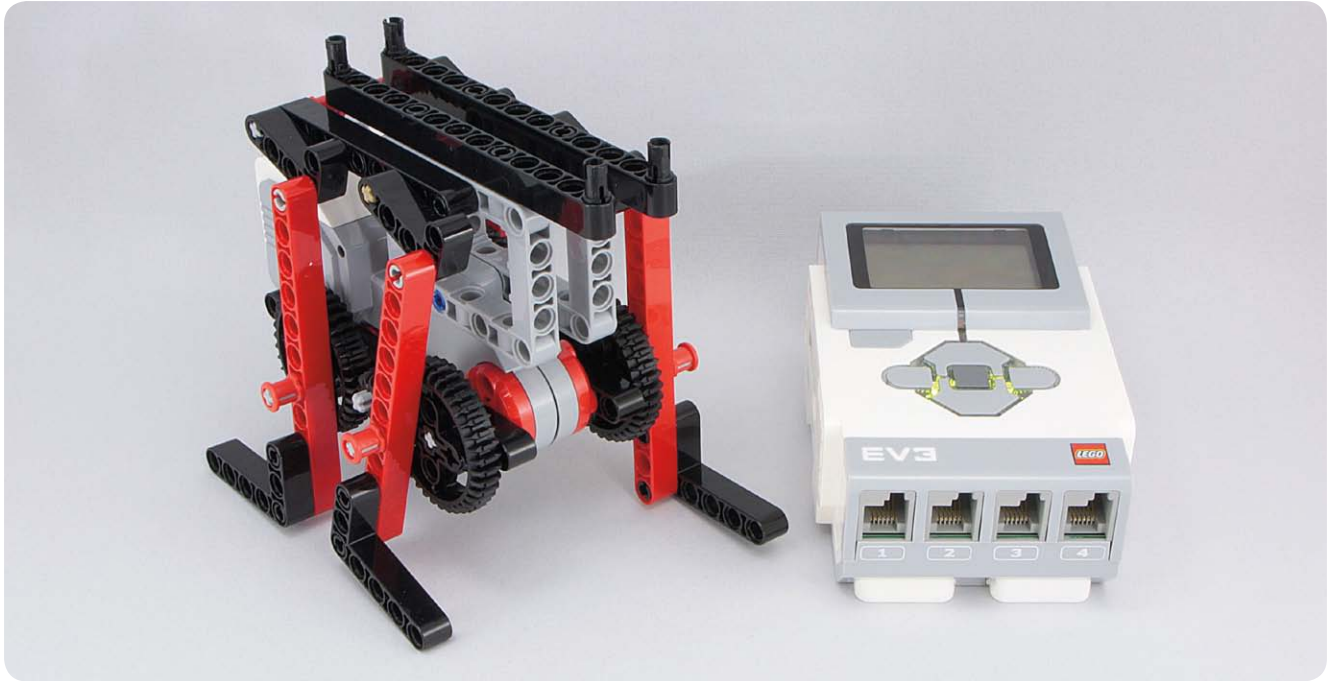

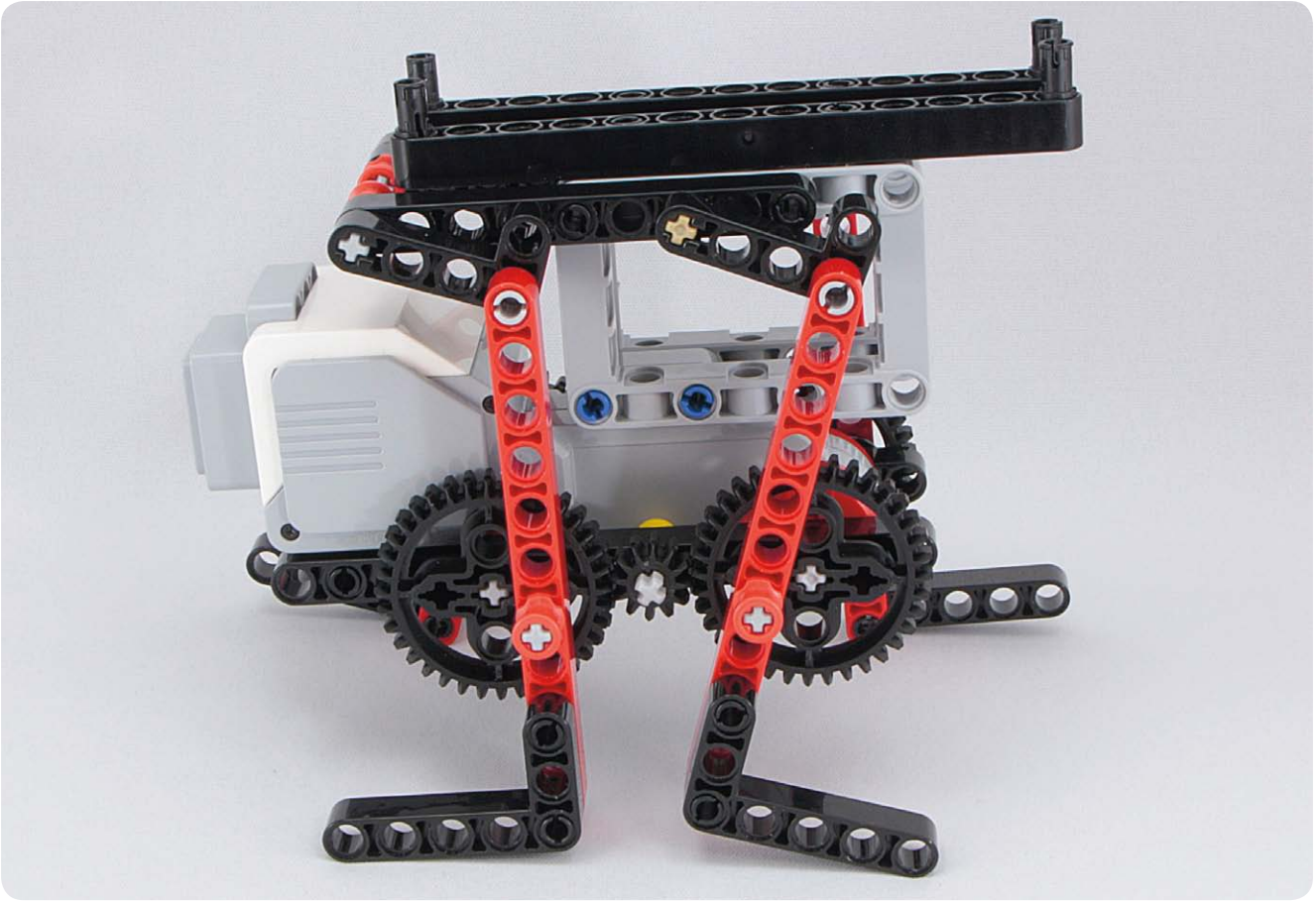

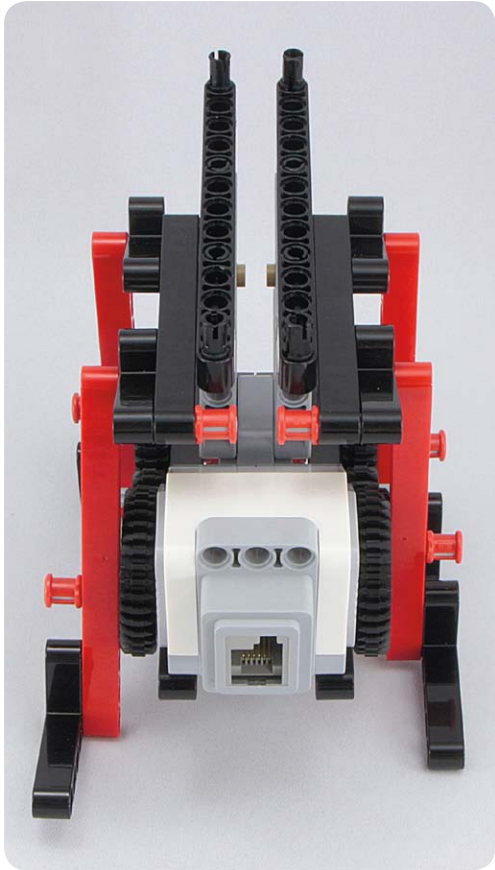

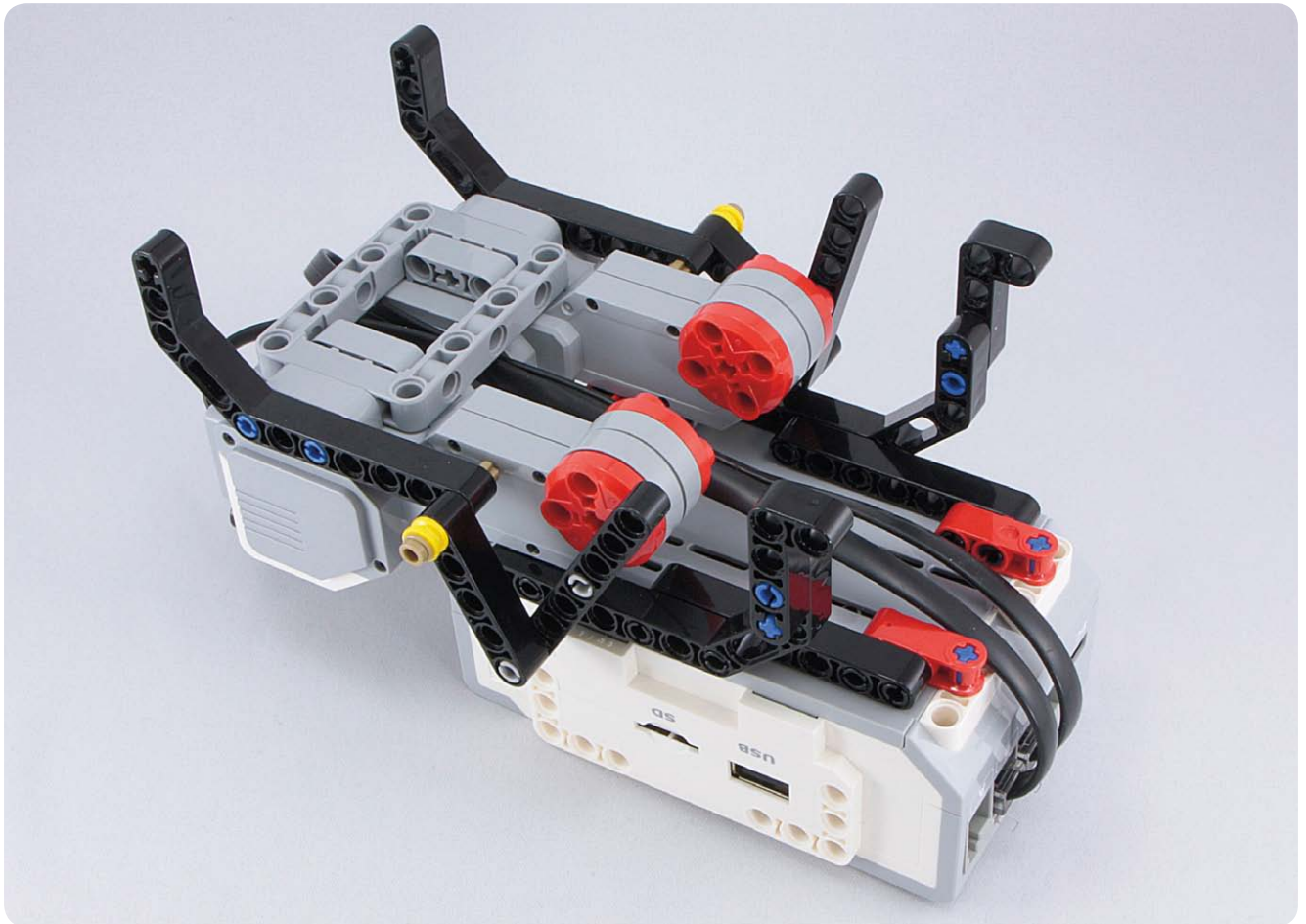
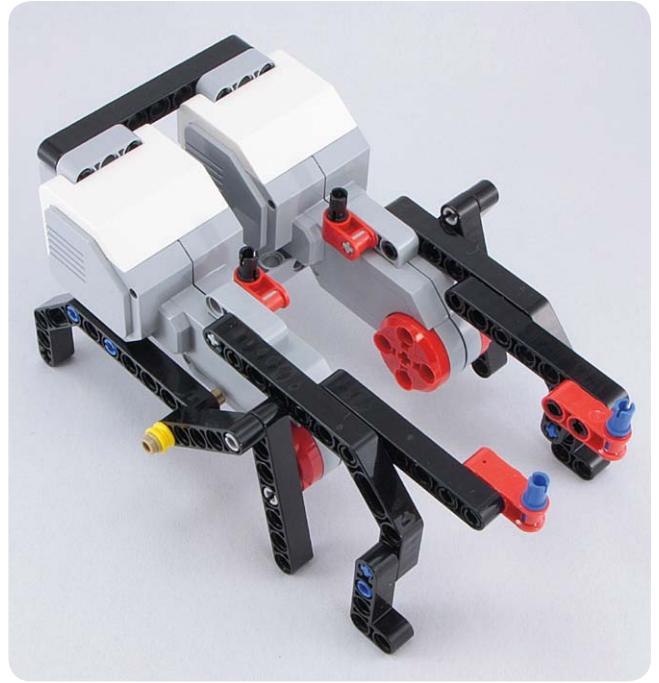

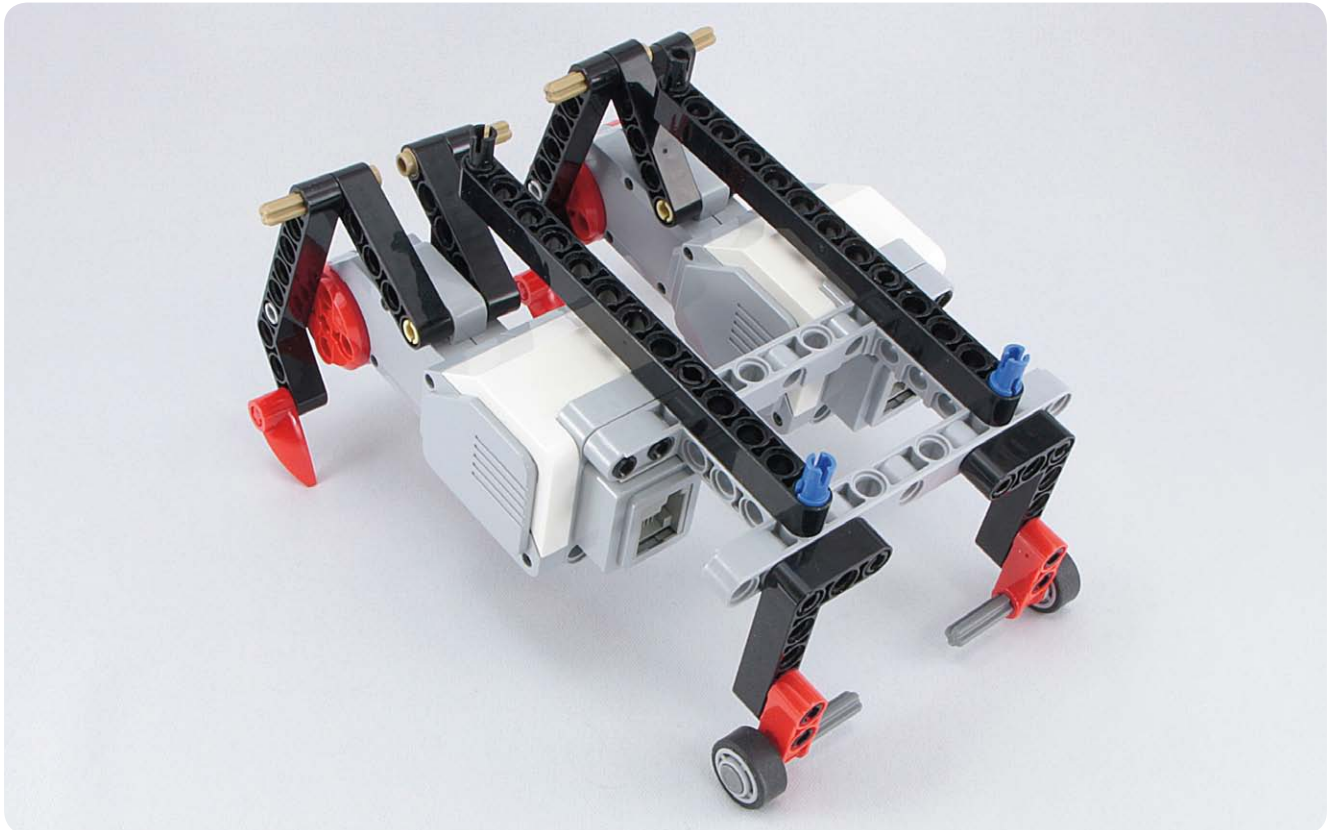
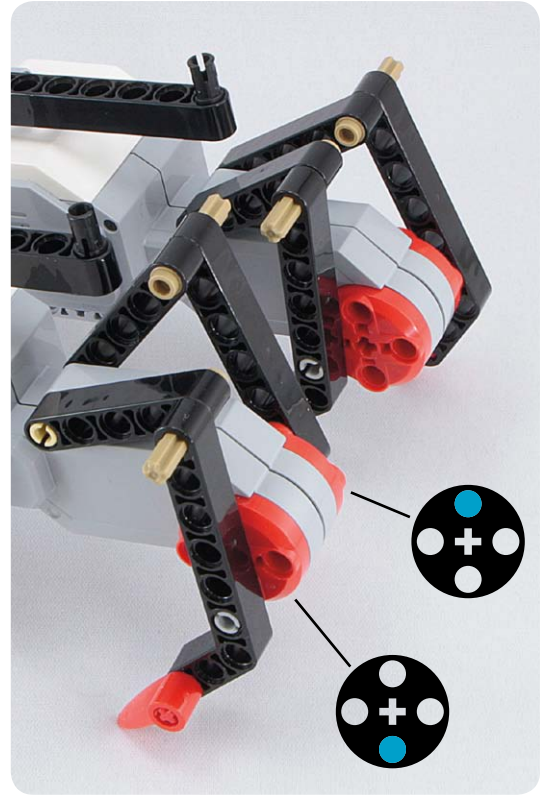
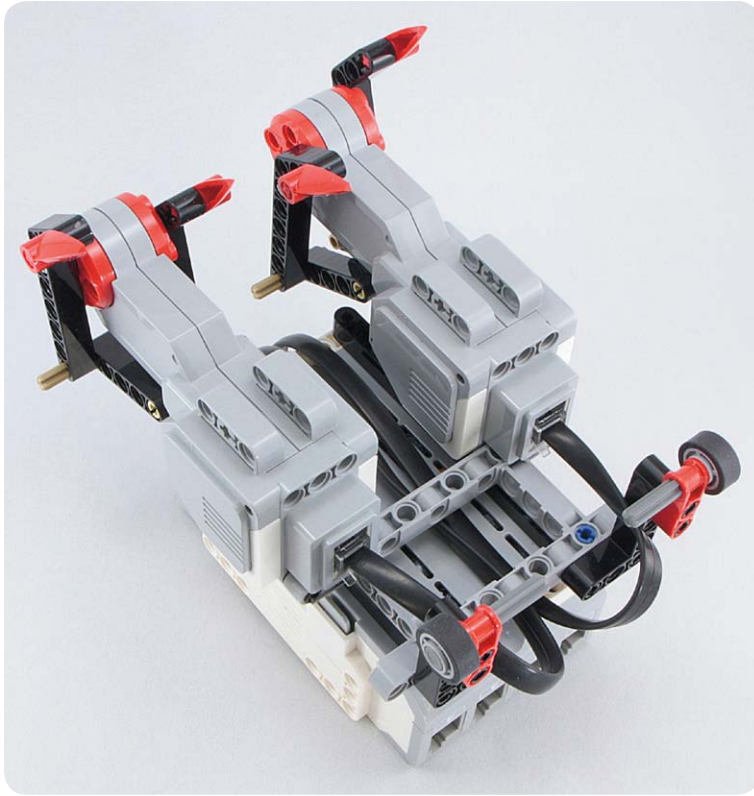

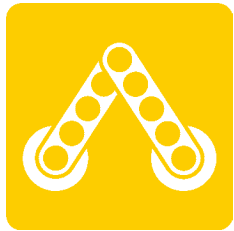

Moving like an inchworm

#127

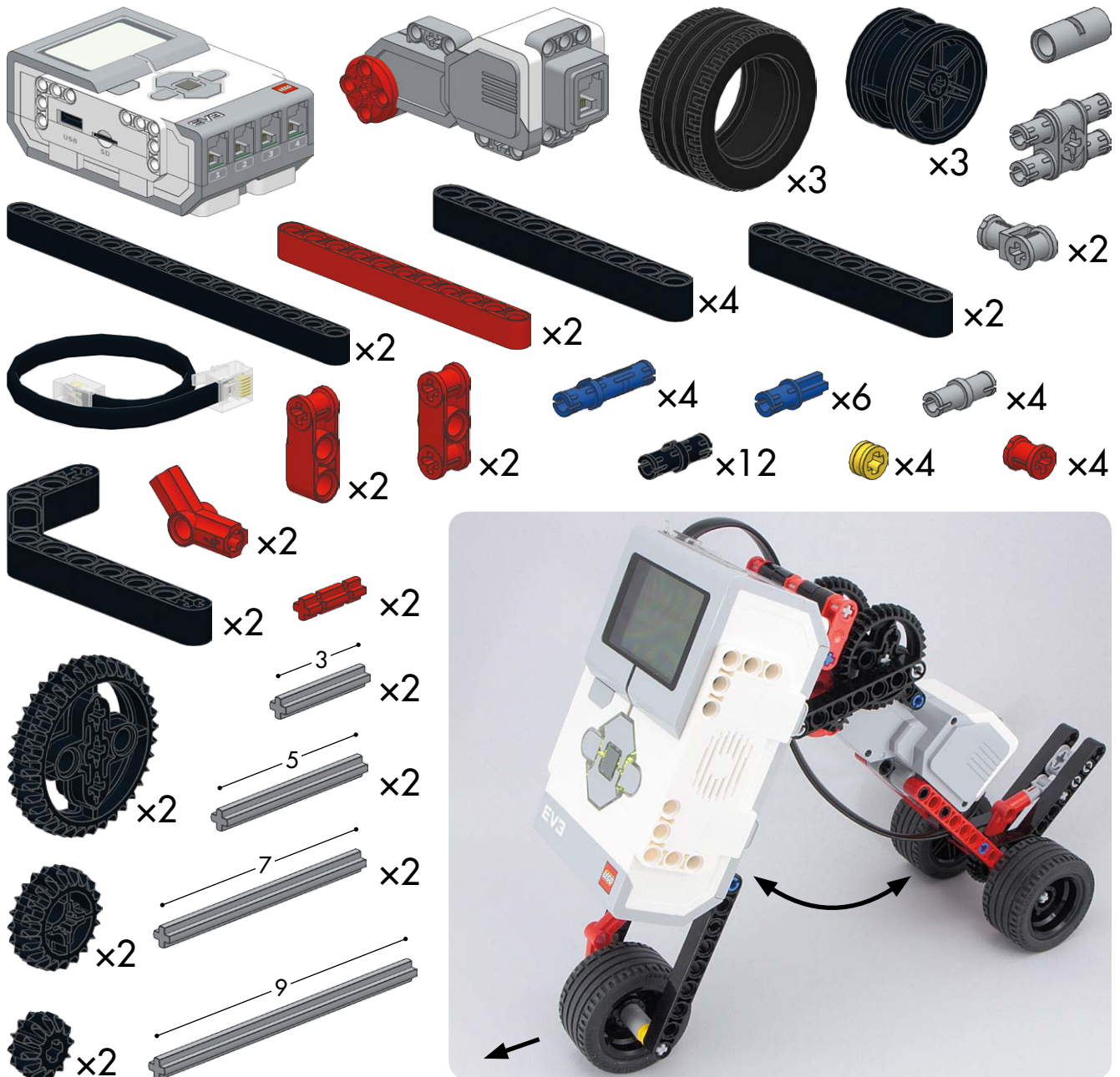



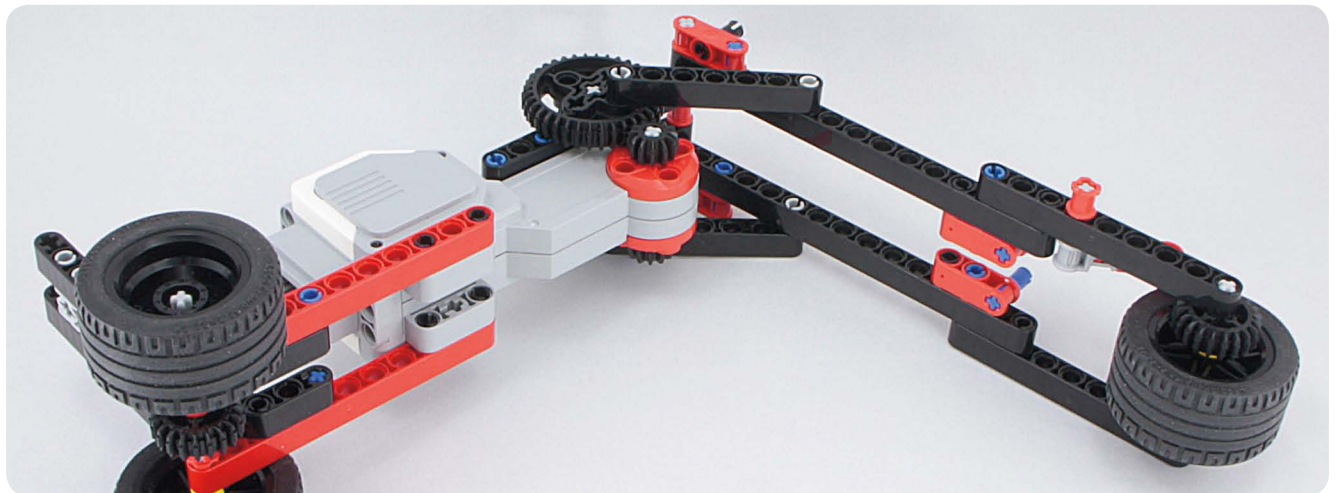
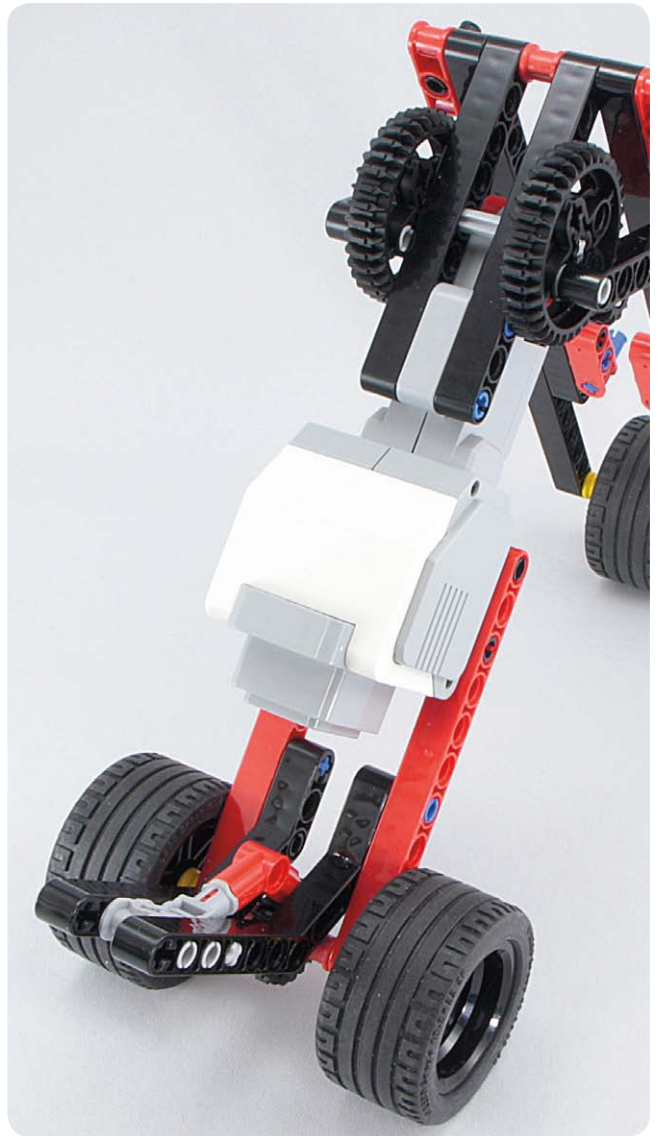

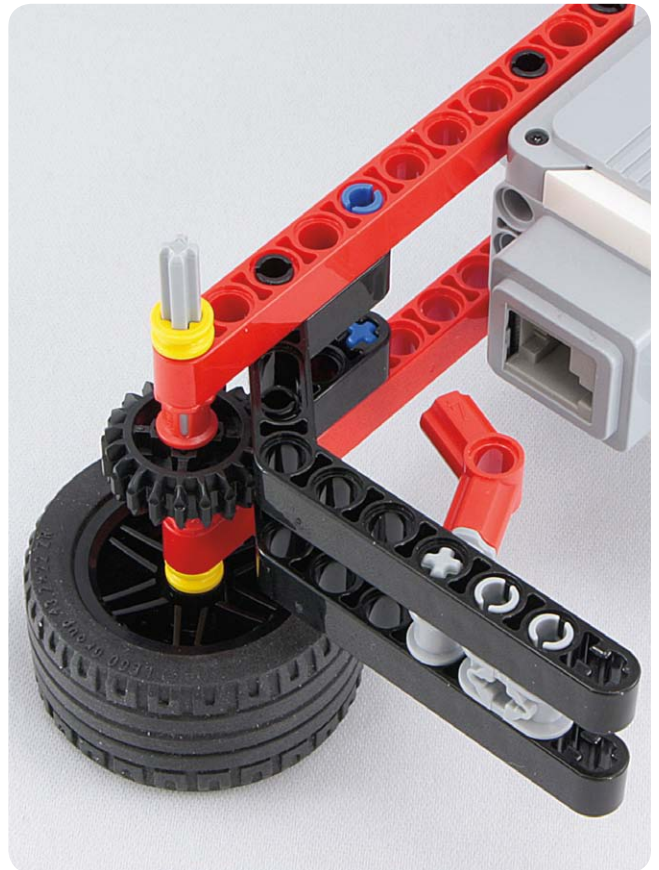

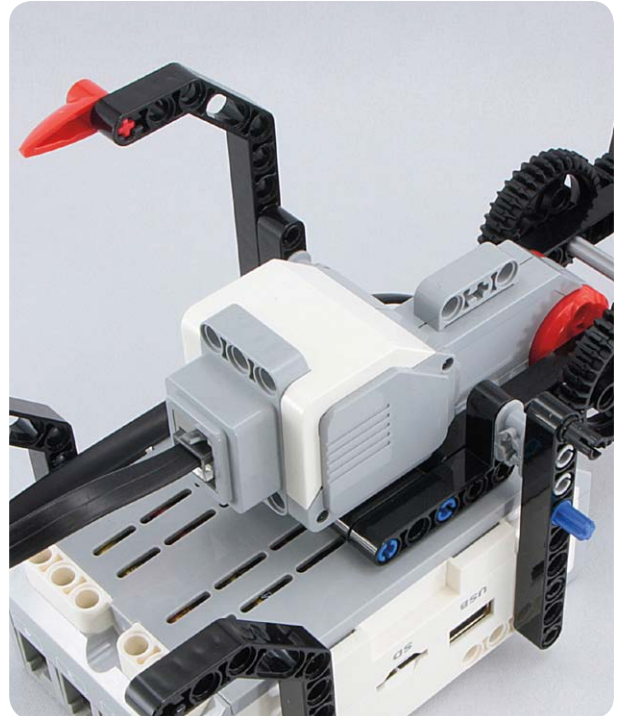



PART 4

● ● ● ● ○ ○

Arms, Wings, and Other Movements



130



158



180



194



140



168



184



198

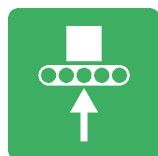

152

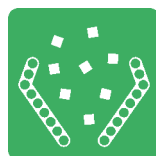

176



188

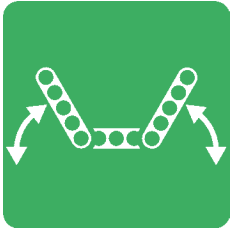

Flapping wings

#129

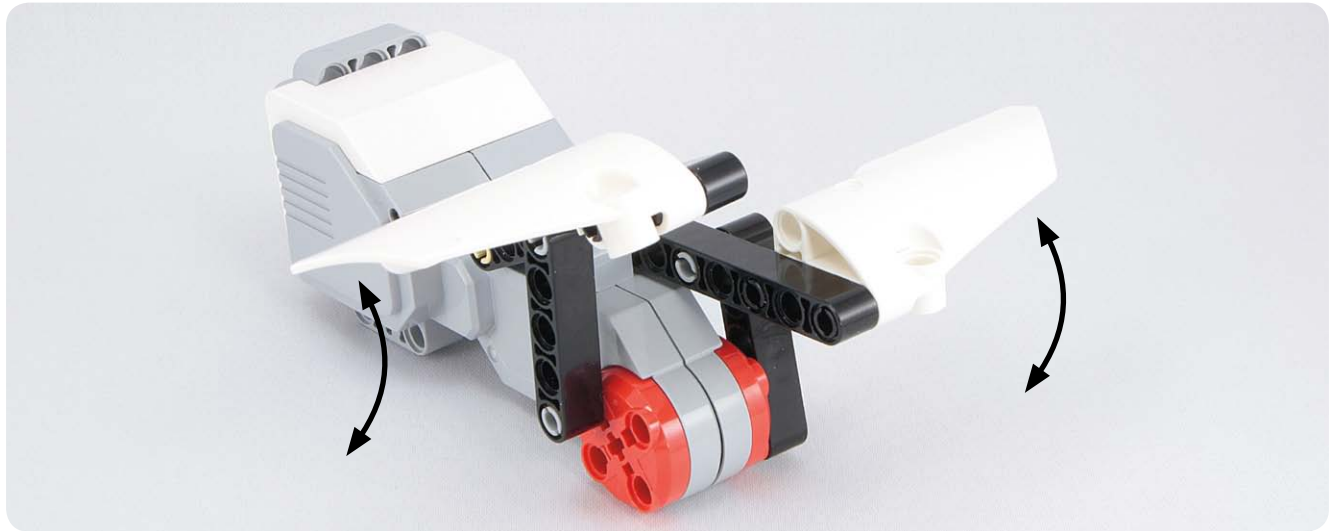
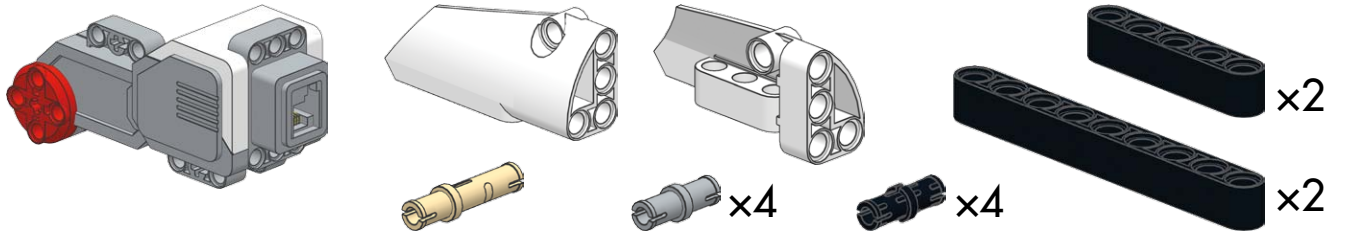

#130

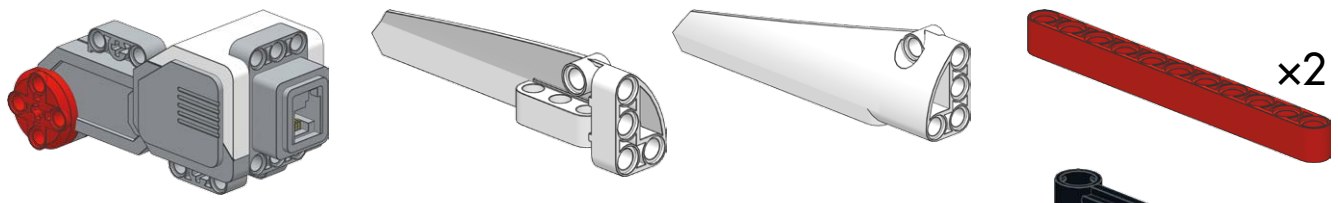

- Red Technic beam x2
- Black Technic axle with bush x2
- Red Technic axle with bush x2
- Red Technic axle with bush x2
- Red Technic axle with bush x2
- Red Technic axle with bush x2
- Grey Technic axle with bush x2
- Black Technic axle with bush x4
- Black Technic axle with bush x4
- Grey Technic axle with bush x2



#131

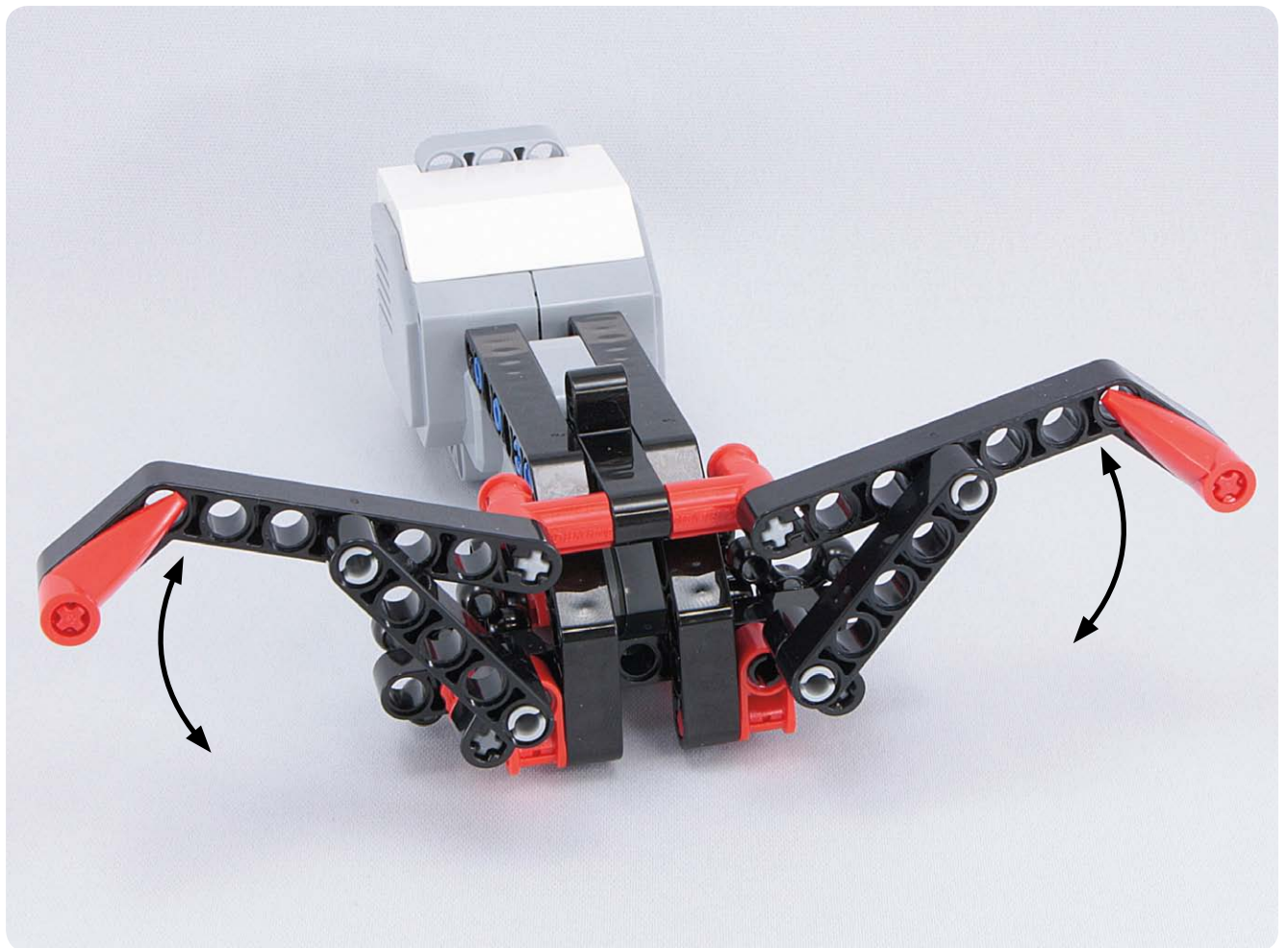
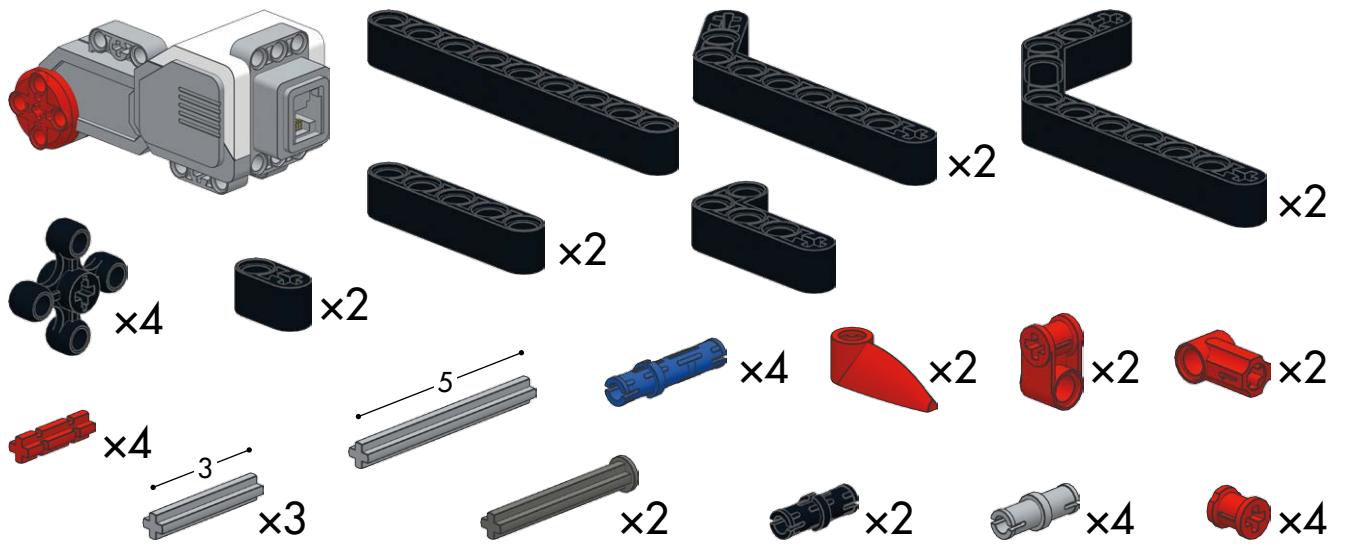



#132

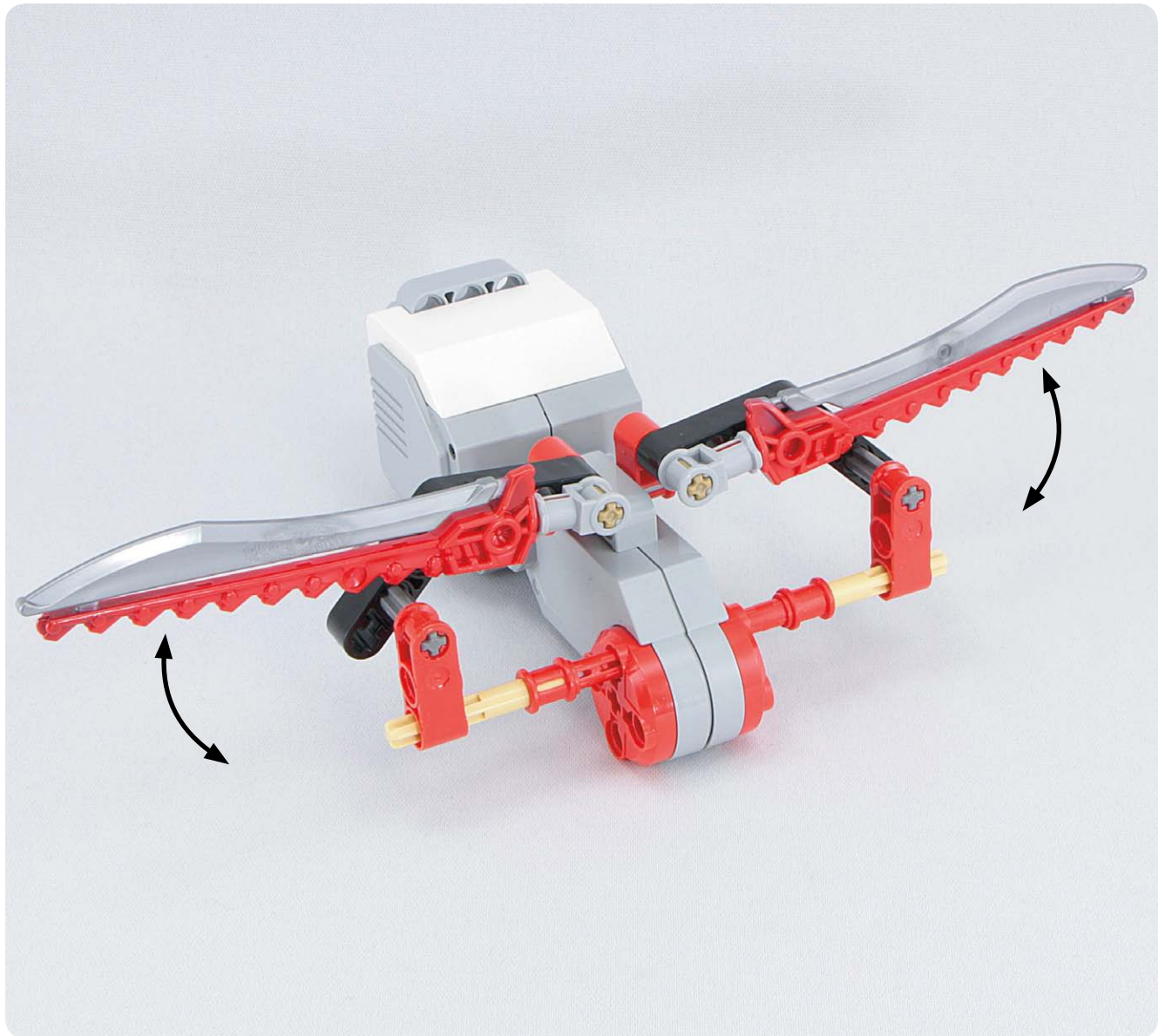
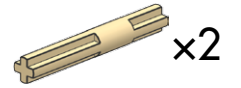
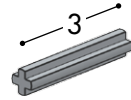
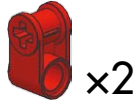
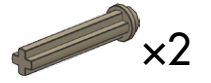
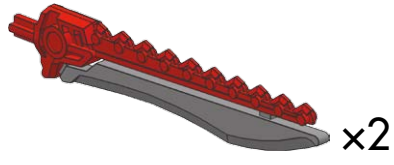
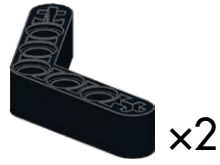
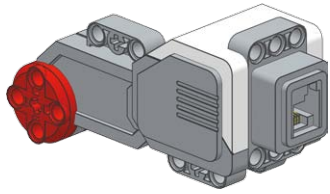

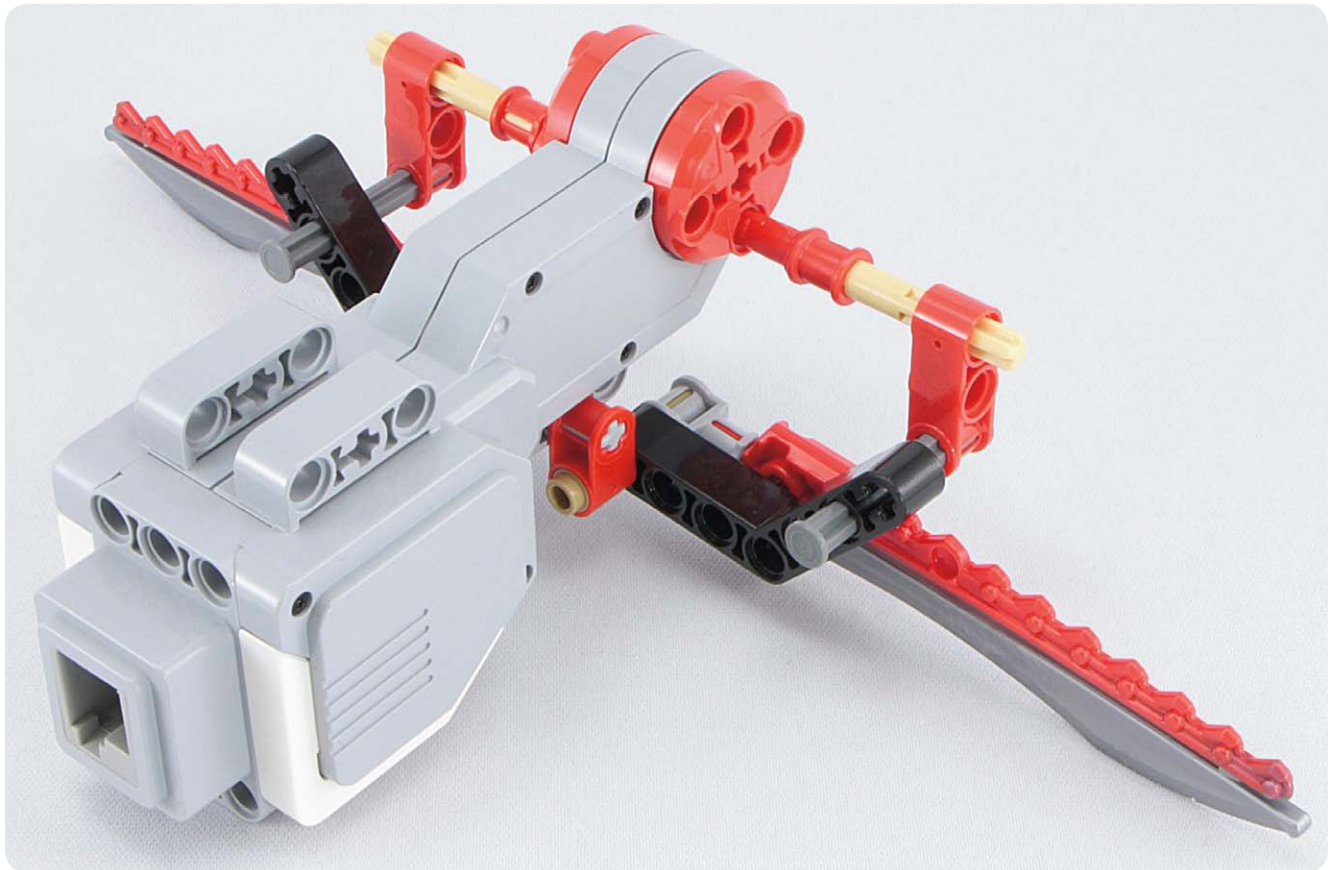

#133

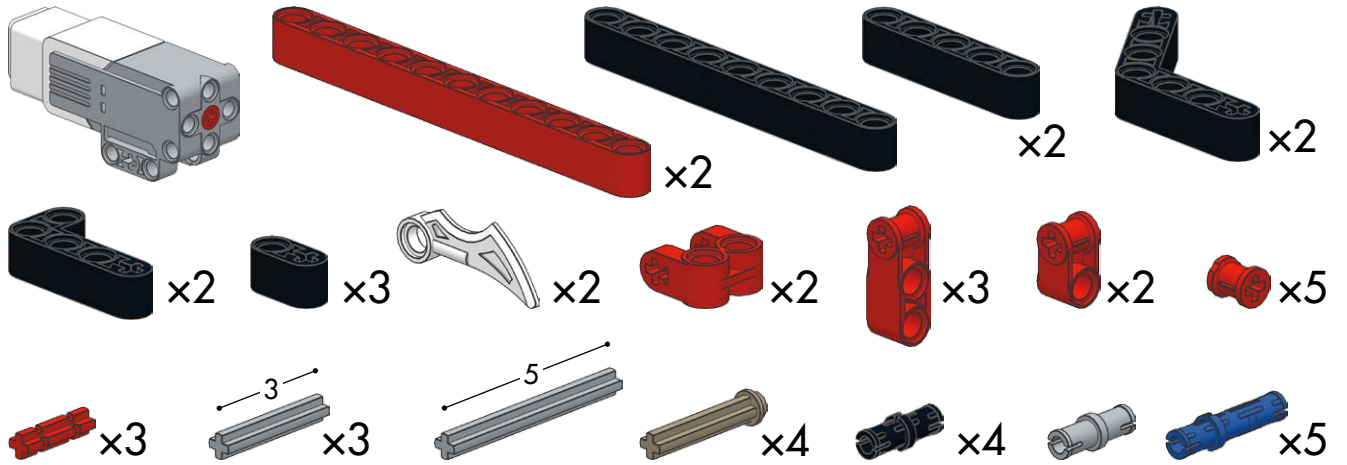

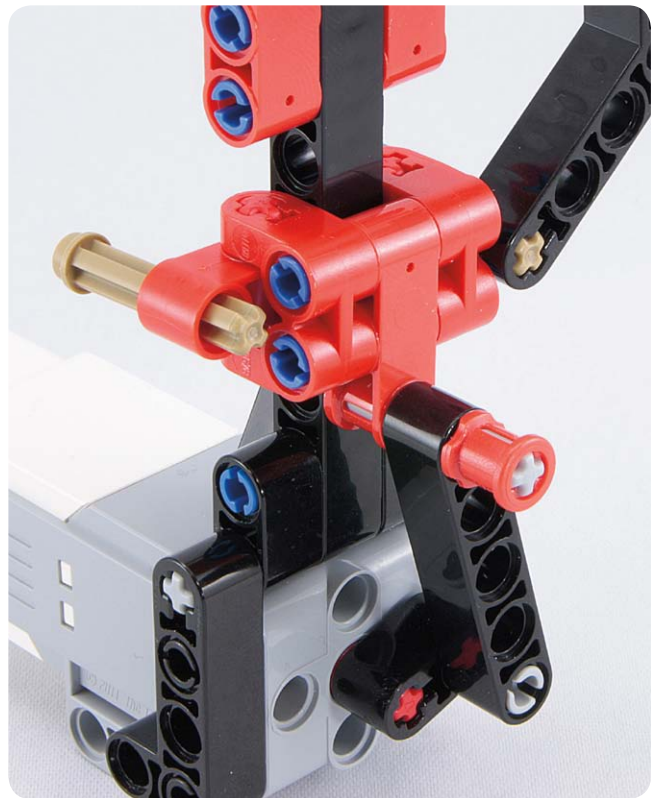
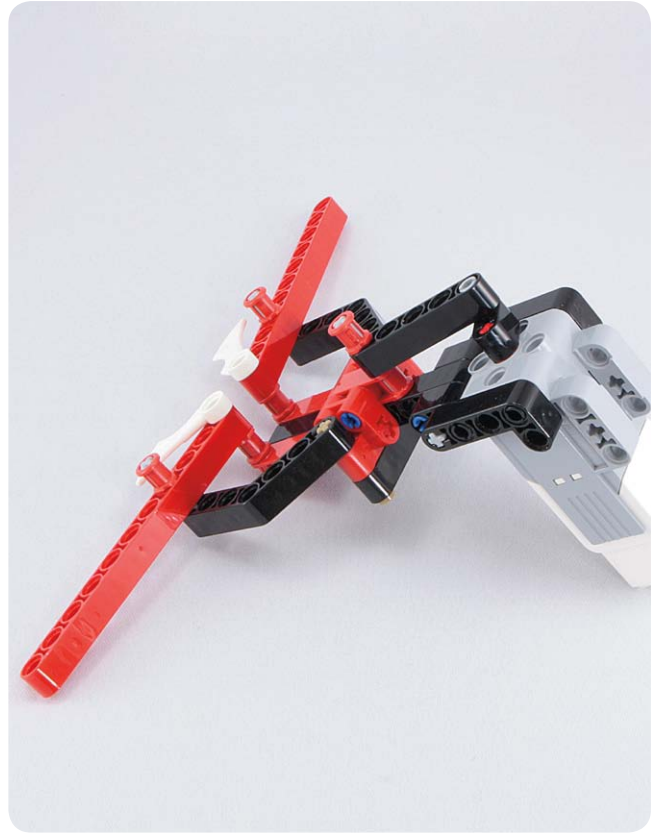

#134

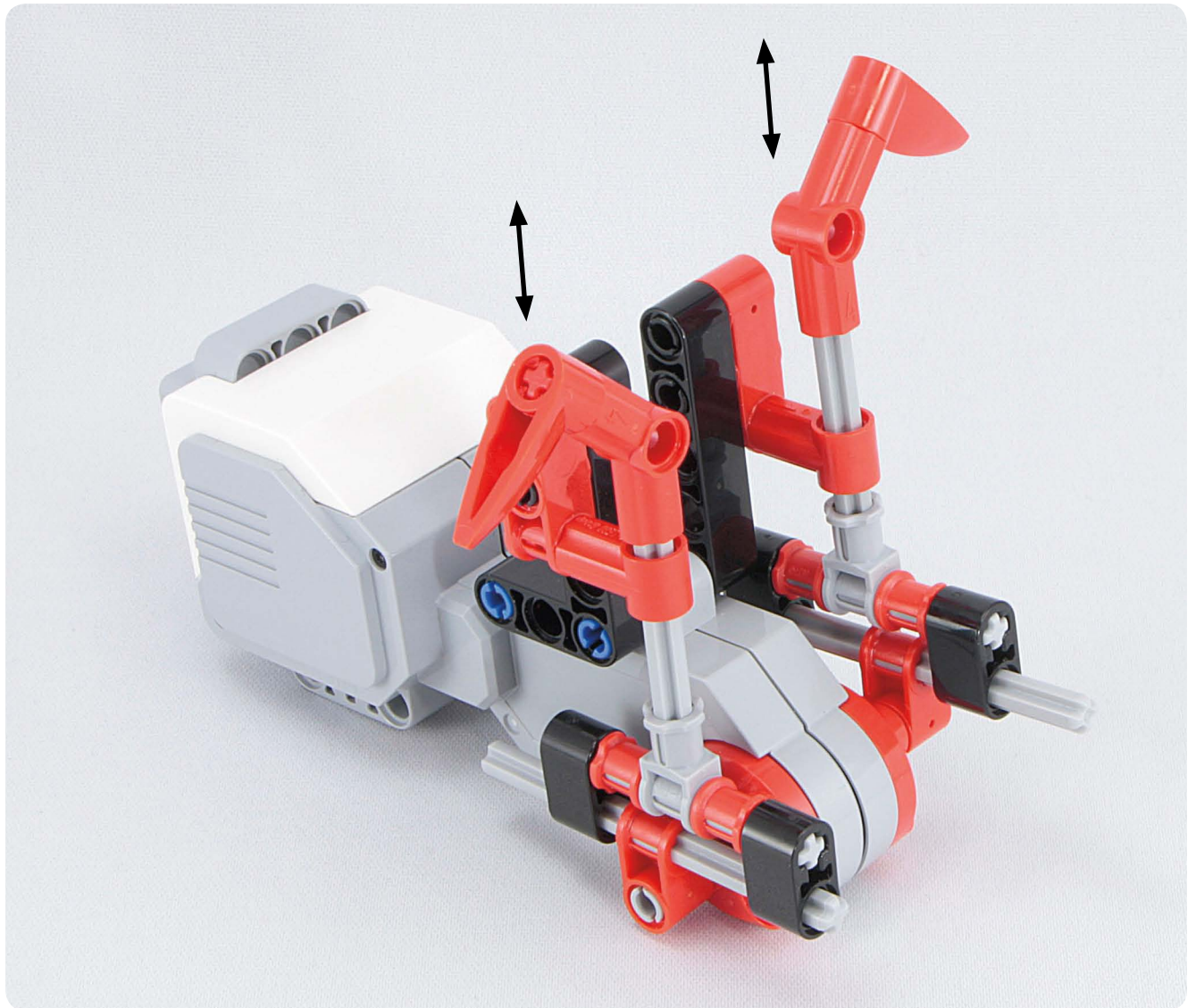
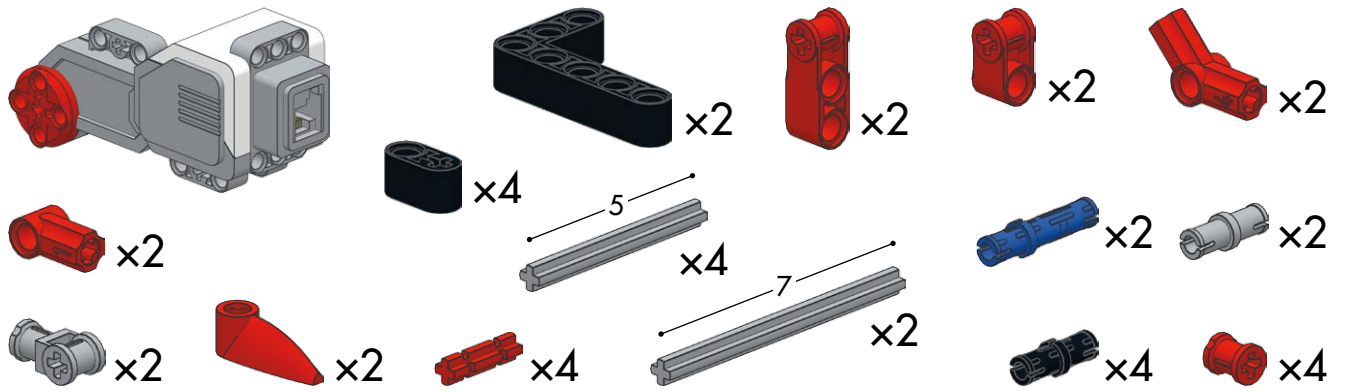

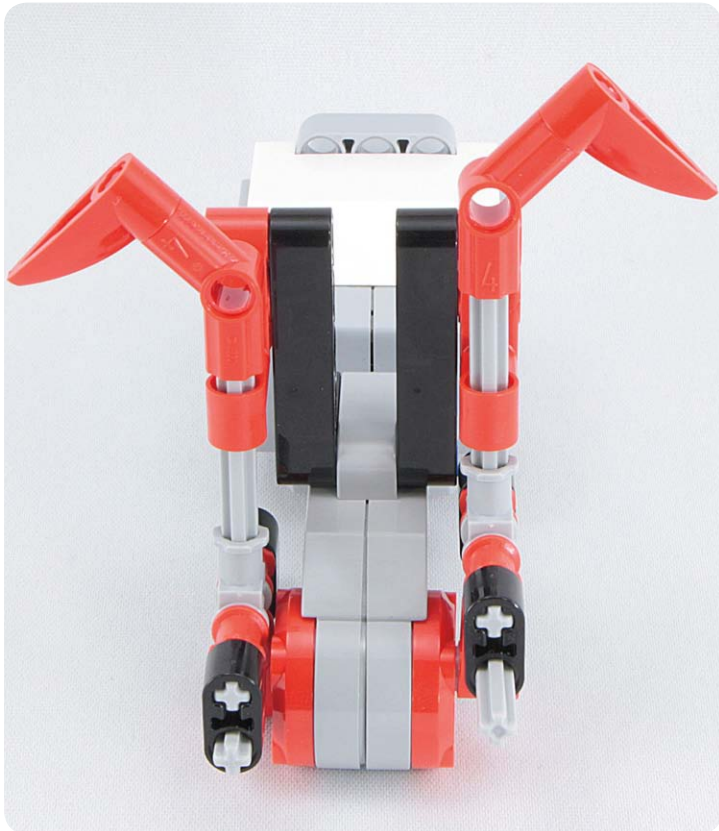
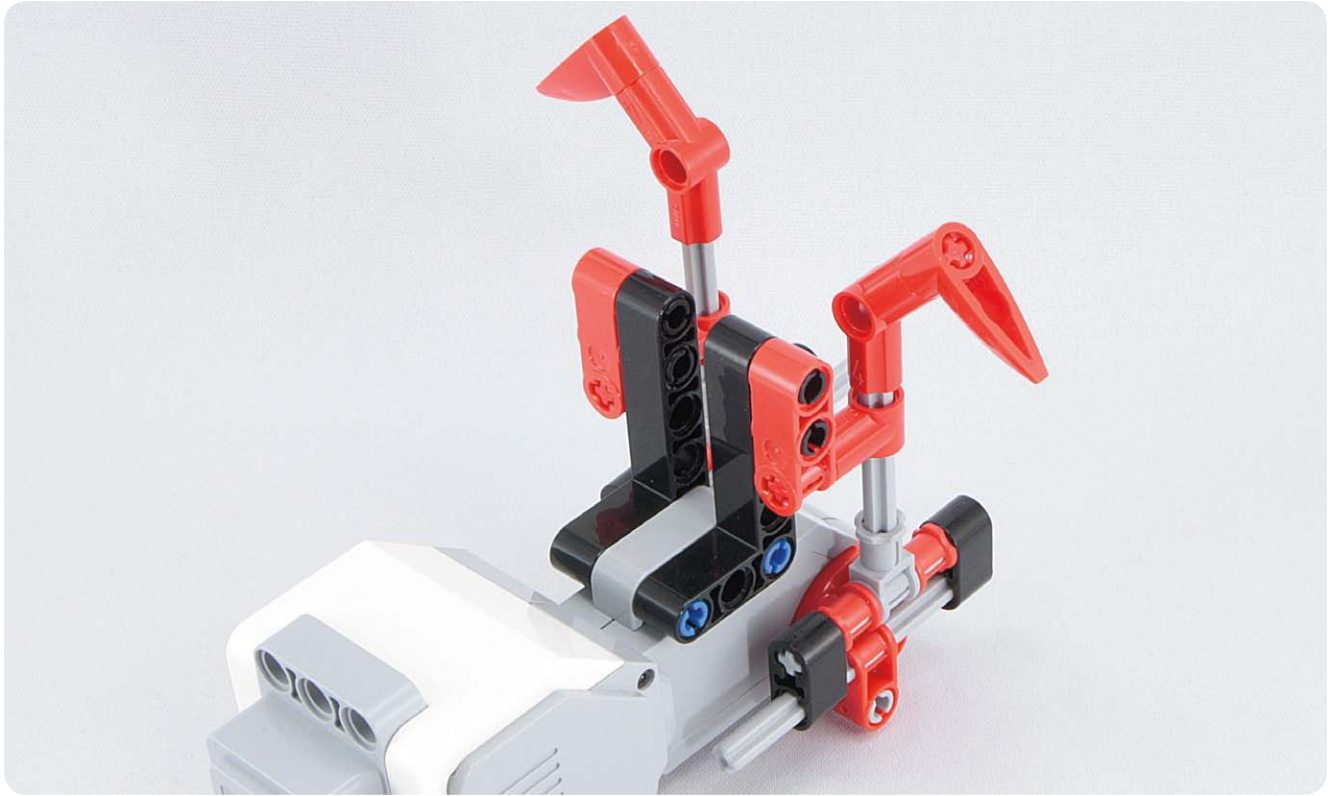

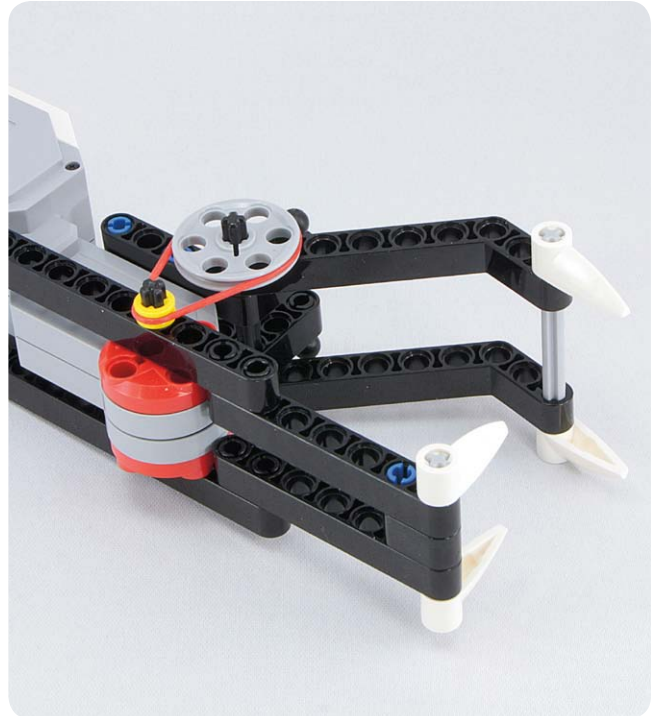
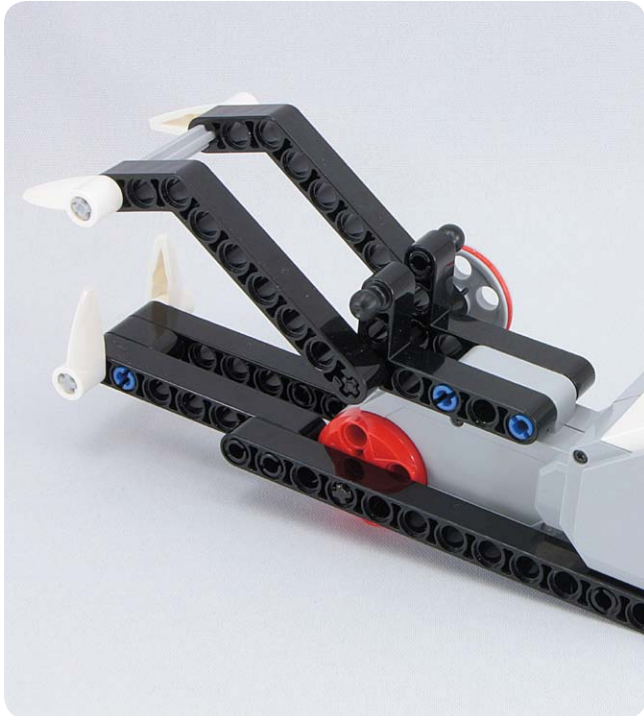
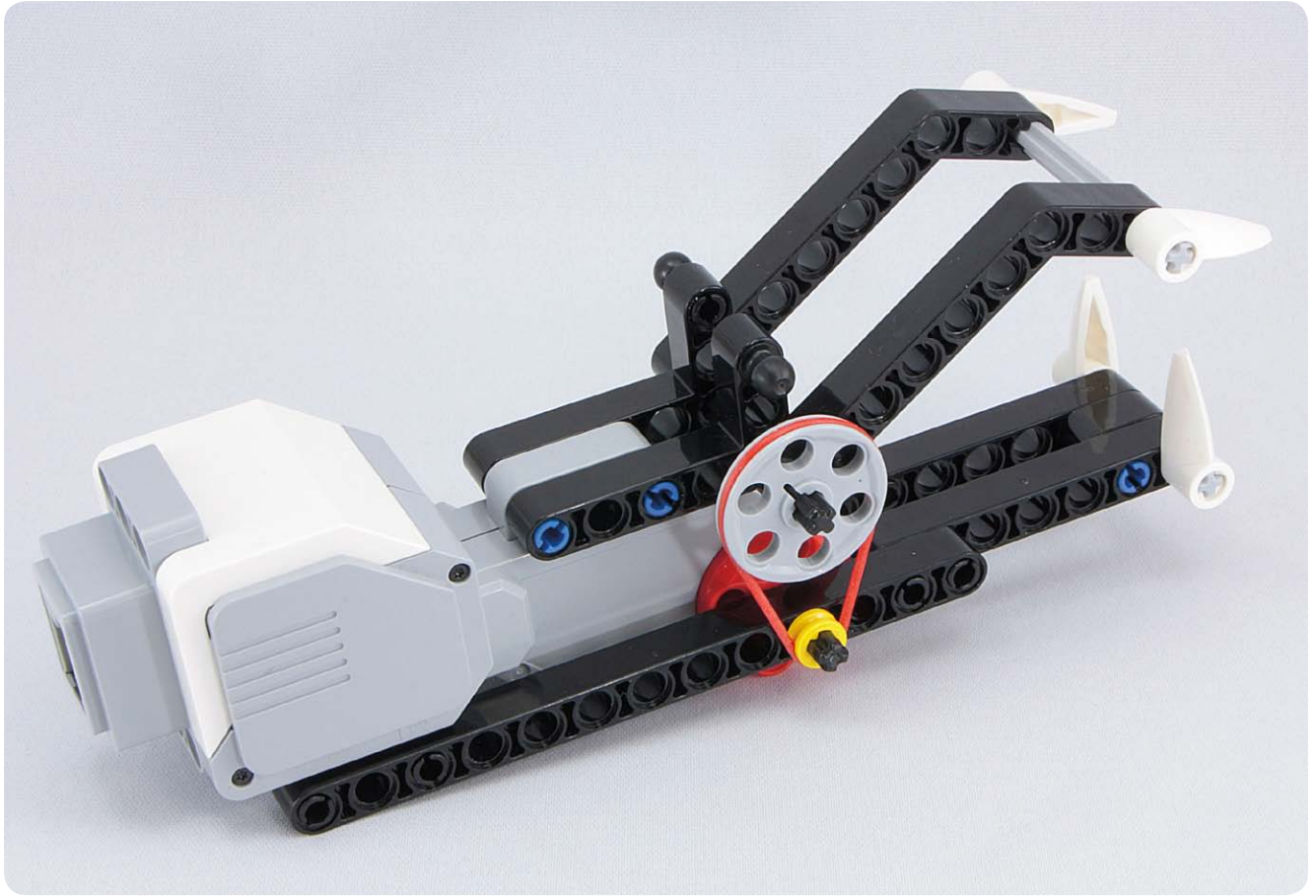



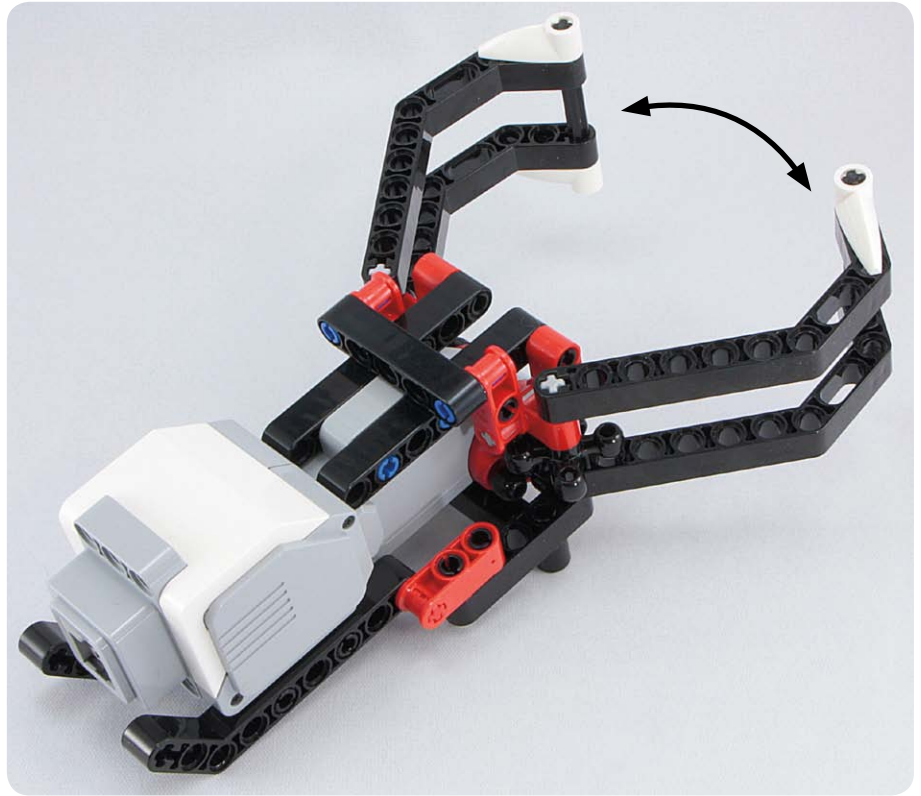
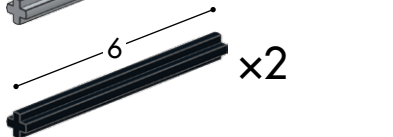
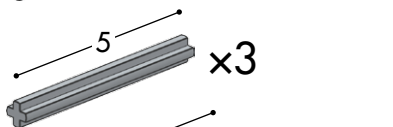
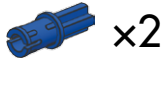
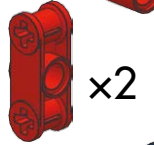
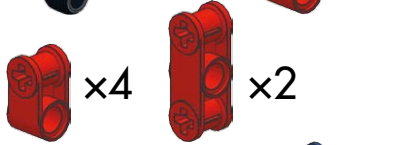
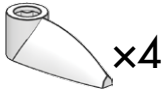
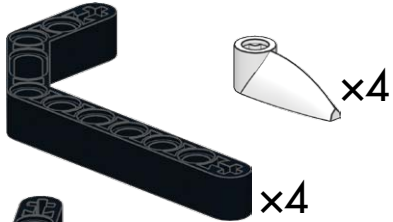
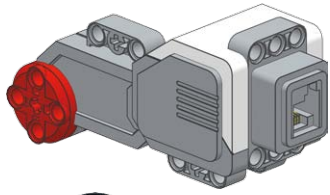

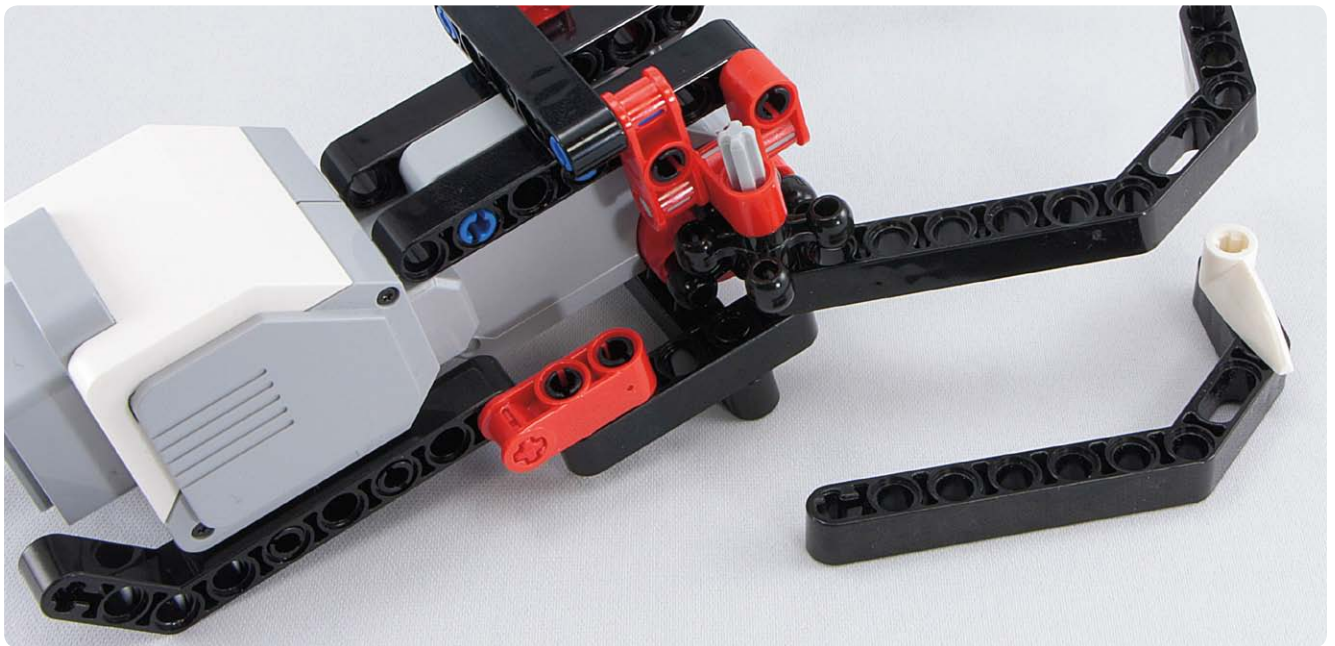
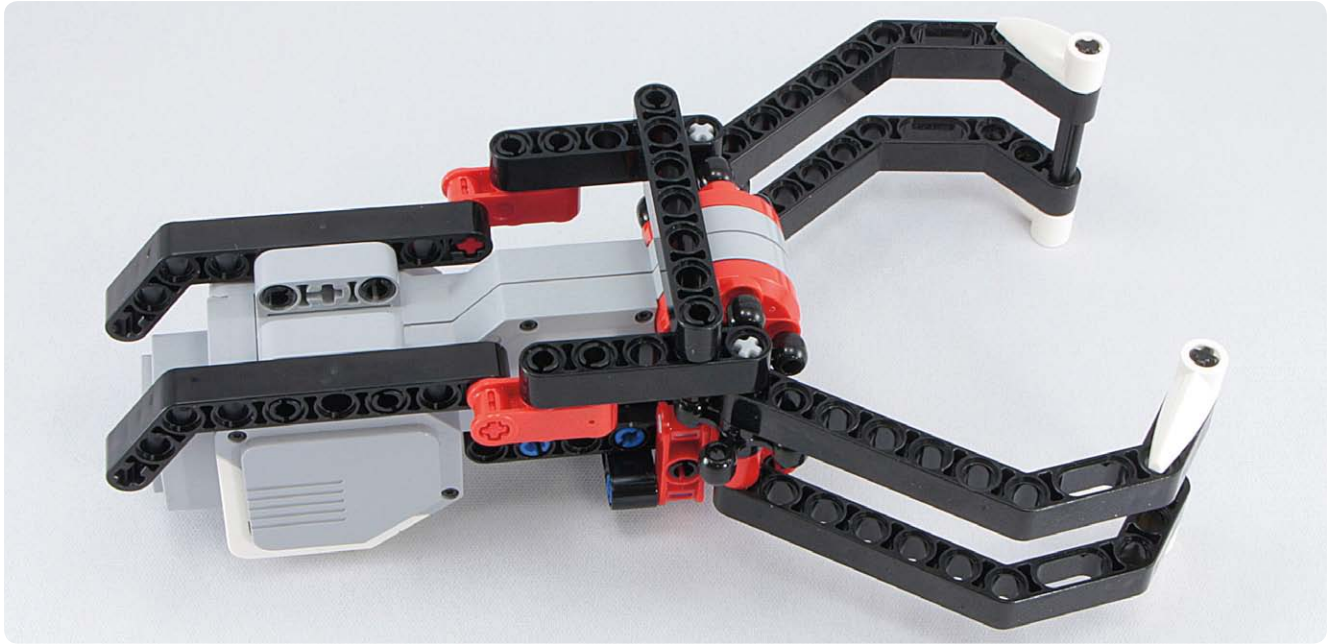



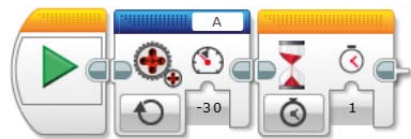

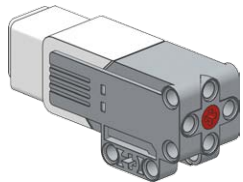
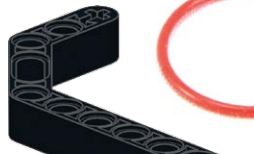

#136



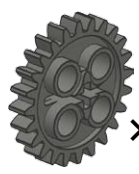

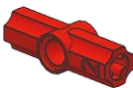
To avoid overextending the mechanism, use this program instead of the standard one.

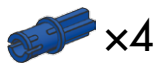
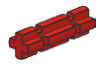

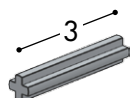
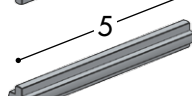
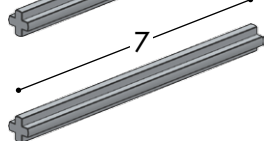

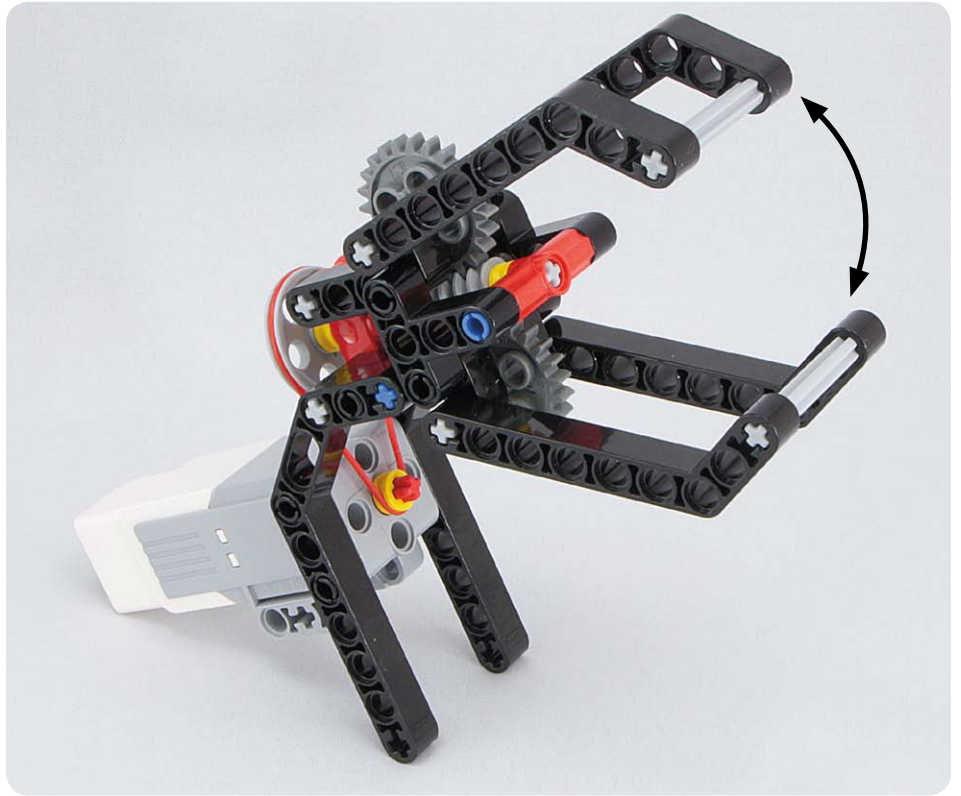





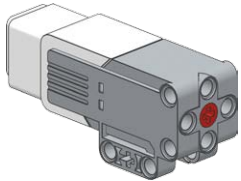
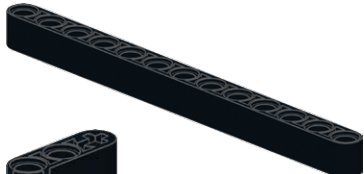





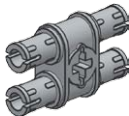
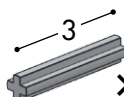
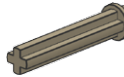

- 
-  
-  x2
-  x4
-  x4
-  x2
- 
-  x2
- 
- 
- 
-  x10
-  x4
- 
-  x4
- 
-  3
-  x5
-  7





#138

- 
- 
-  x2
-  x2
-  x2
-  x2
- 
-  x2
- 
- 
- 
-  3 x2
-  x4
- 
- 
-  x2
-  x2
-  x2
-  x4
-  x2

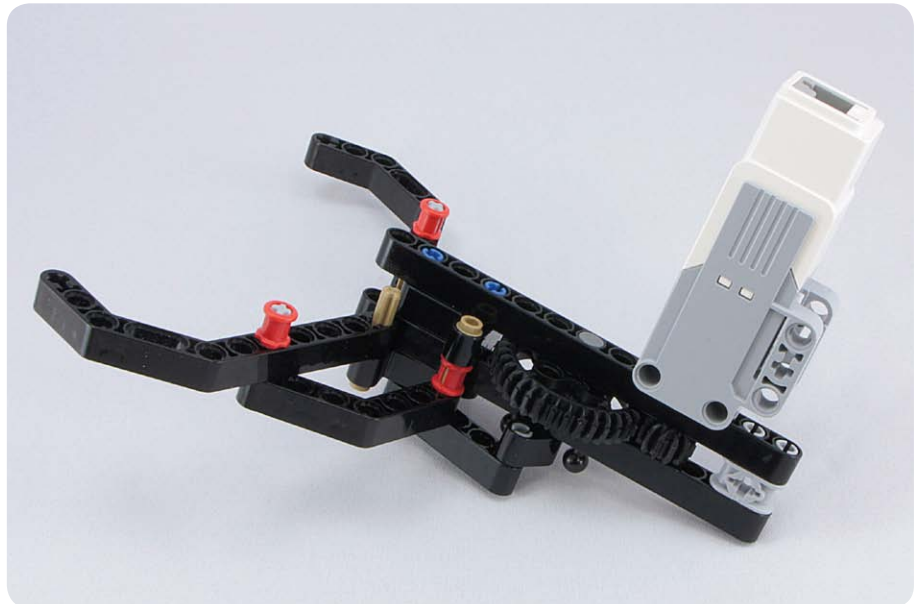





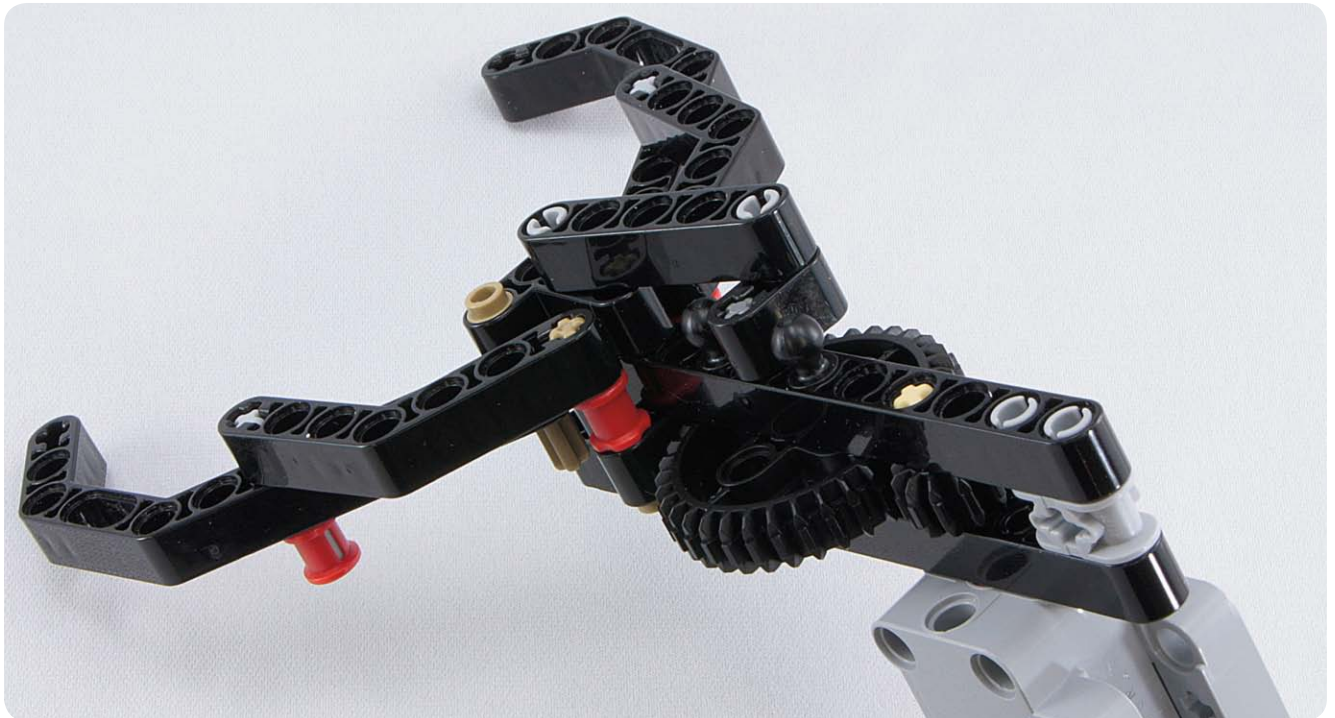
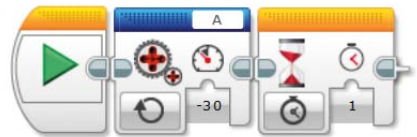



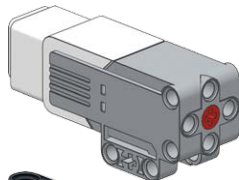













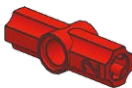

To avoid overextending the mechanism, use this program instead of the standard one.

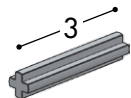
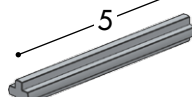
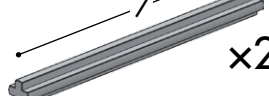

#139

-   
-  x4
-  x2
-  x3
-  x2
-  
-  x4
-   x2  x4
-  x2  x2
-  x4
-  x10
-  x4
-  x2
-  x2
-  3
-  5
-  7 x2
-  x4



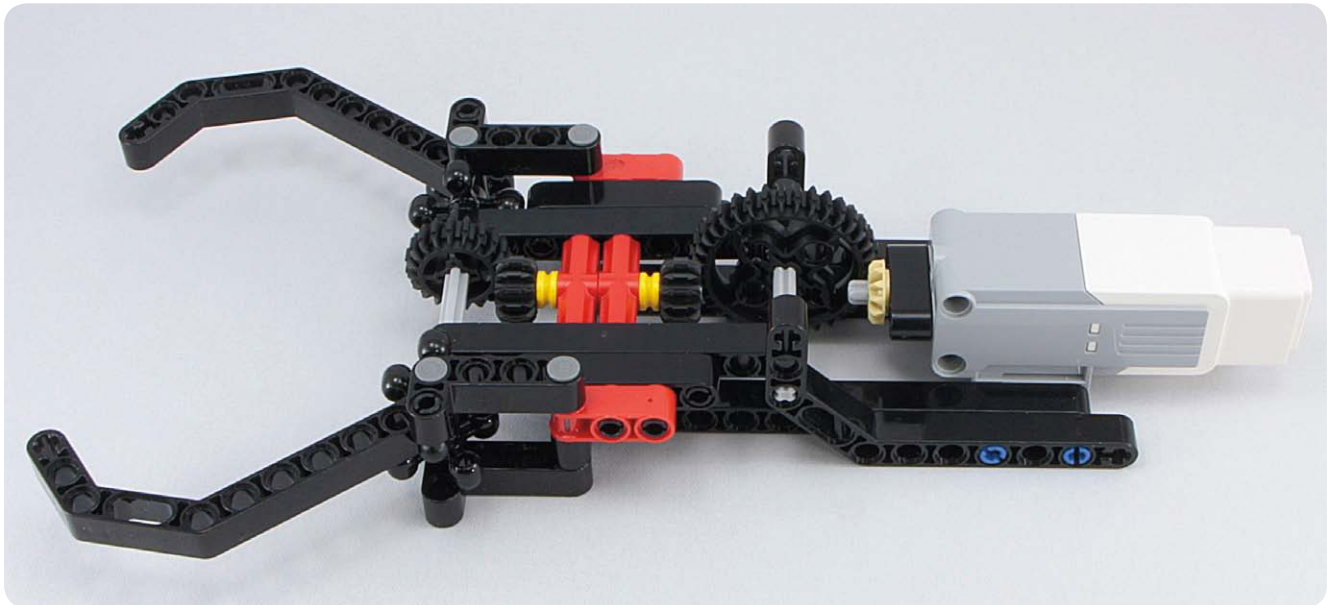
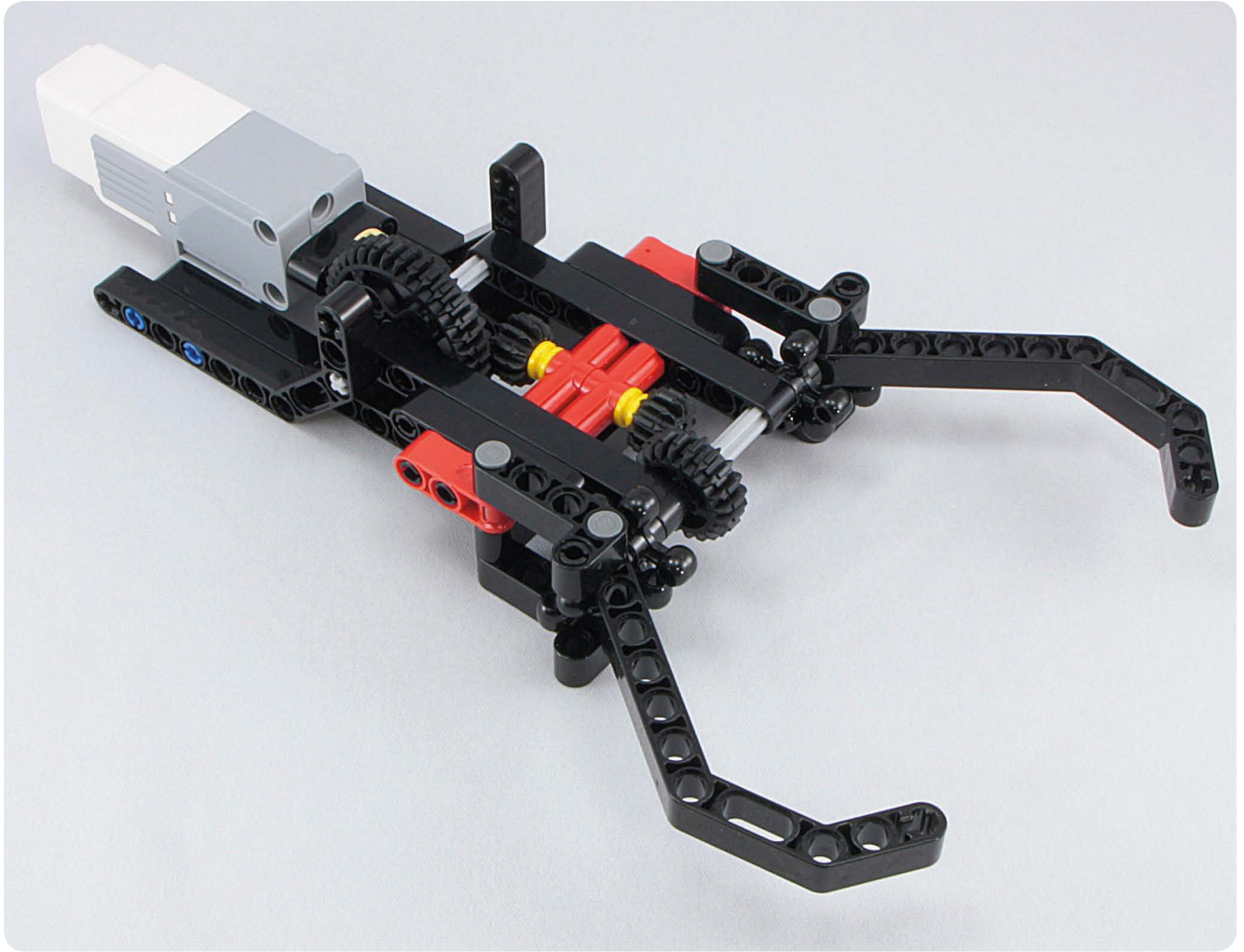



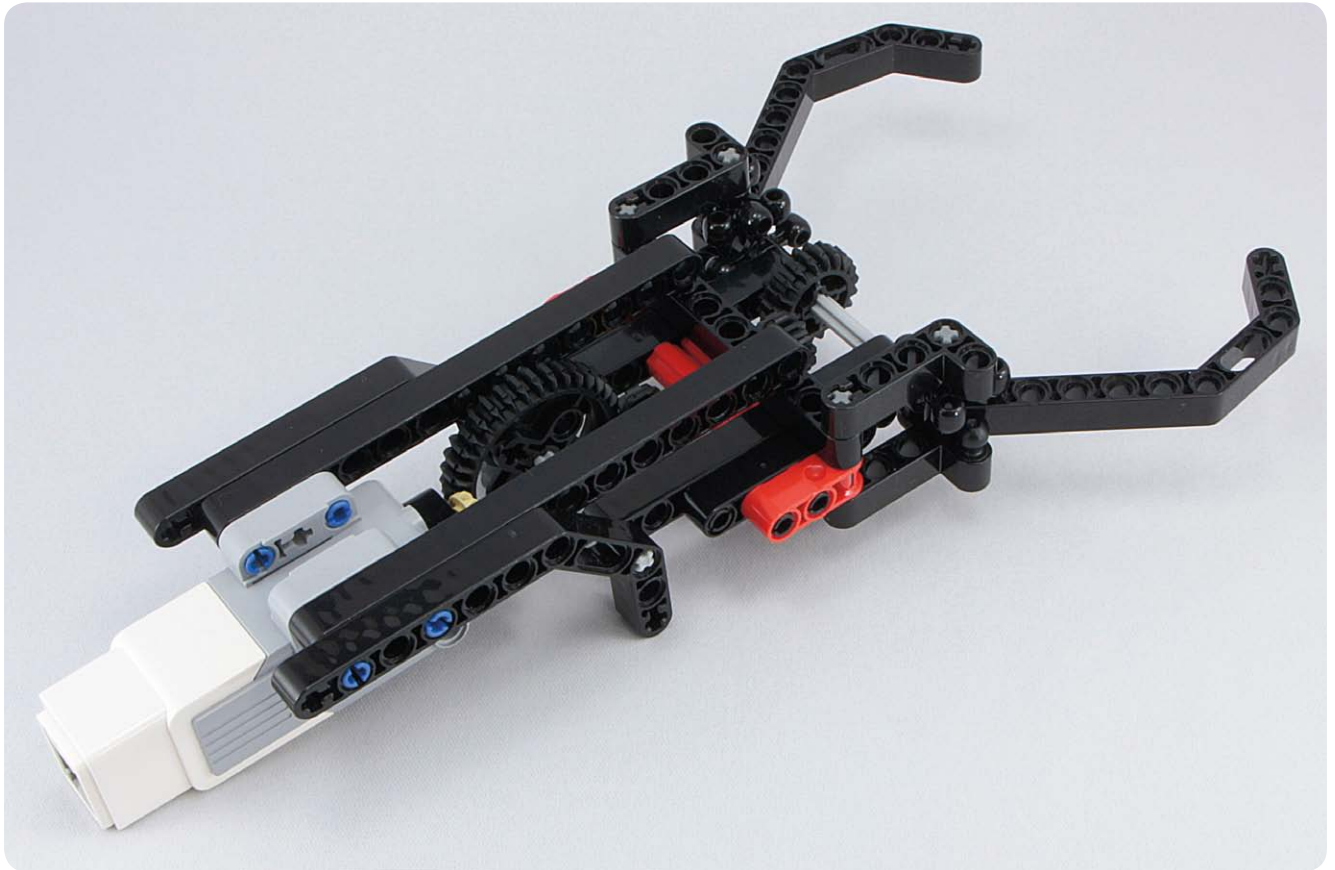
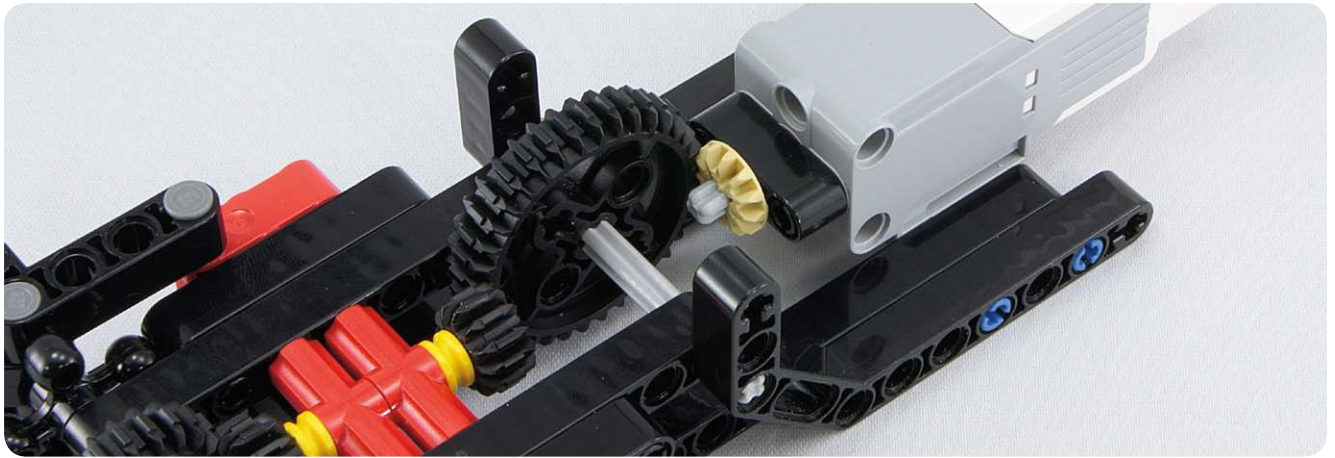

Here's a program for this arm.



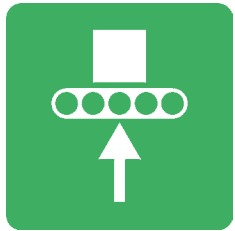

Lifting things

#140

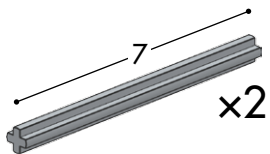
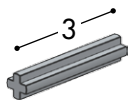
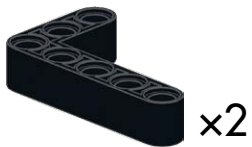
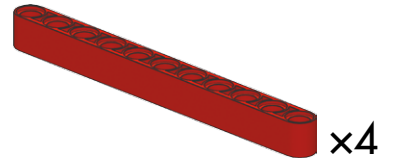
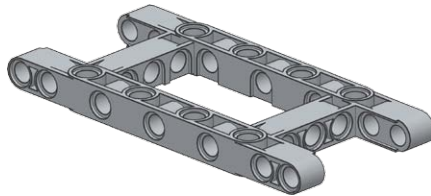
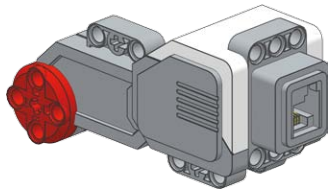

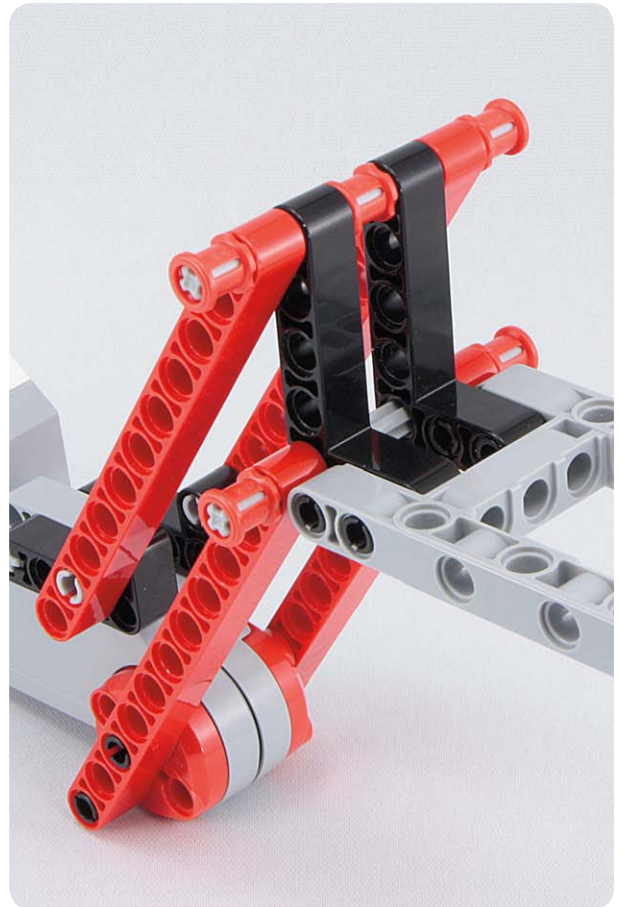
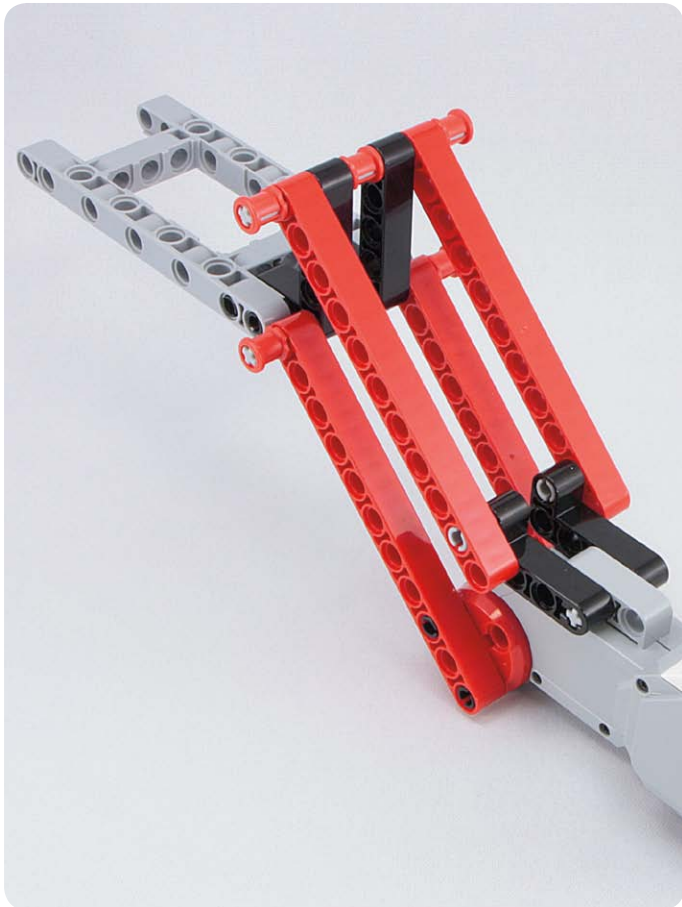
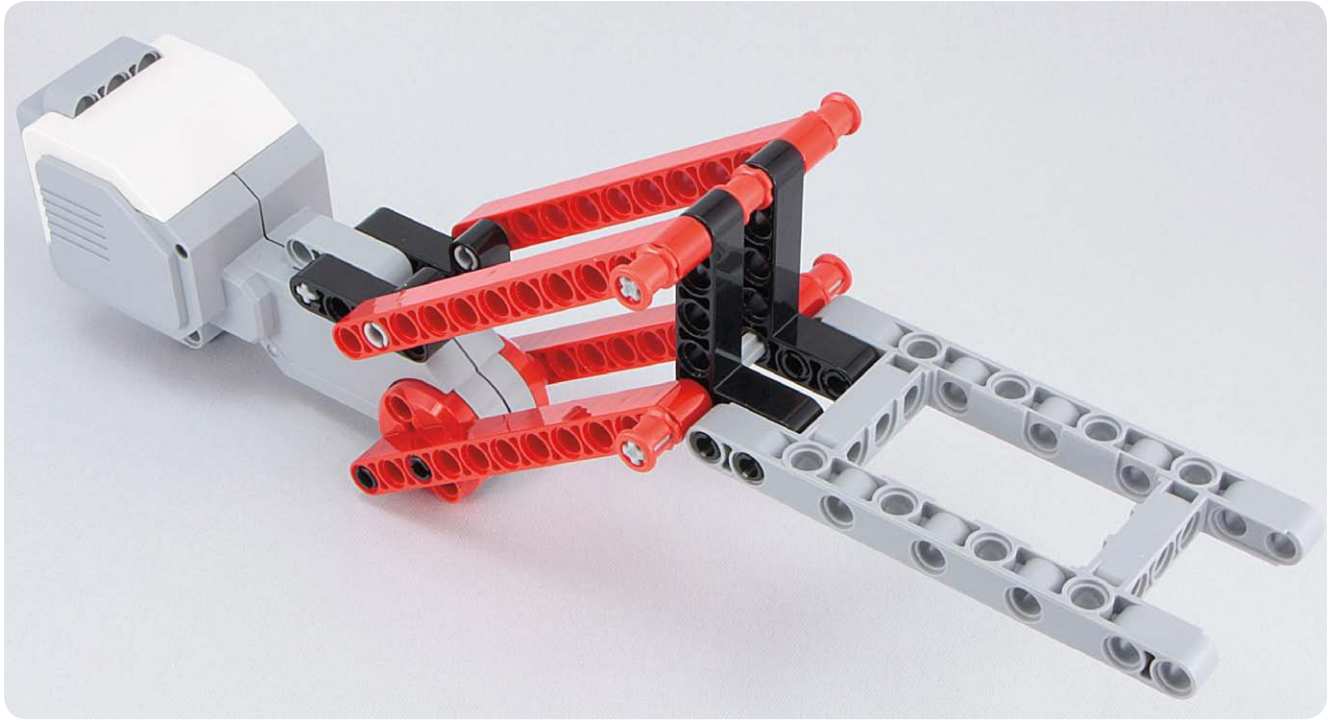

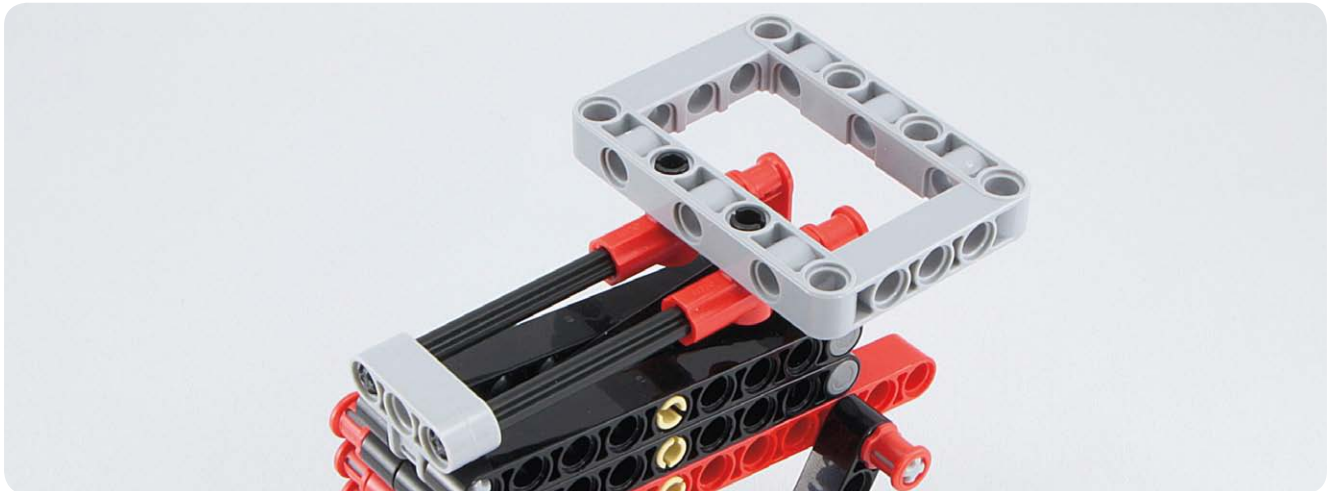

#142

- 
-  x2
-  x2
- 
- 
- 
-  x2
-  x2
- 
-  x2
-  x2
-  3
-  x3
-  5
-  9
-  2

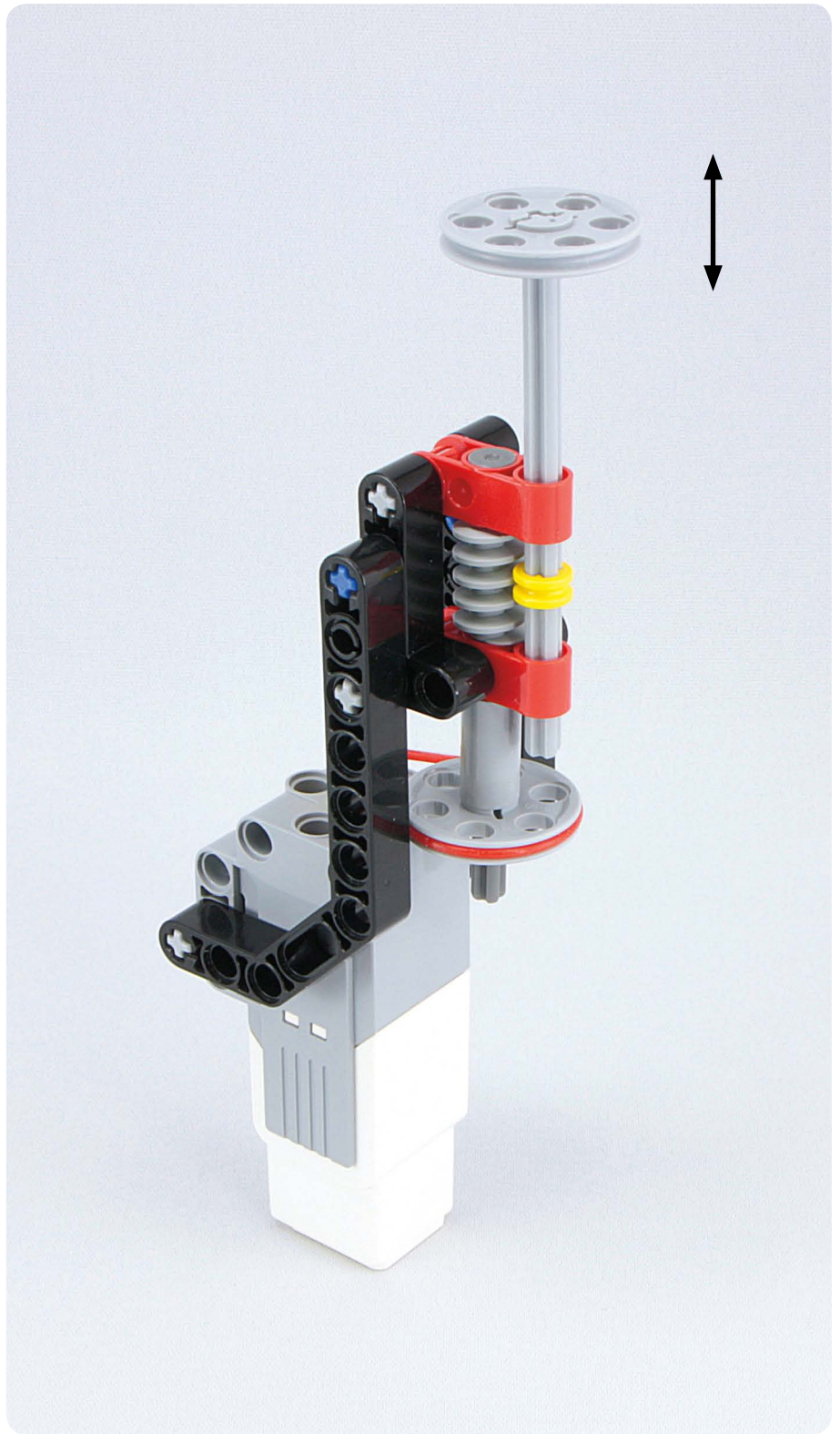

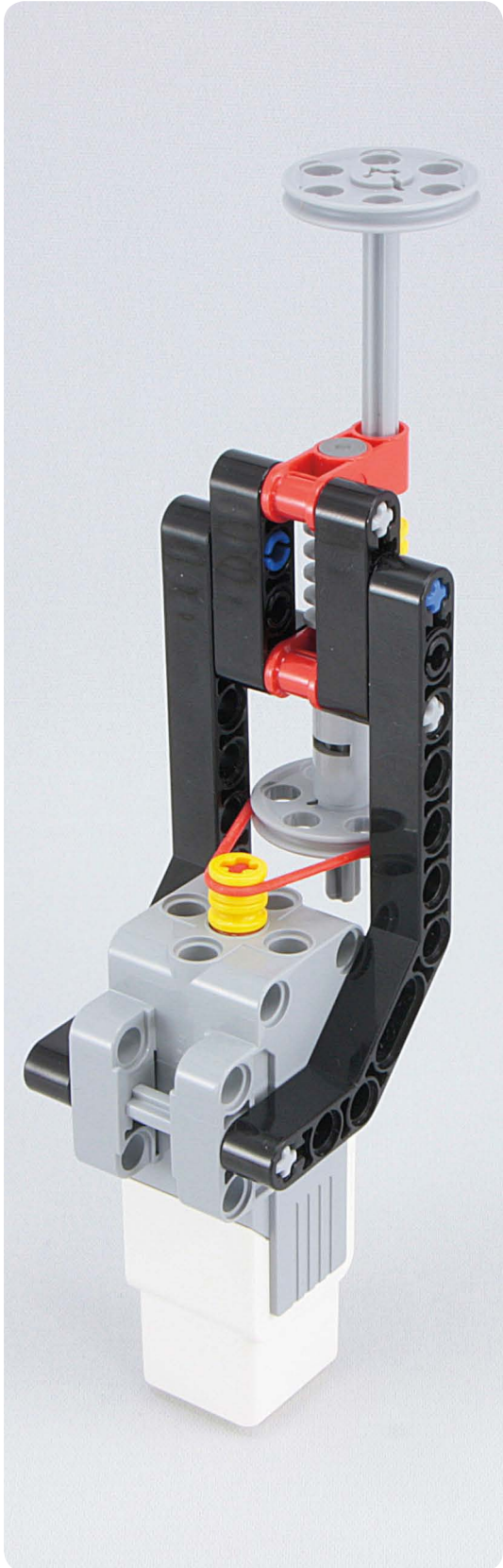

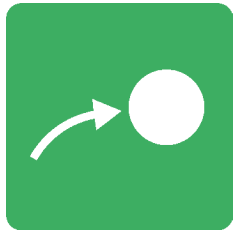

Shooting things

#143

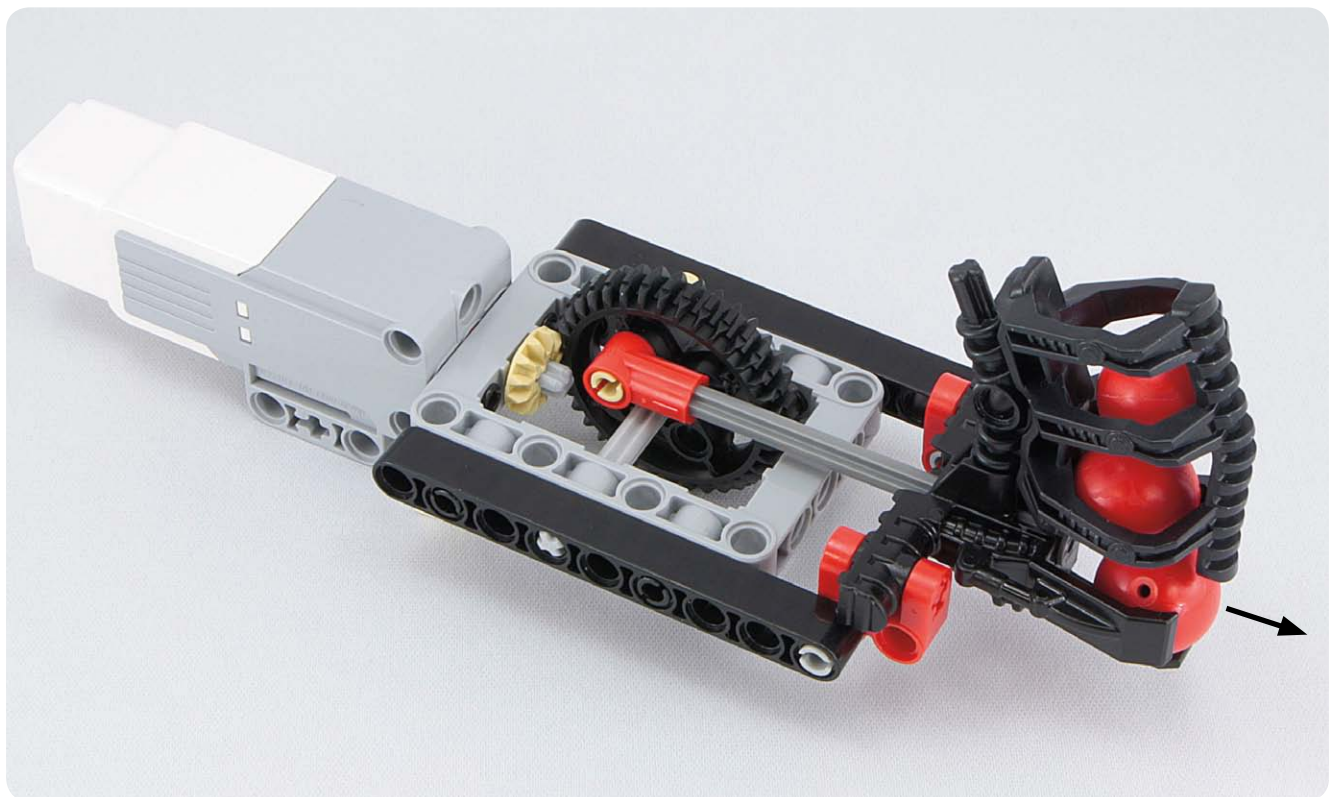
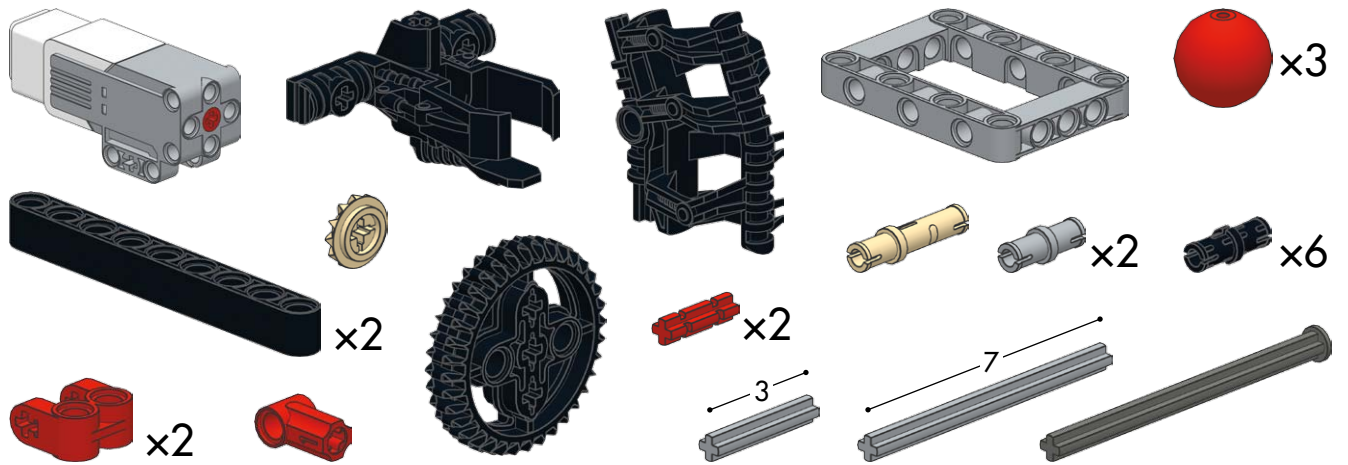

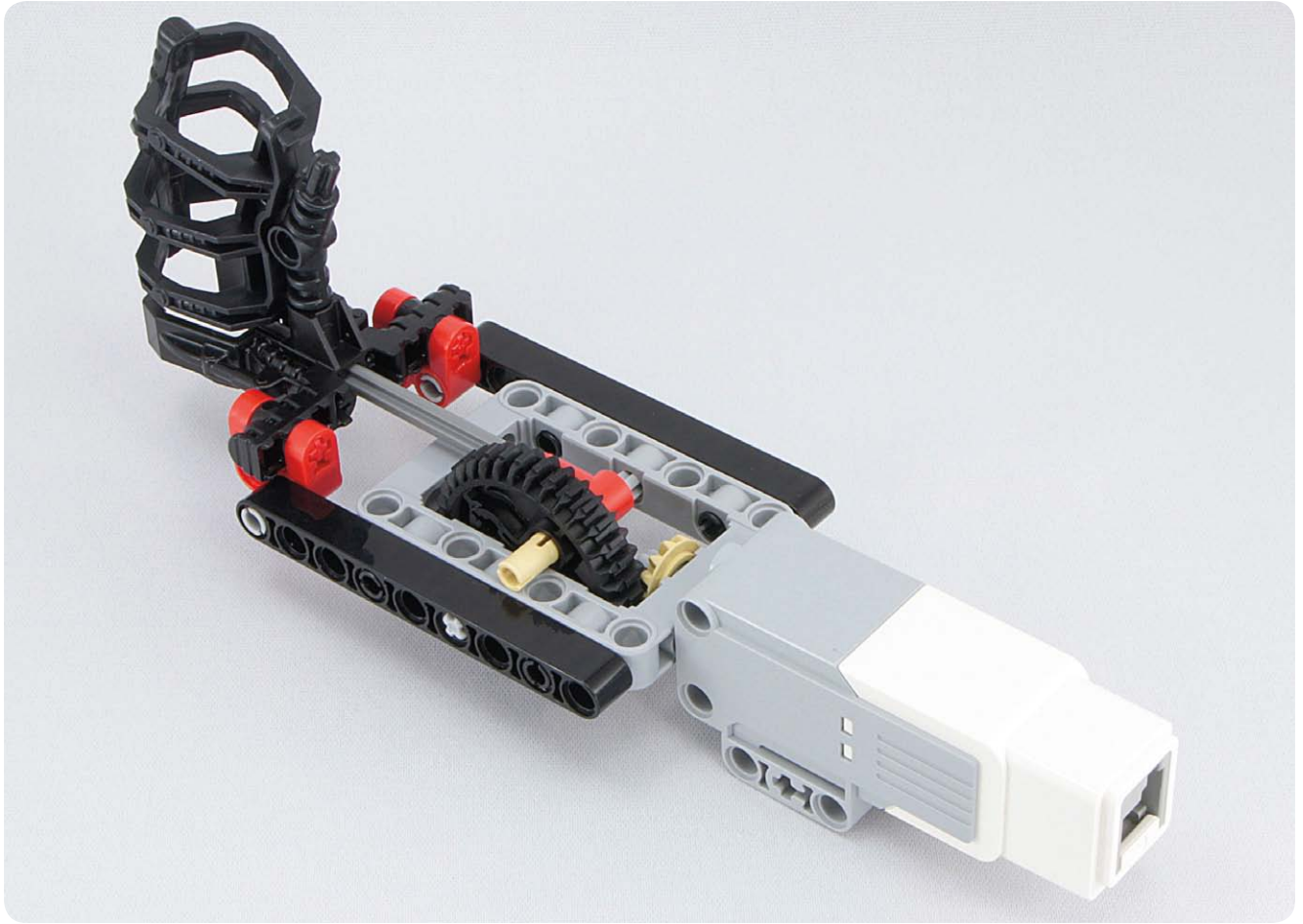

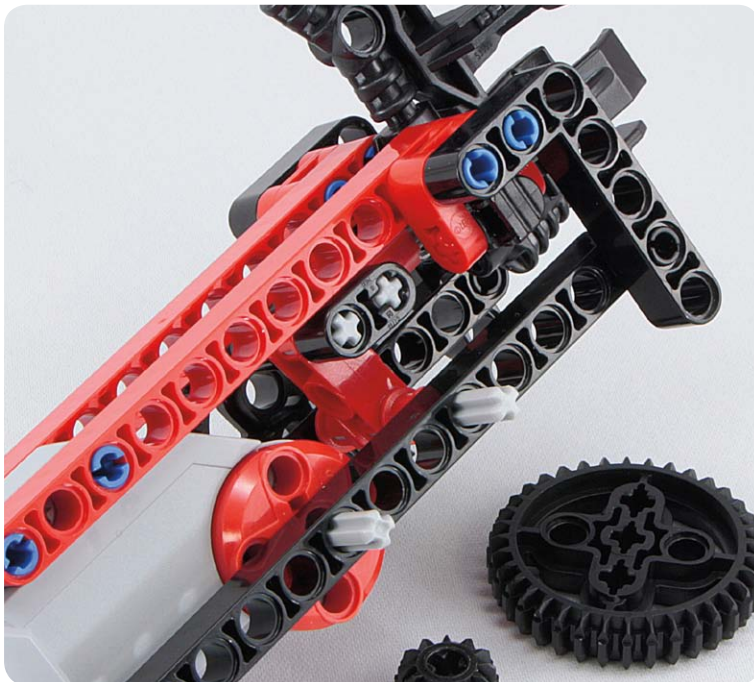
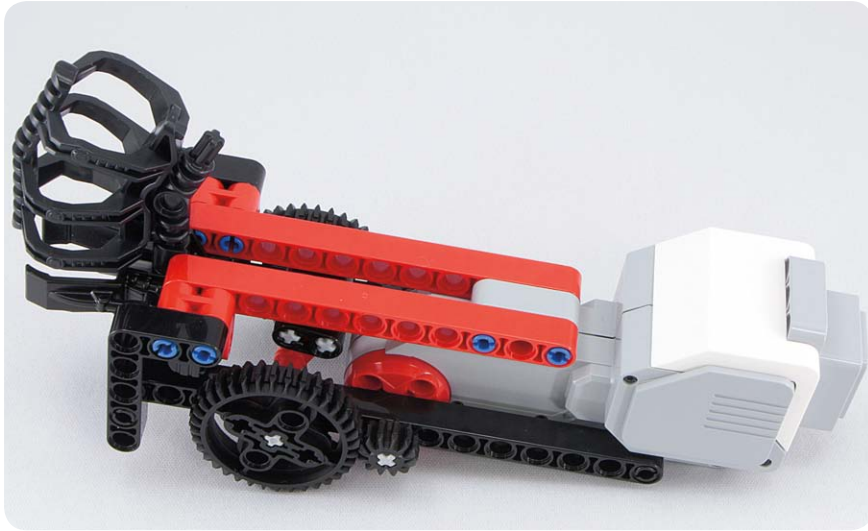

#145

- Red Technic Beam 1x10 **x2**
- Black Technic Beam 1x5 L-shaped **x2**
- Black Technic Beam 1x5 L-shaped **x2**
- Black Technic Beam 1x5 L-shaped **x2**
- Black Technic Beam 1x5 L-shaped **x2**
- Black Technic Gear 24-tooth
- Red Technic Ring
- Red Technic Connector 1x2
- Red Technic Connector 1x2
- Red Technic Connector 1x2
- Grey Technic Pin with Friction Ridge **x2**
- Grey Technic Pin with Friction Ridge (2-way)
- Red Technic Pin with Friction Ridge **x2**
- Black Technic Pin with Friction Ridge **x2**
- Grey Technic Pin with Friction Ridge (3) **x2**
- Blue Technic Pin with Friction Ridge **x2**
- Grey Technic Pin with Friction Ridge (5) **x2**
- Black Technic Pin with Friction Ridge **x4**
- Grey Technic Pin with Friction Ridge (7) **x2**
- Red Technic Pin with Friction Ridge
- Grey Technic Pin with Friction Ridge
- Grey Technic Pin with Friction Ridge





#146

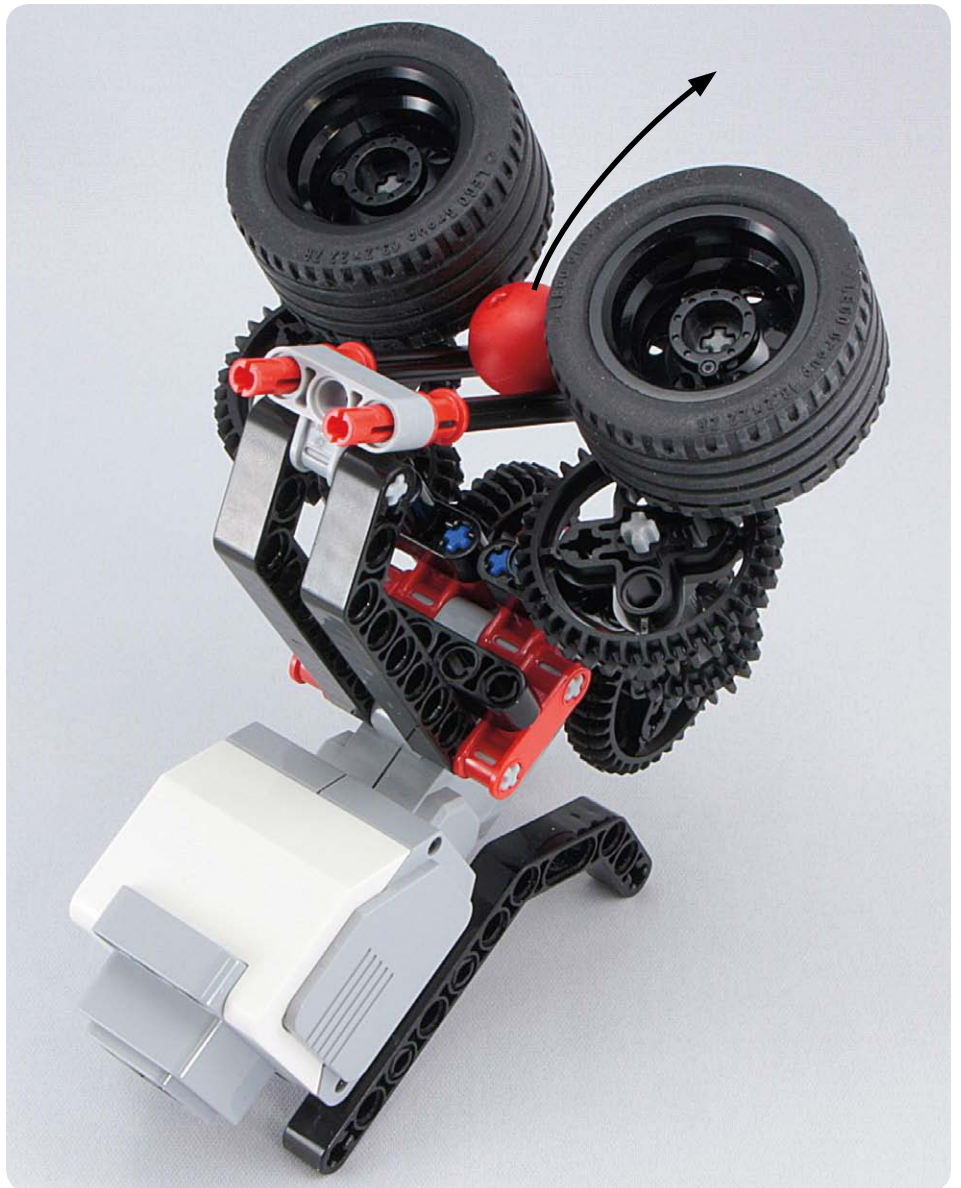
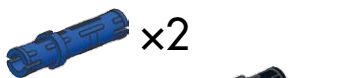
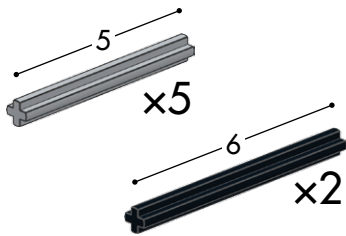
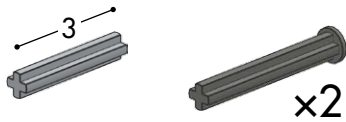
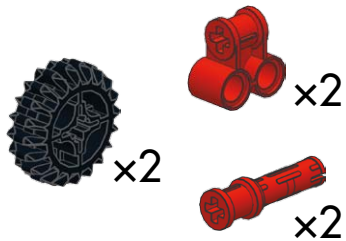
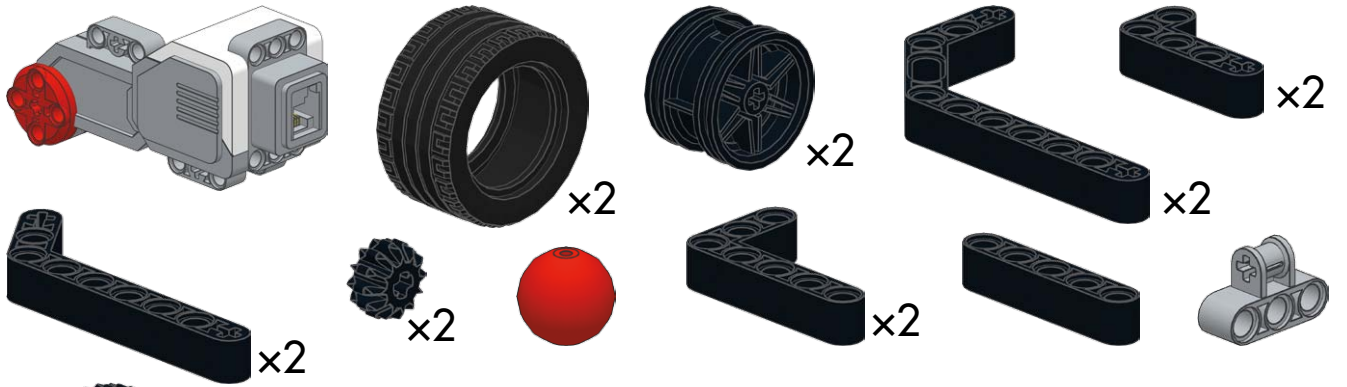

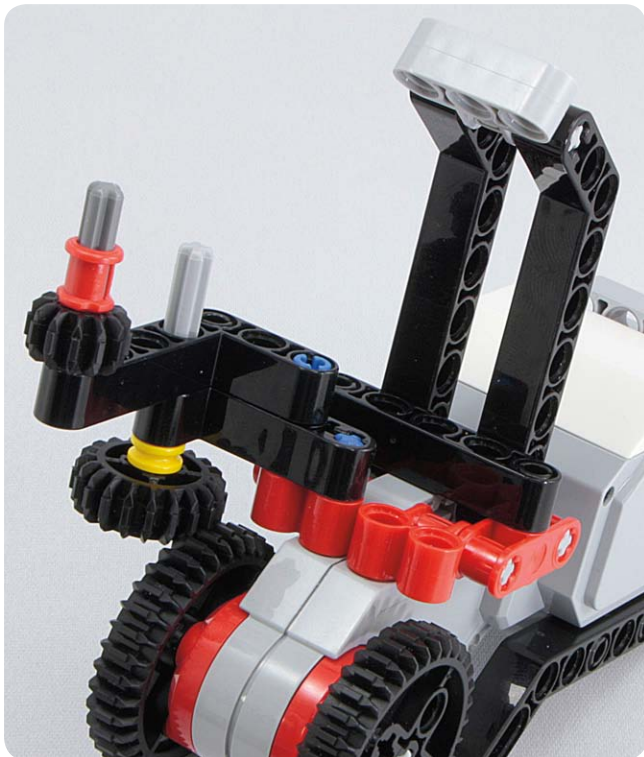

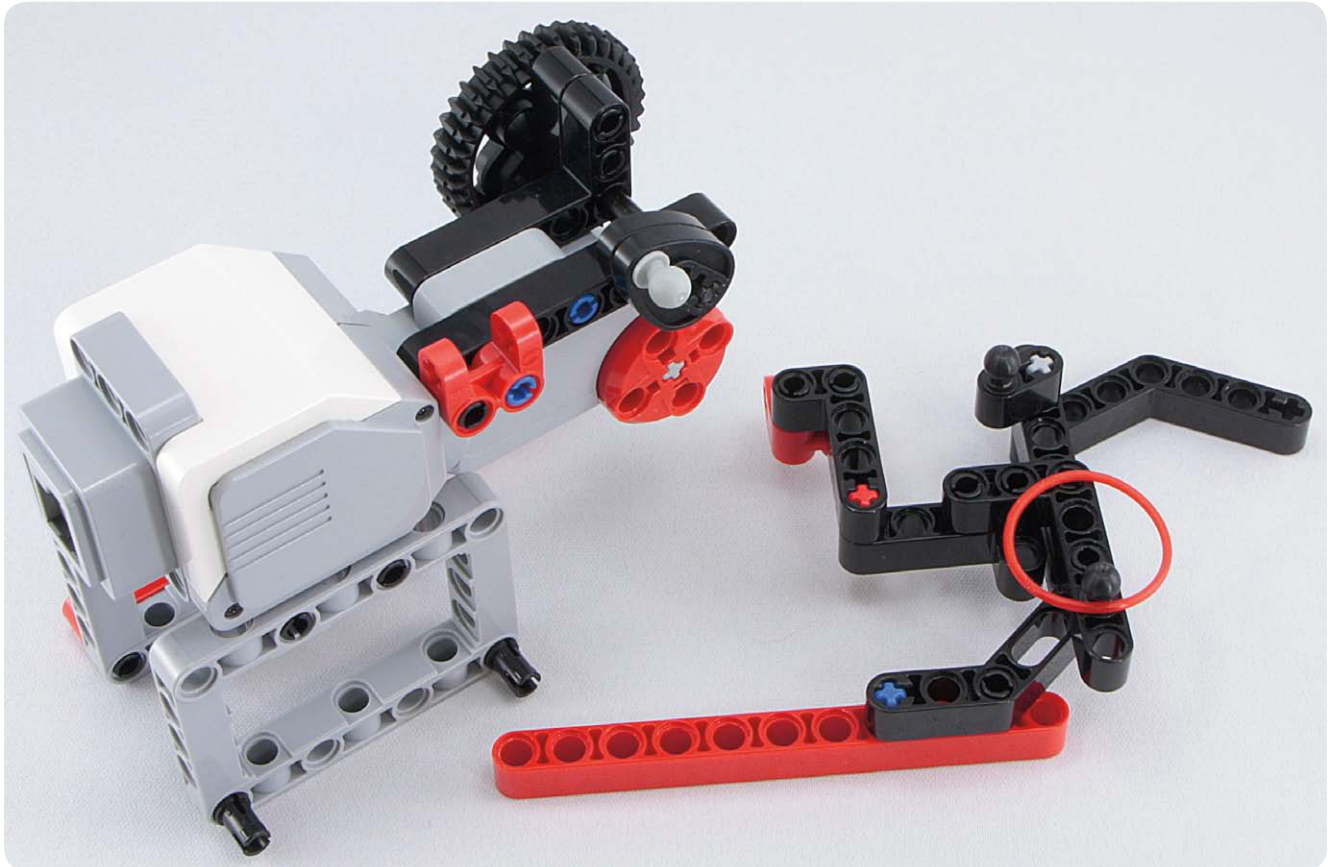
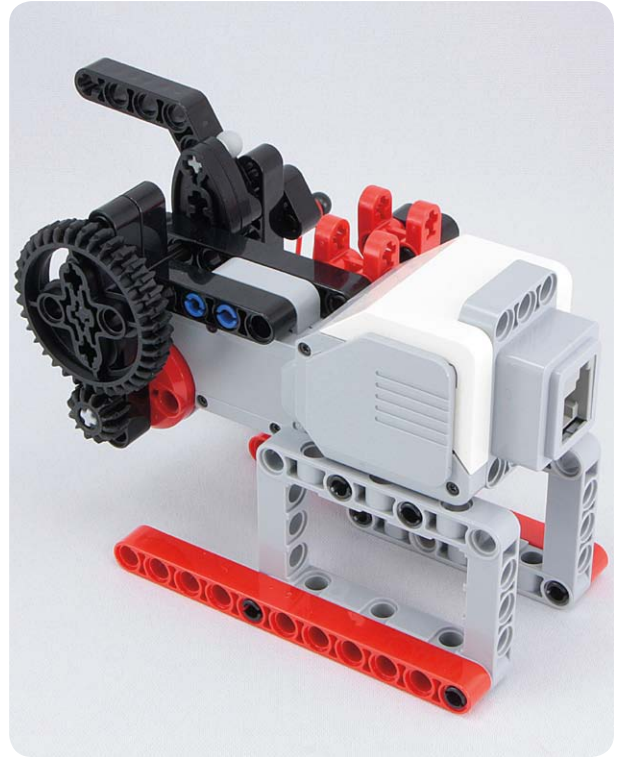
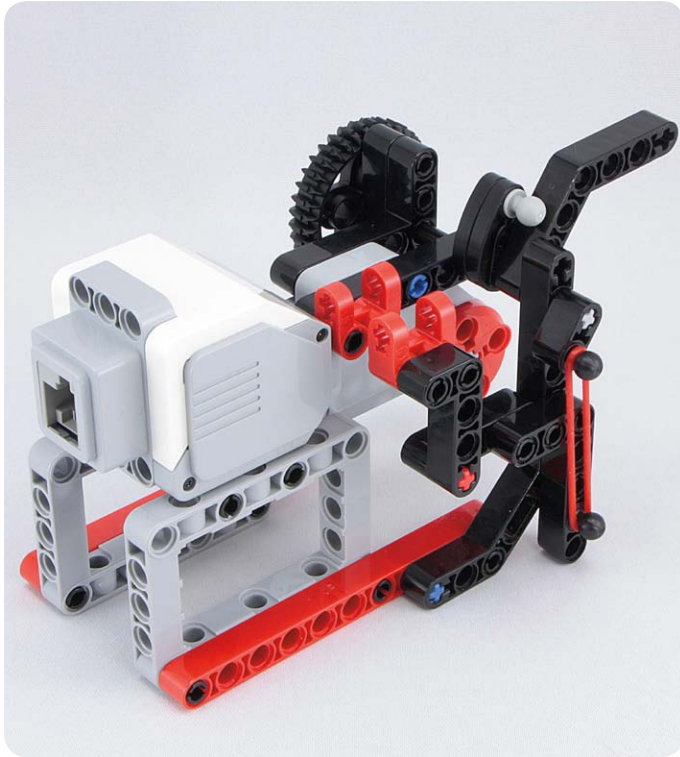

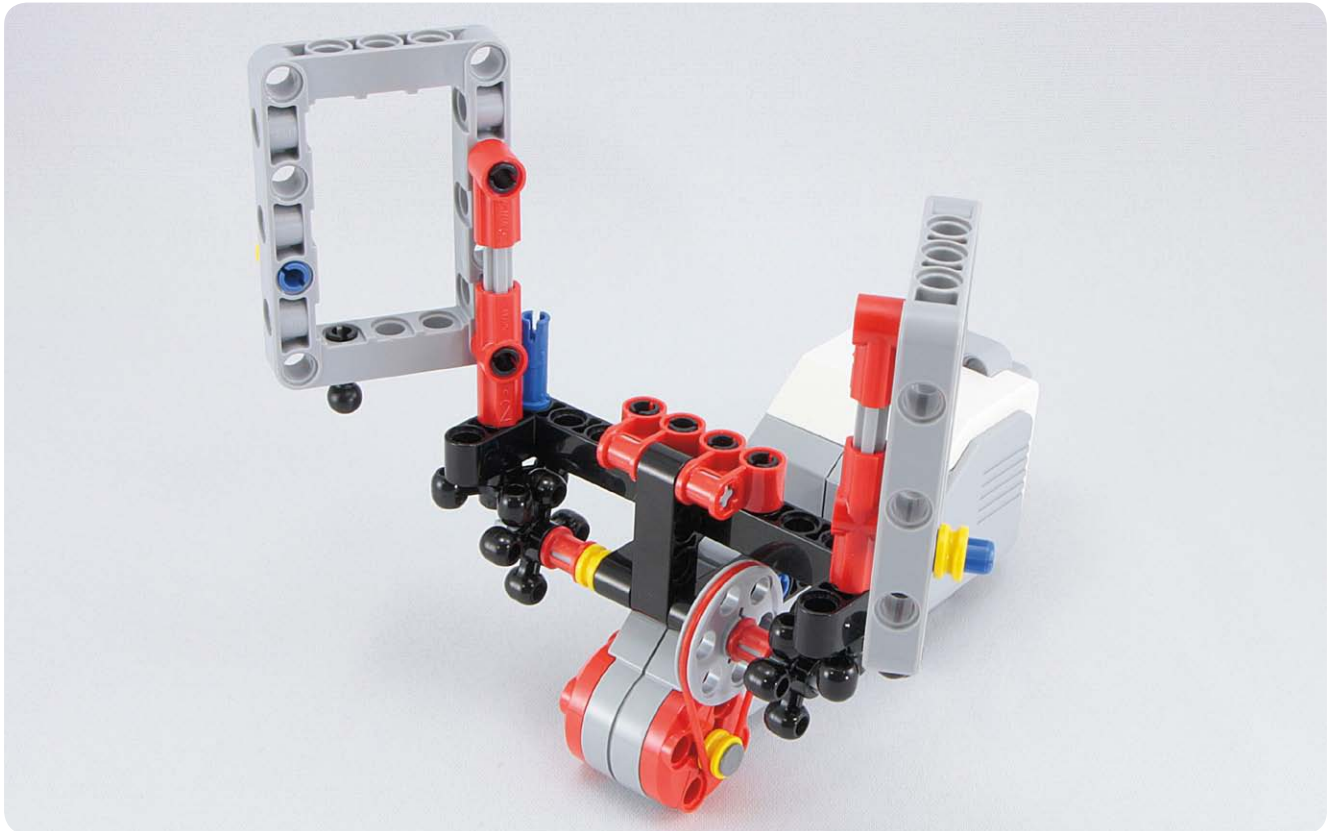
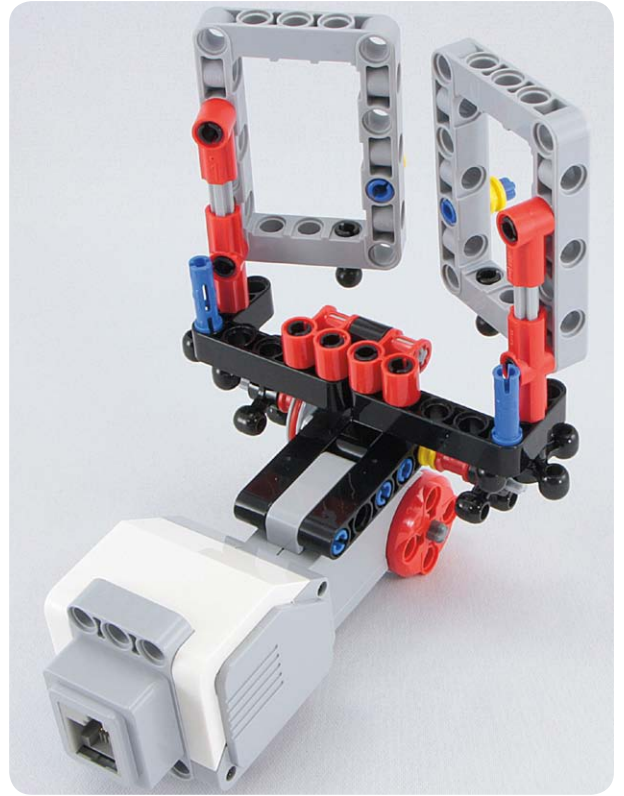
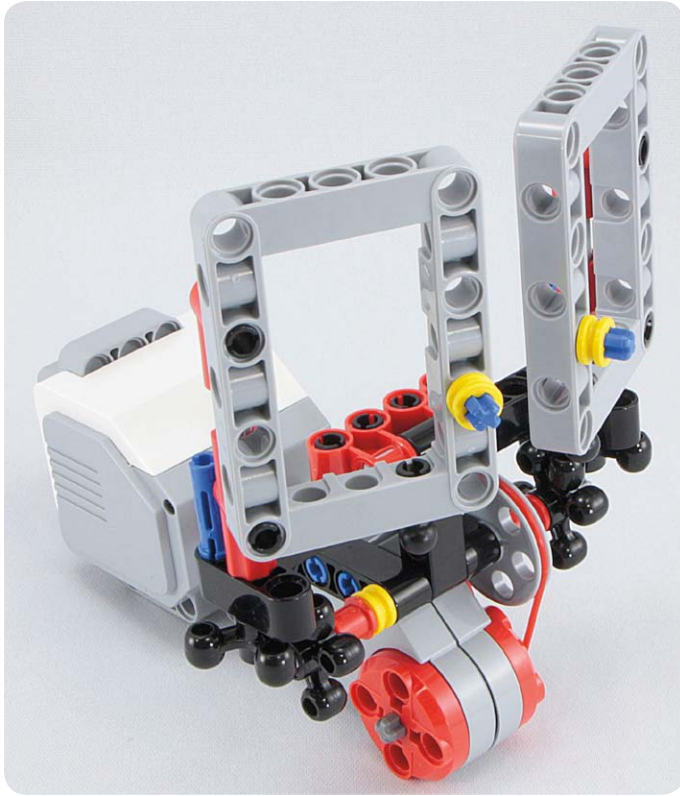

#149

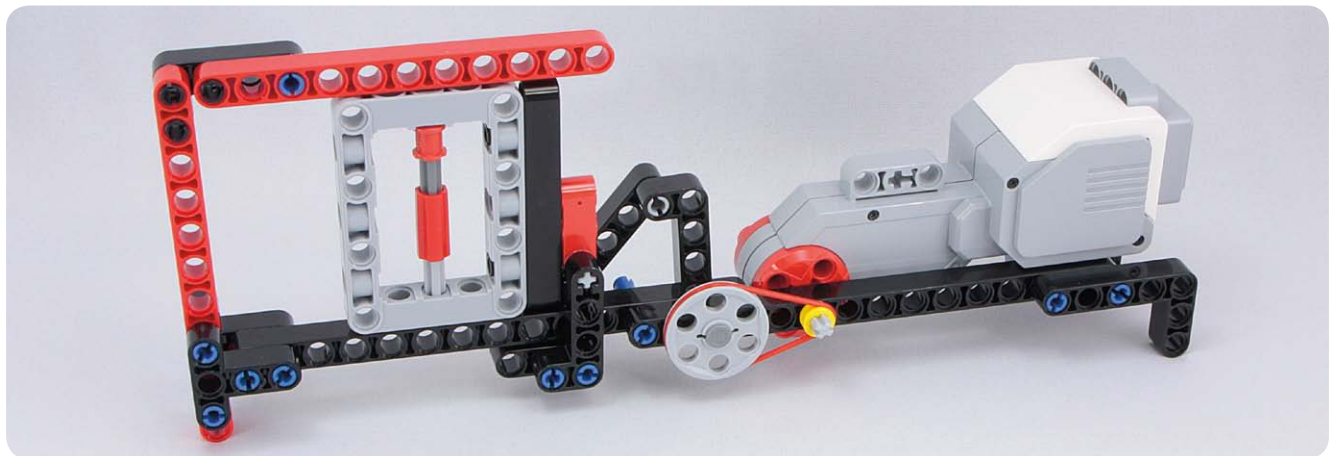
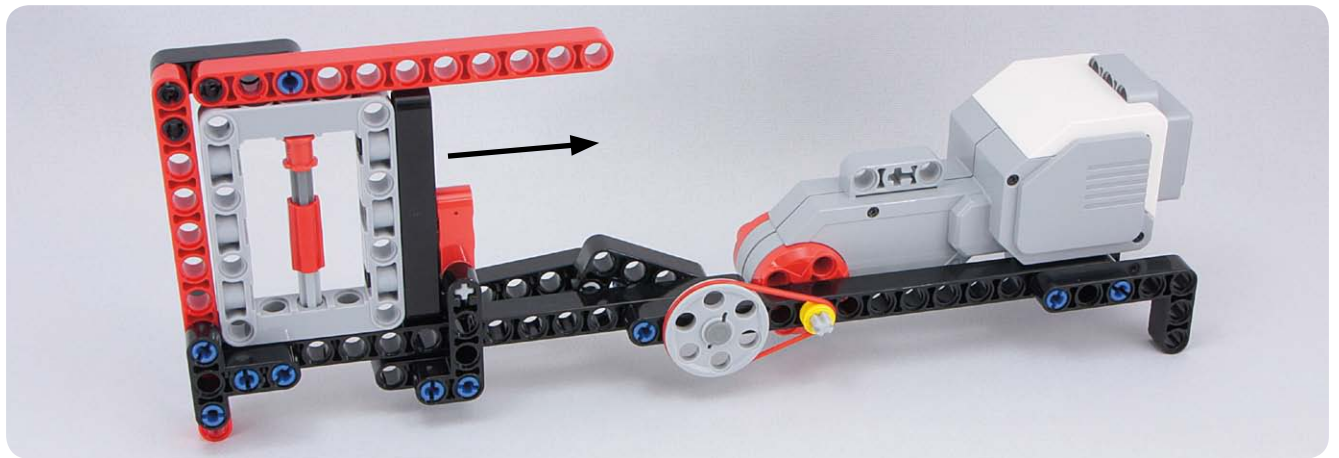
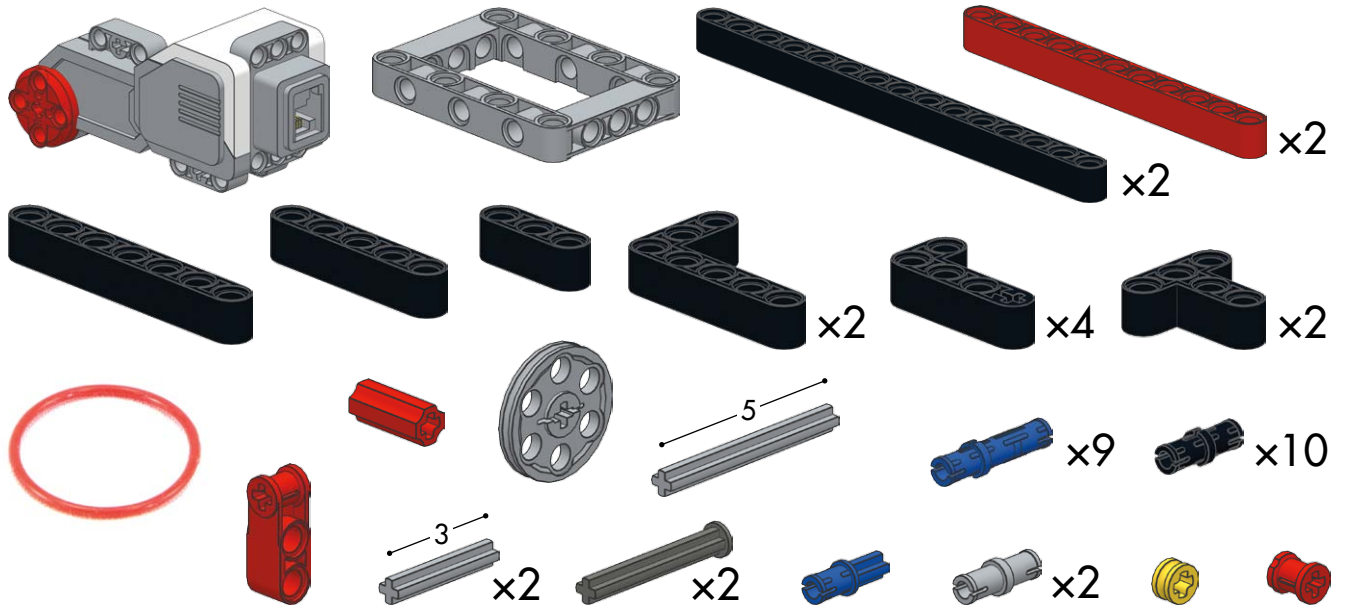

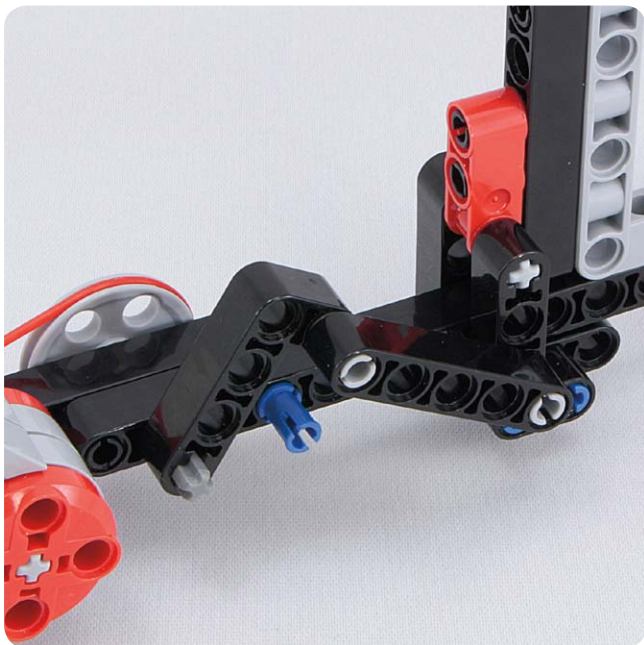
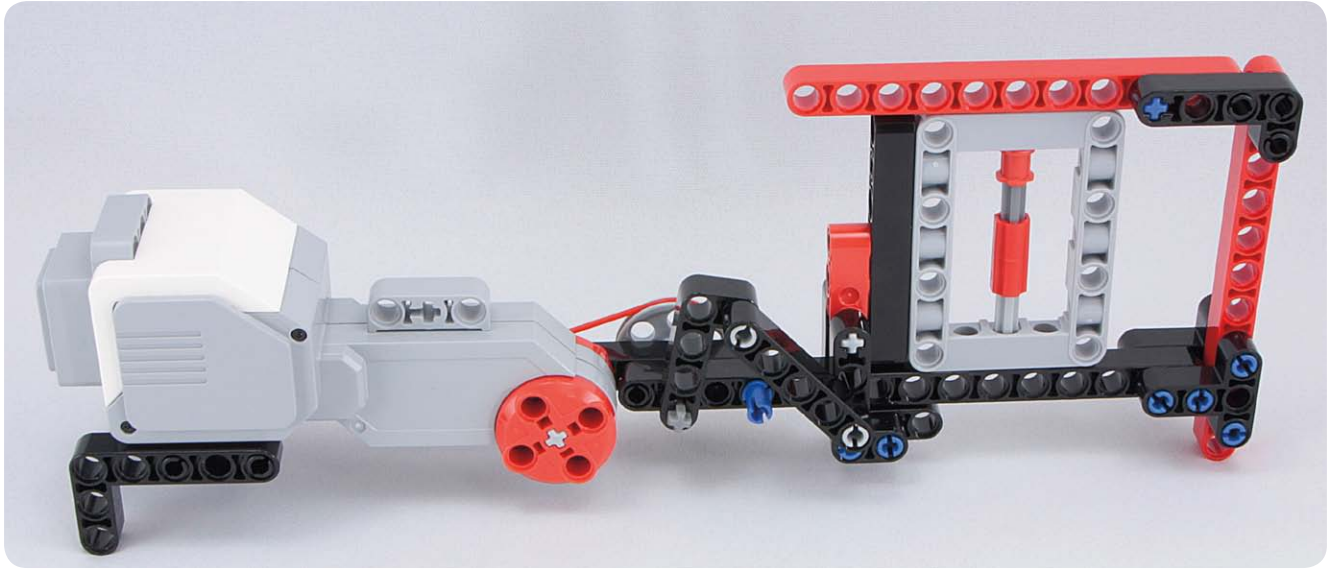

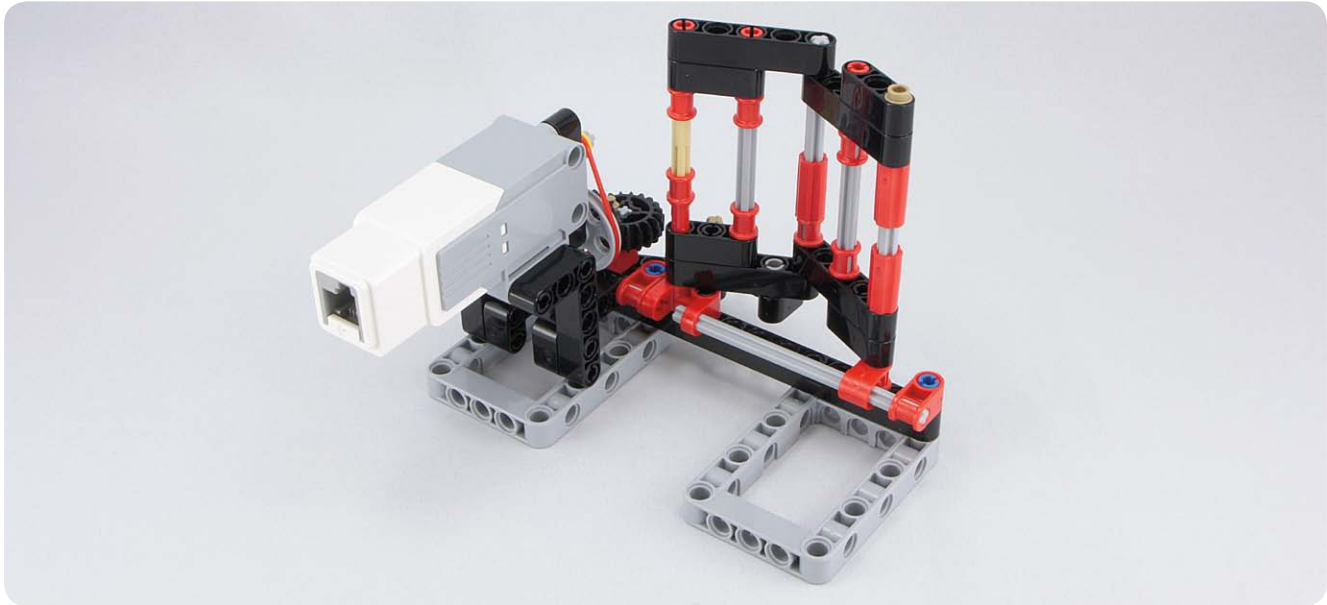
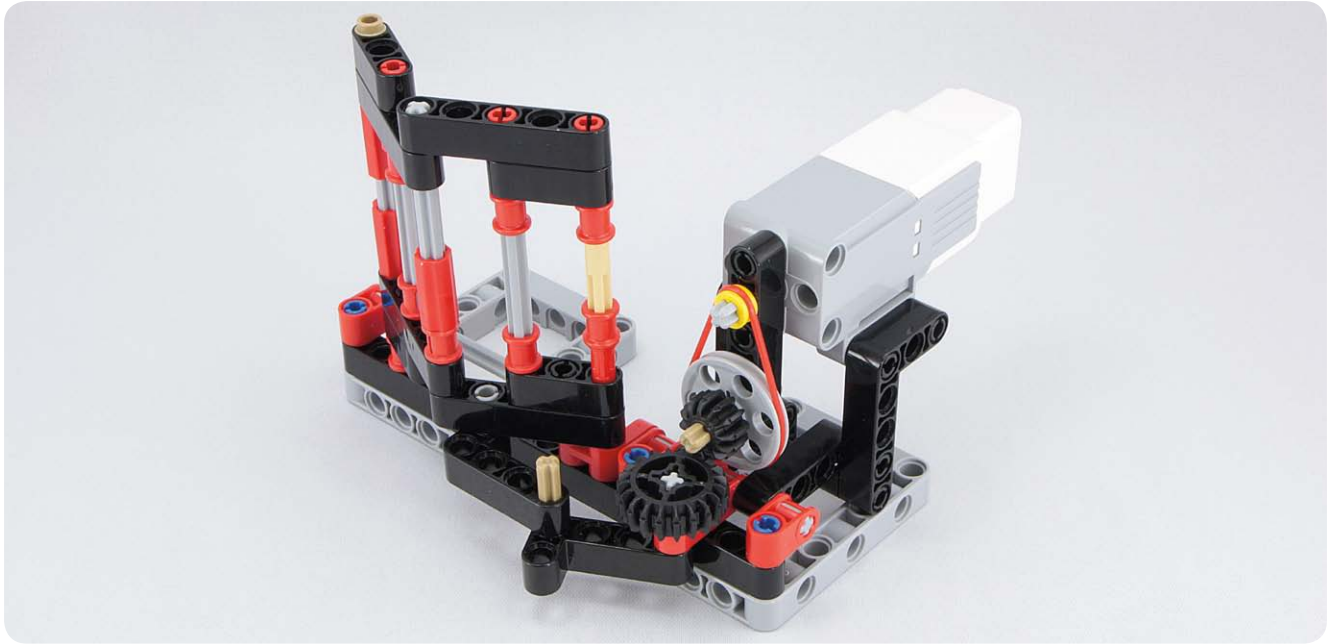

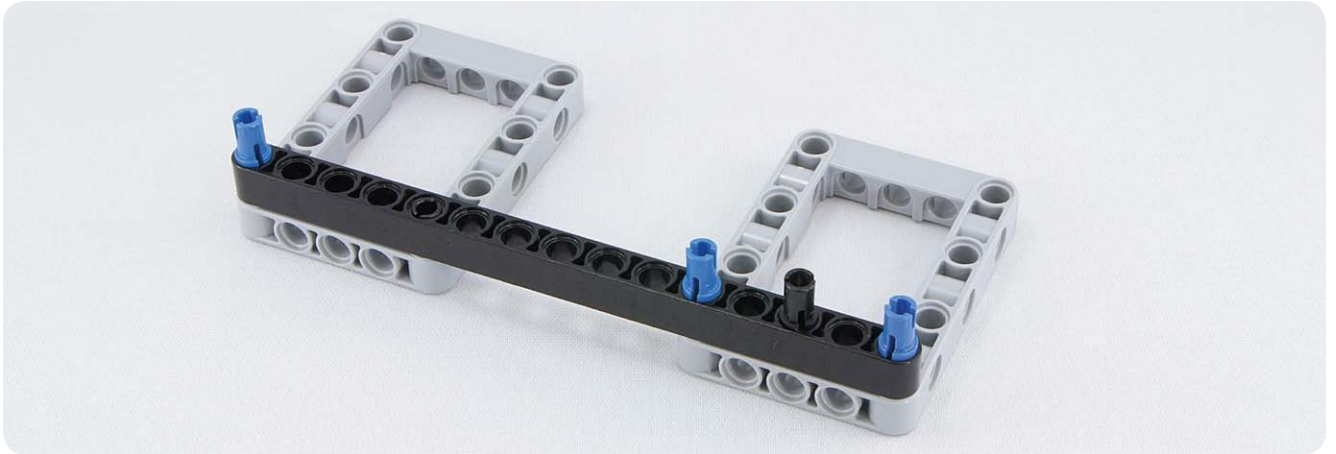

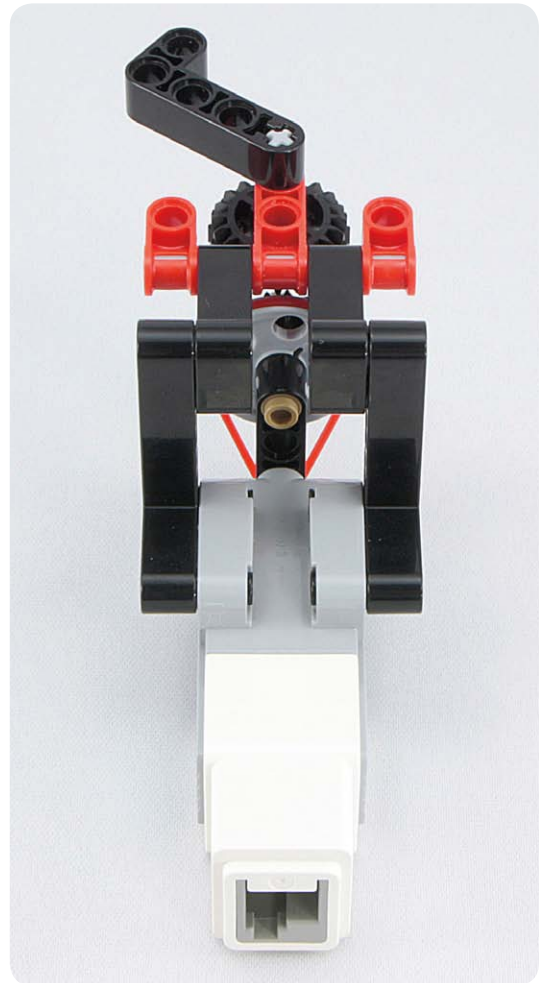

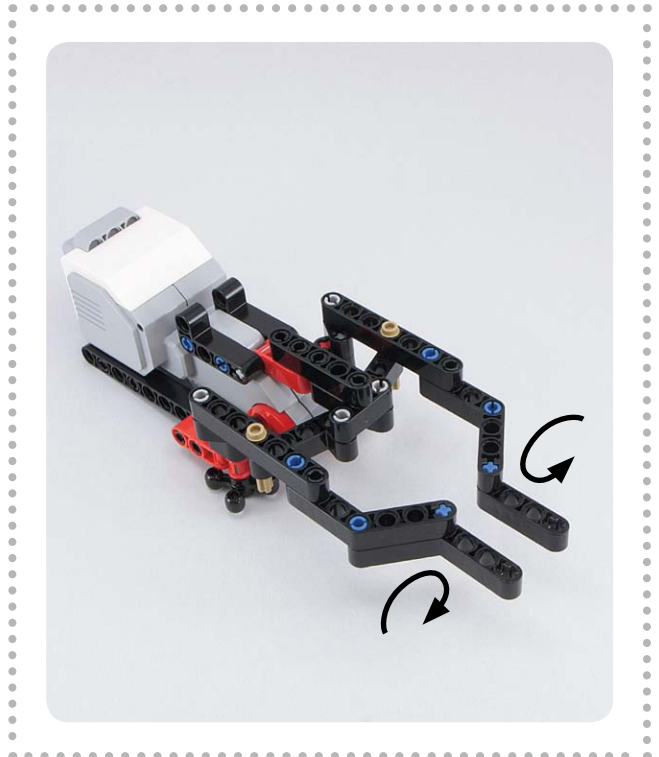
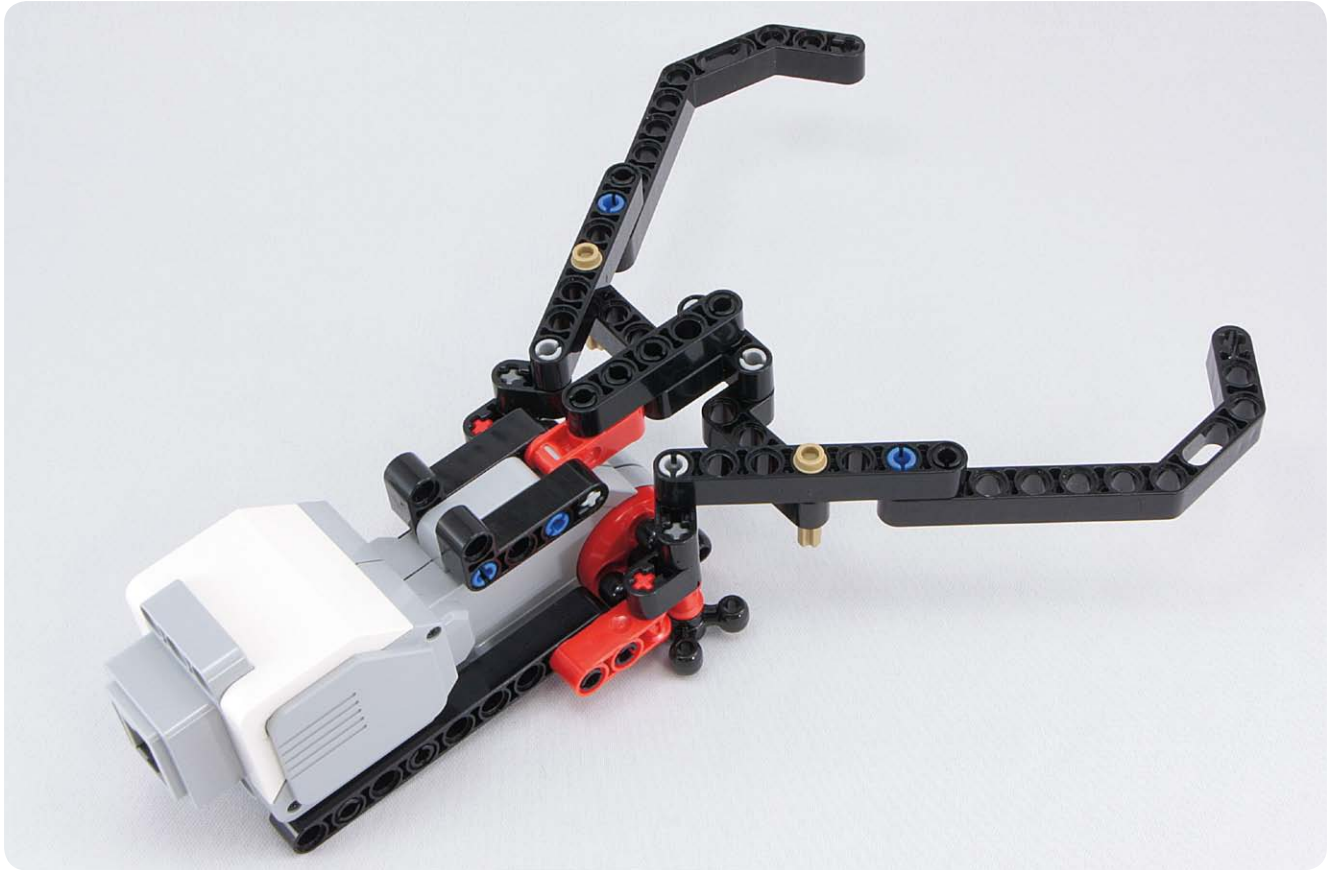

#152

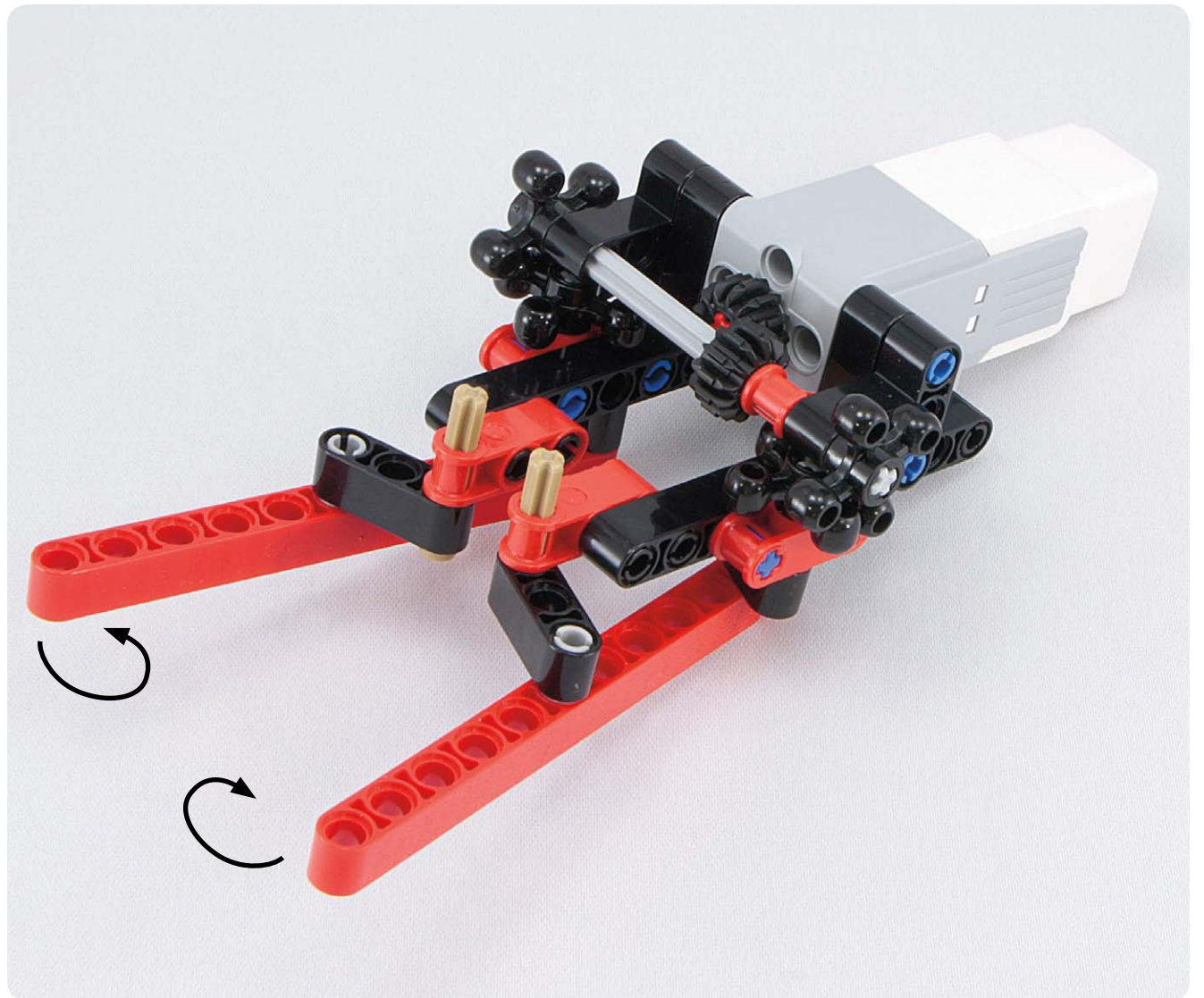
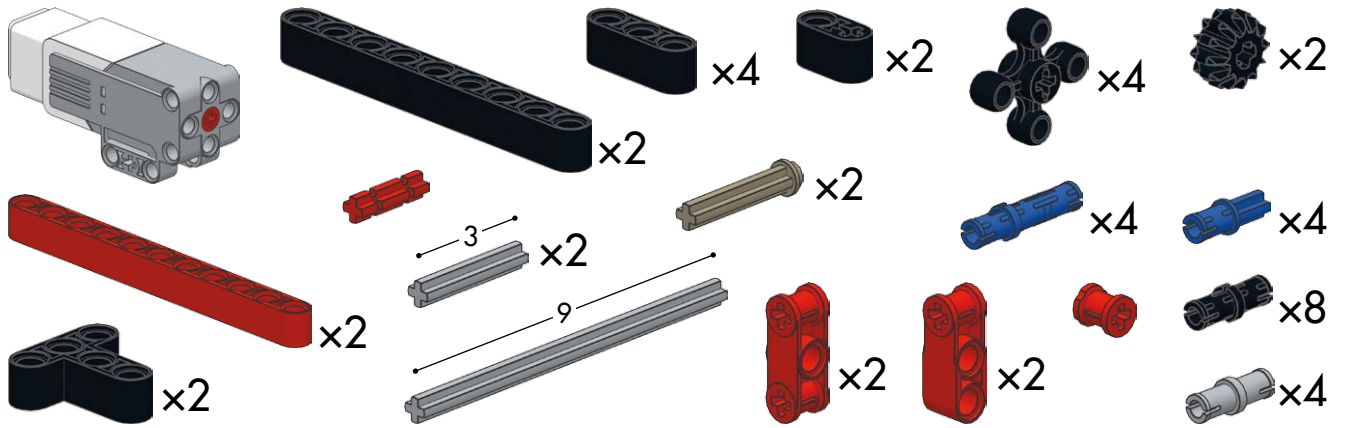

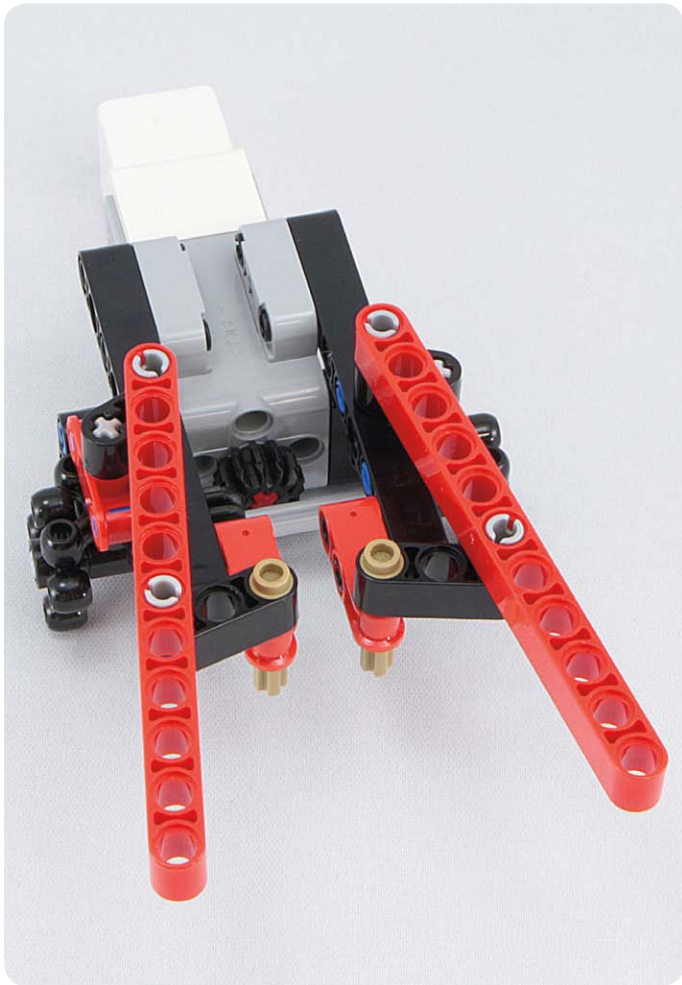
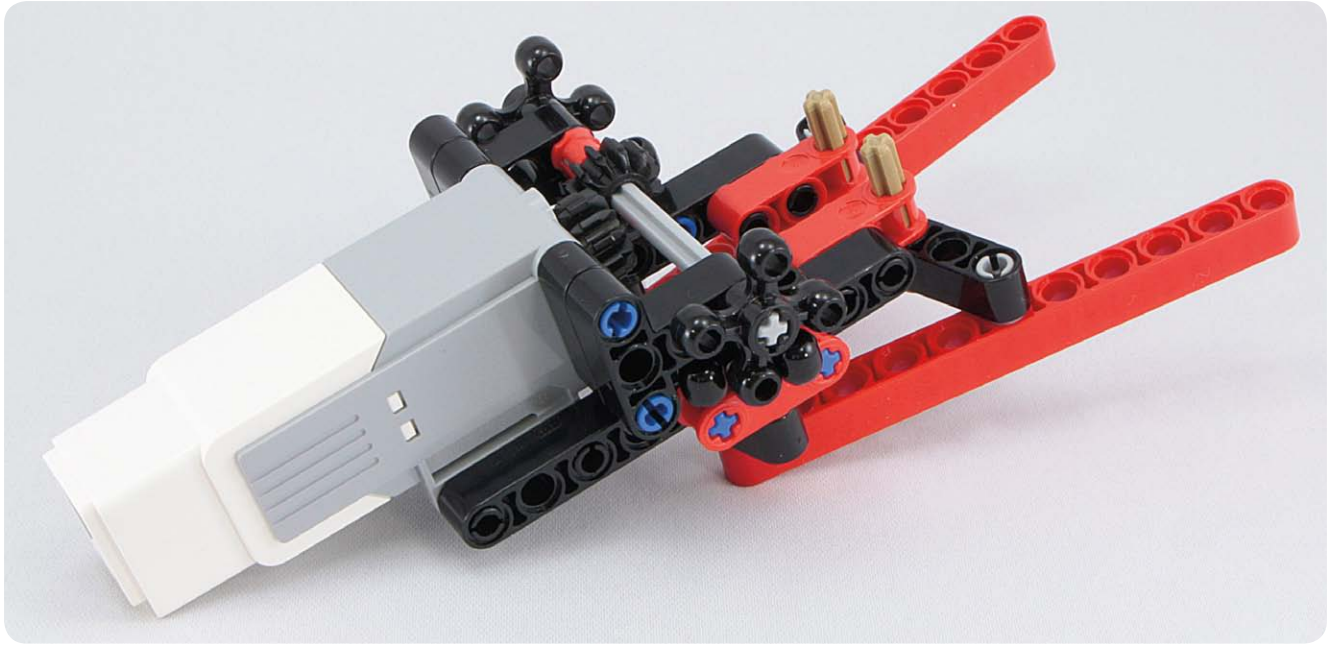



Creating wind

#153

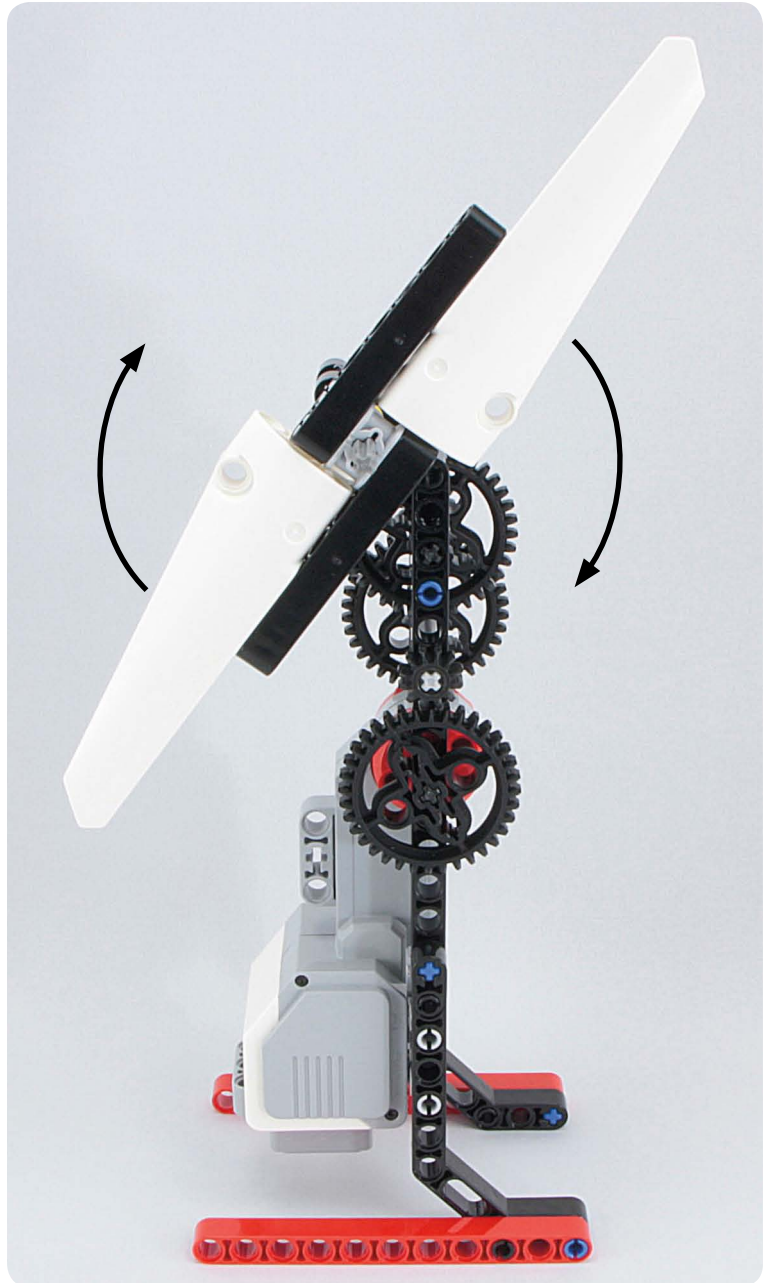

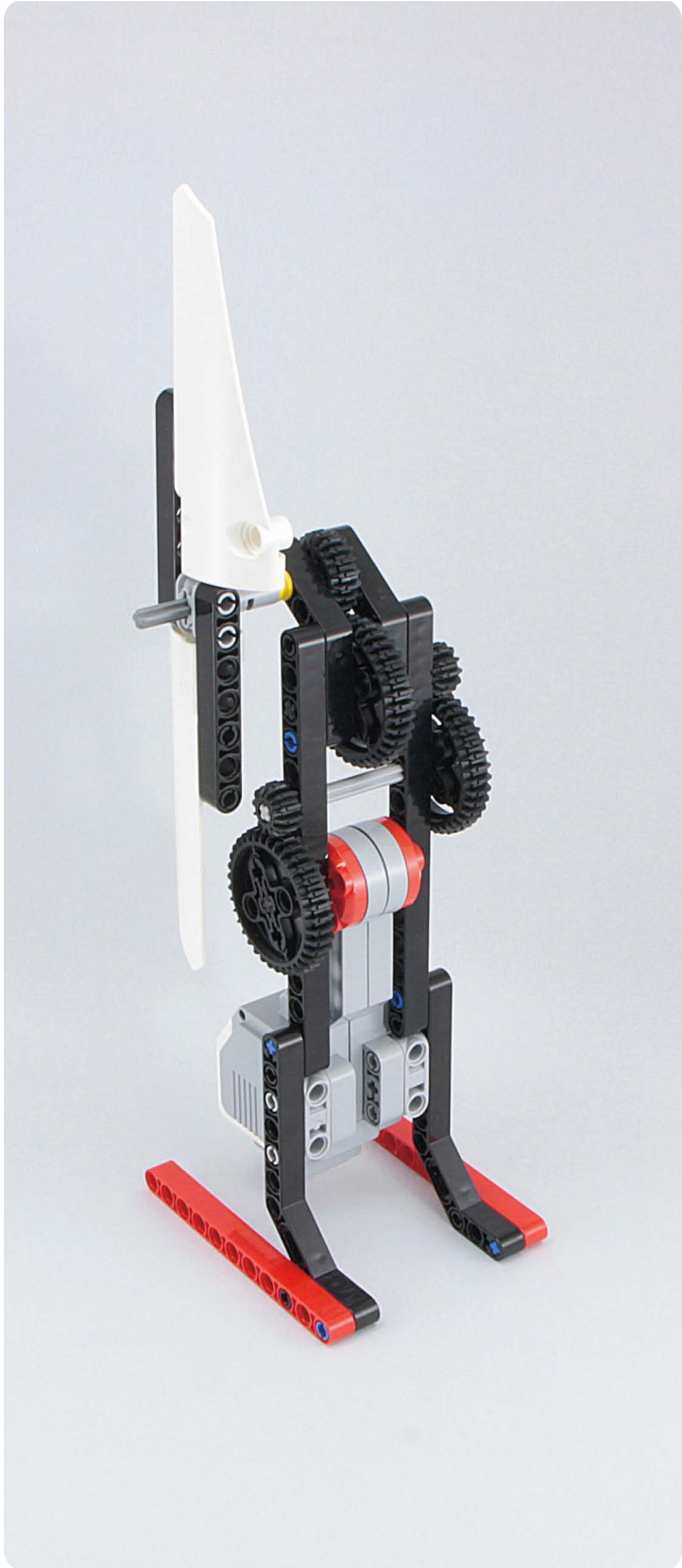

#154

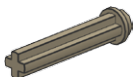
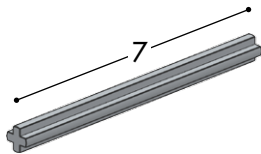
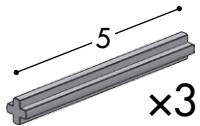
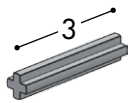
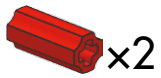
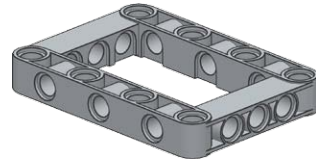
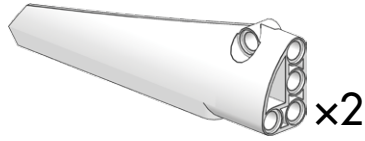
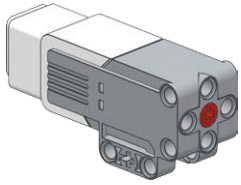

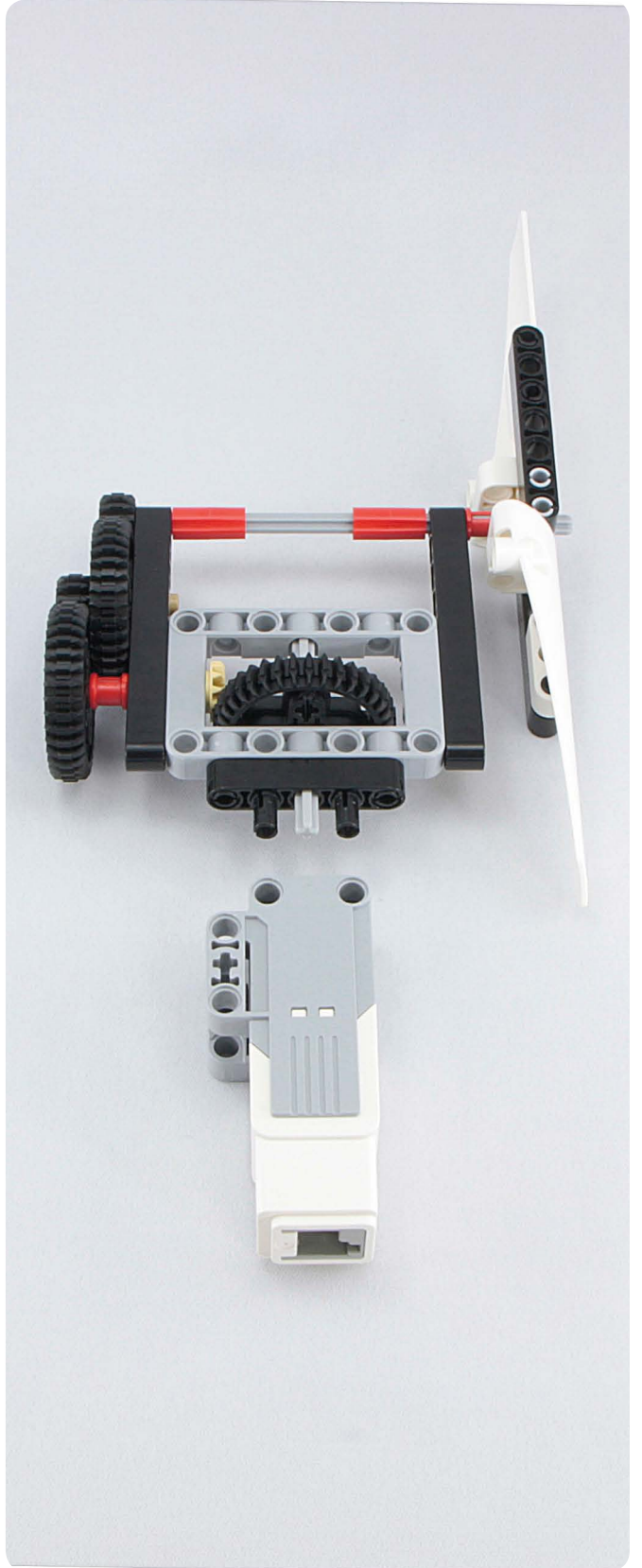
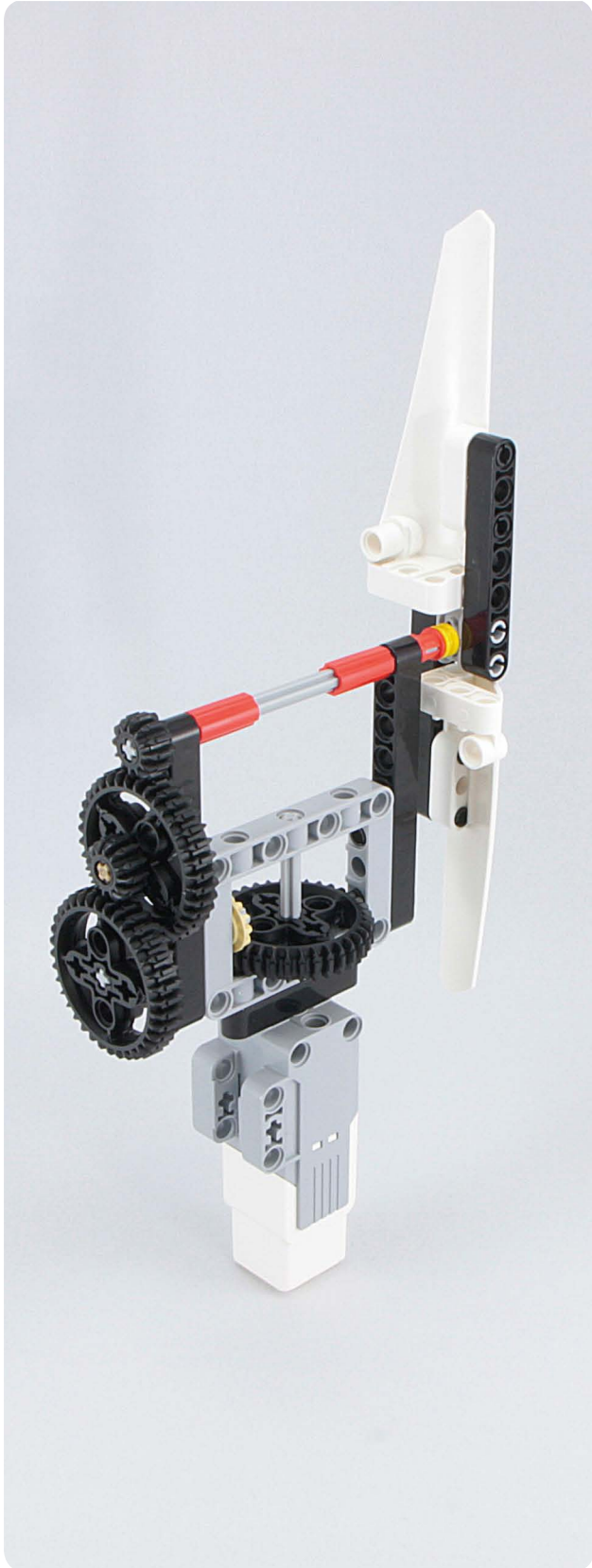

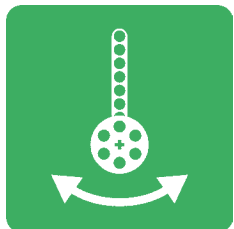

Swinging a pendulum

#155

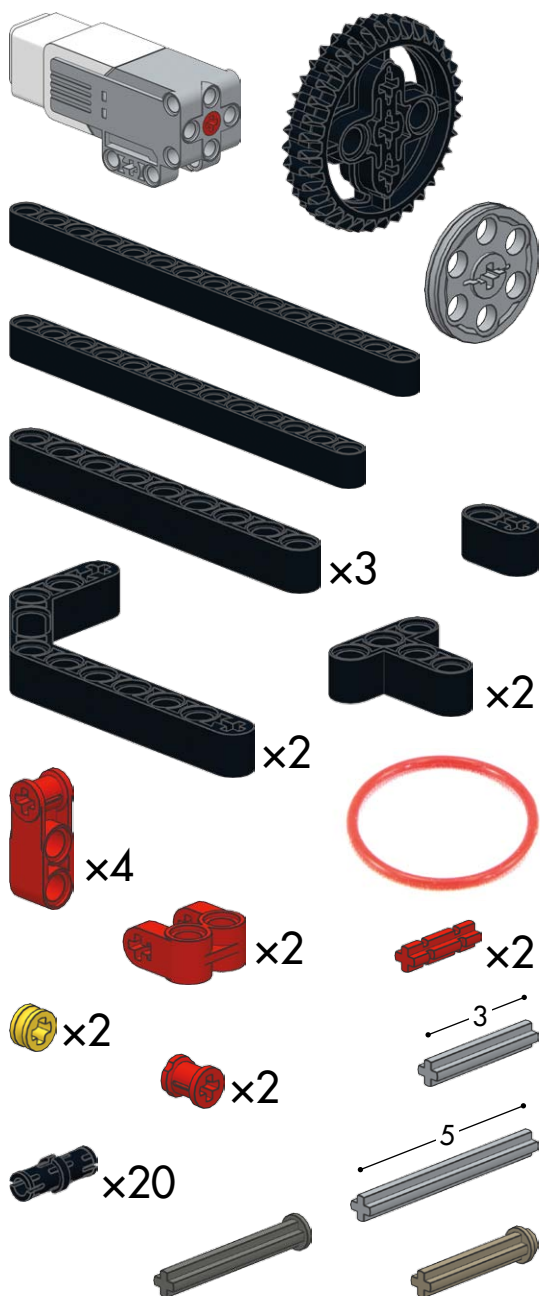

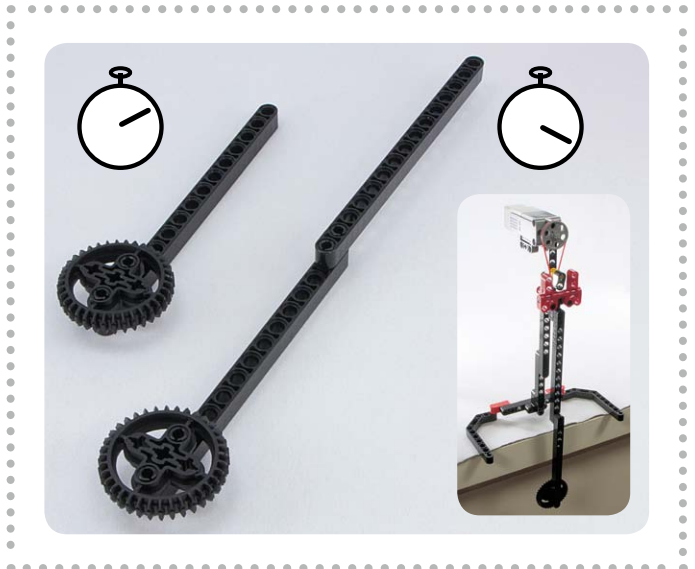
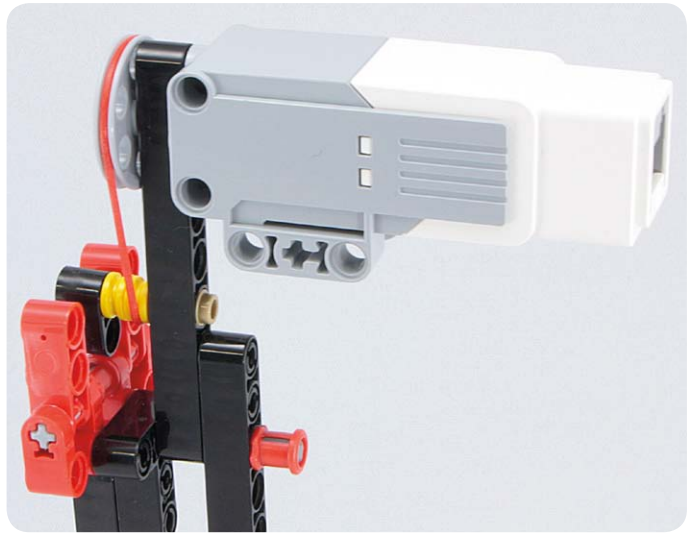

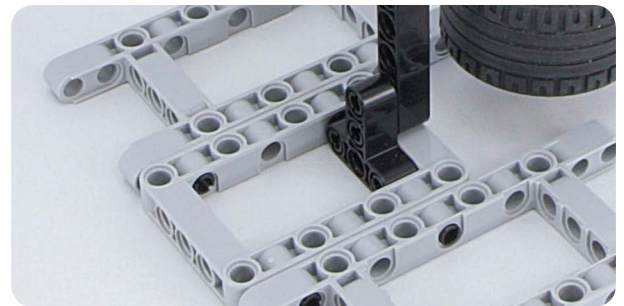
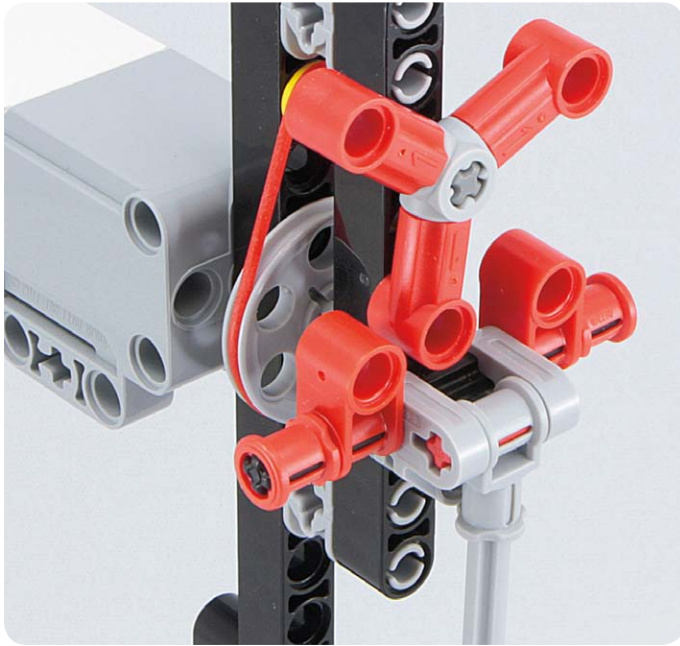
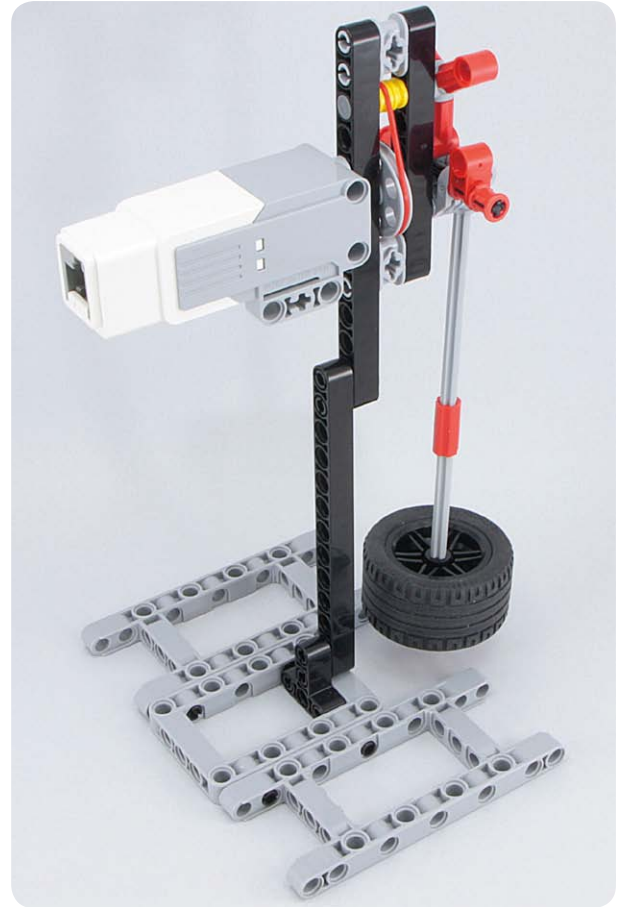
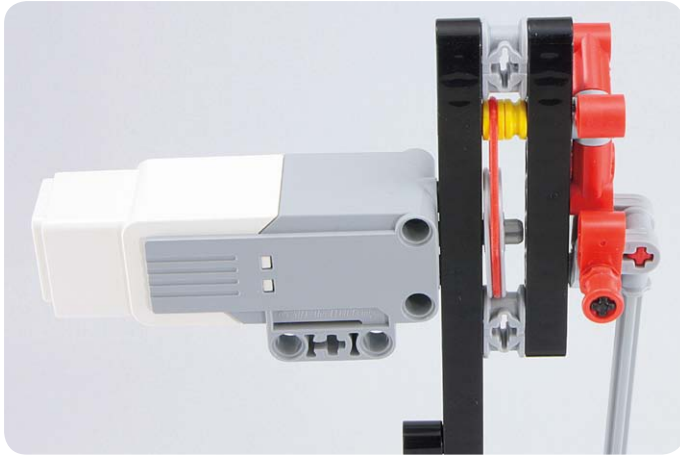

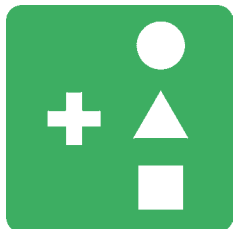





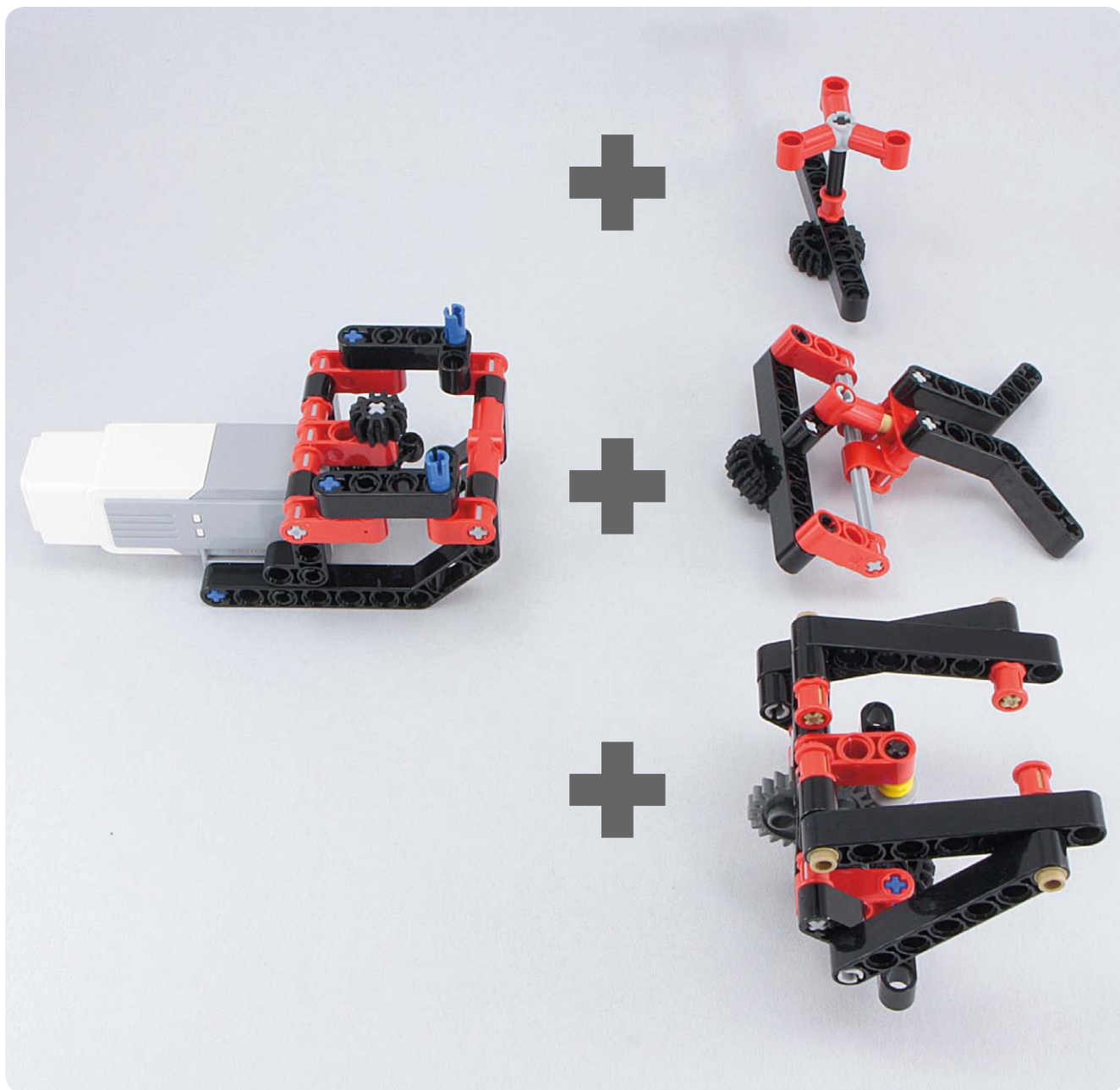

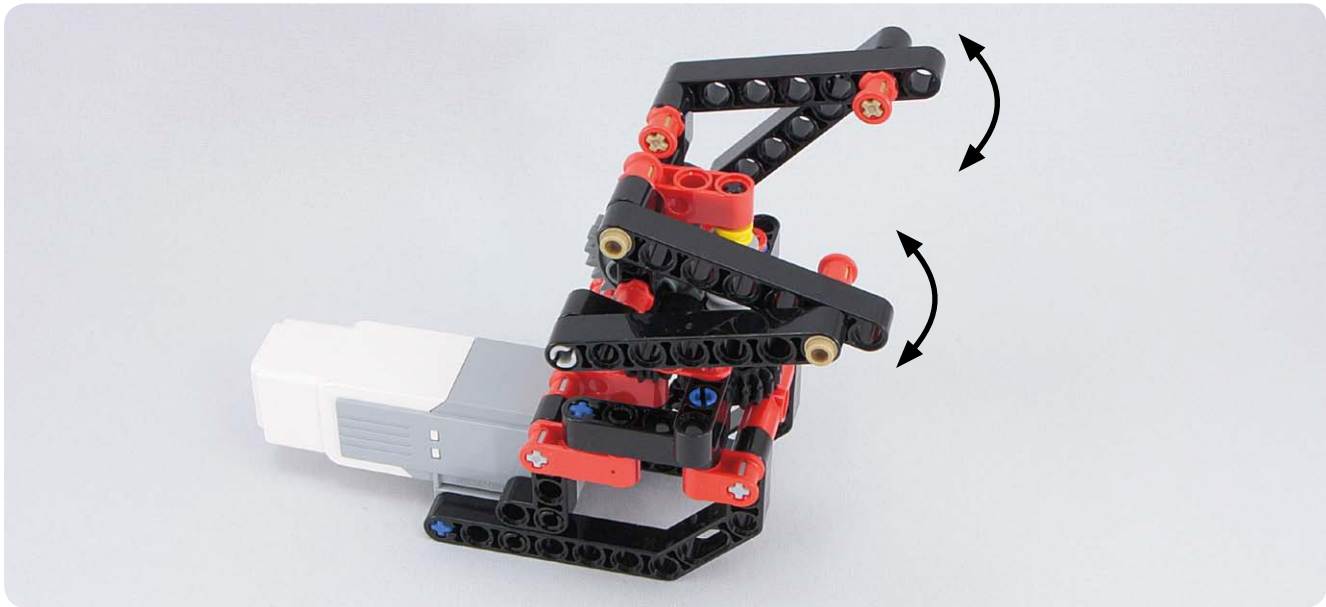
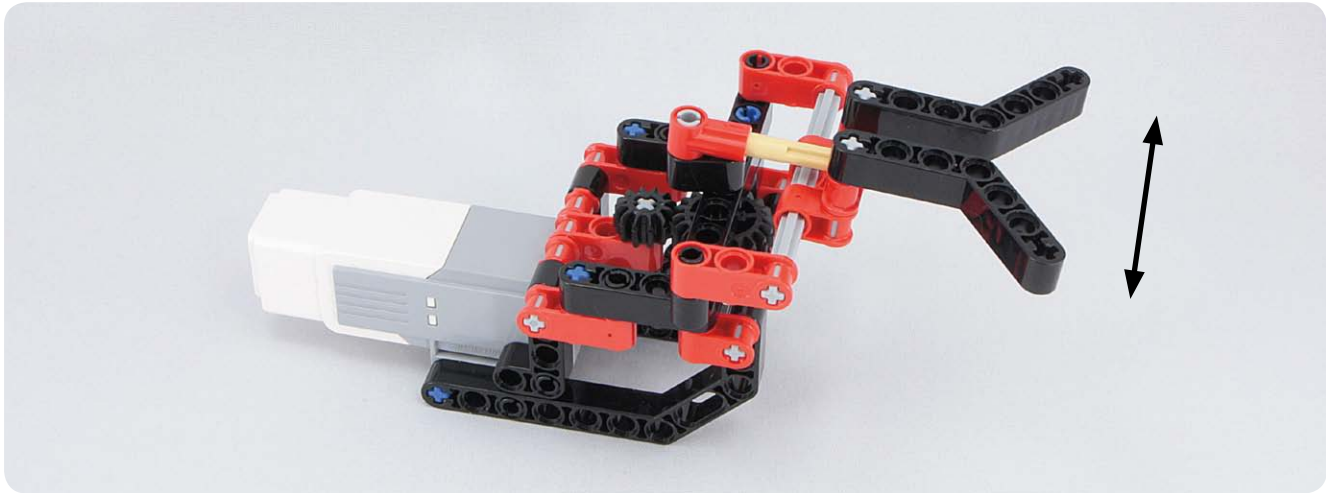
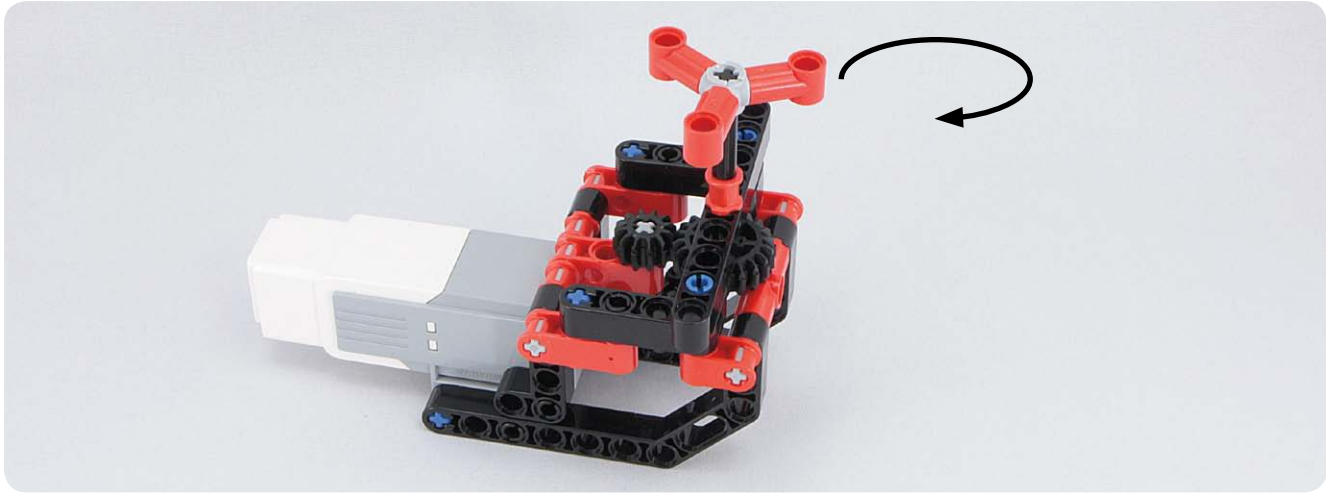

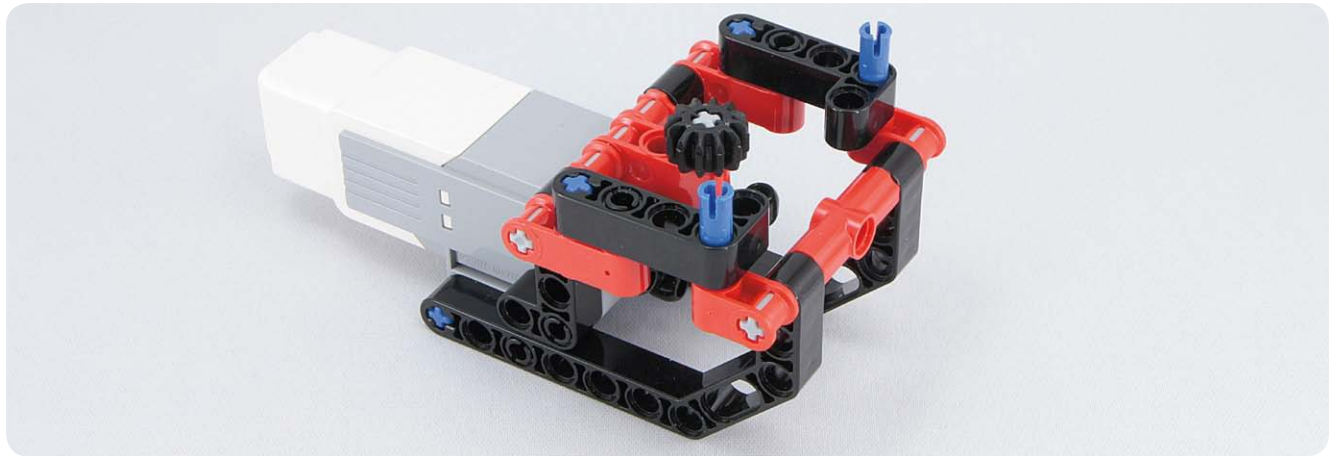

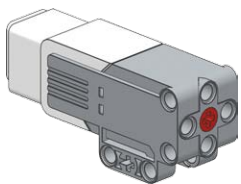

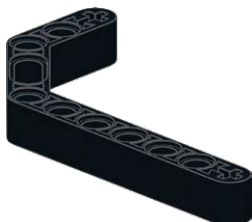
Using attachments to change motion

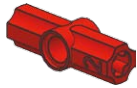
#157



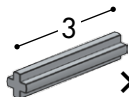

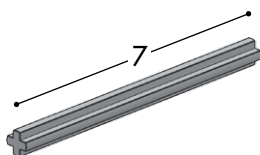



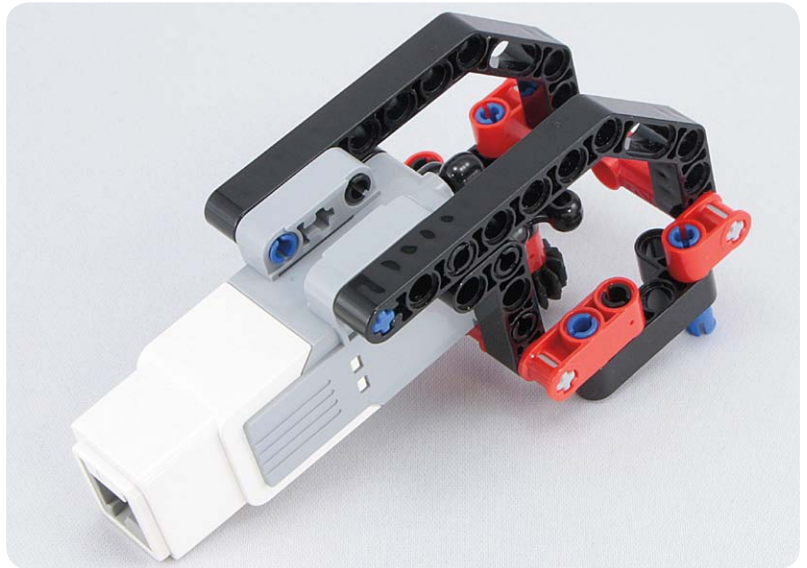

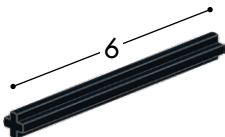
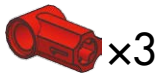

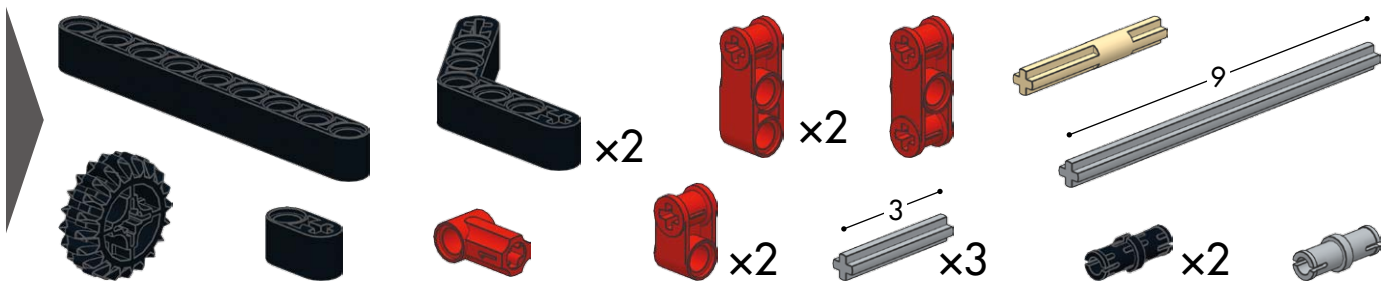

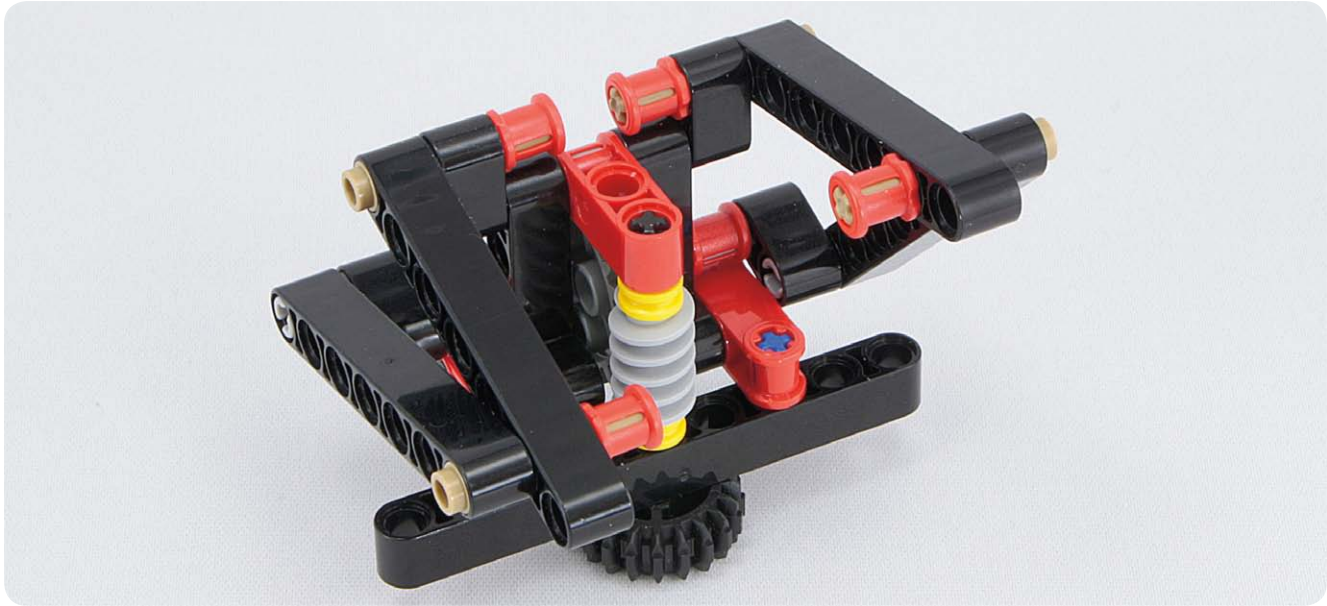







-   x4
-  x2
-  x3
-  x2
- 
-   x2
- 
-  x2
-  x3
-  x4
- 
-  x8
-  x2

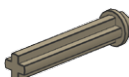

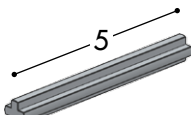

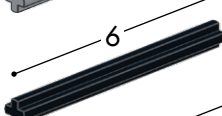

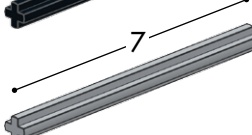

-   x4
-  x4 
-  x2 
-  x3 
-  x4  x2
-   x2
-   x4
-   x6
-  x2

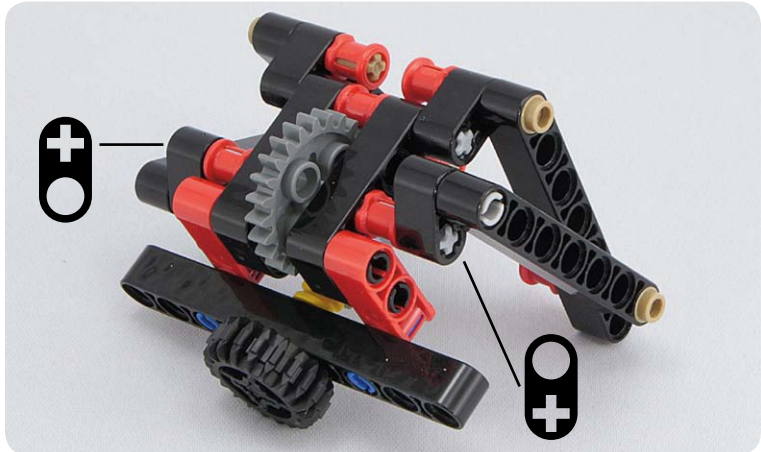

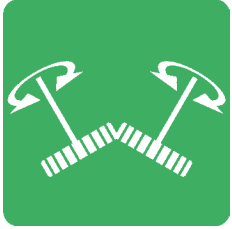

Meshing gears diagonally

#158

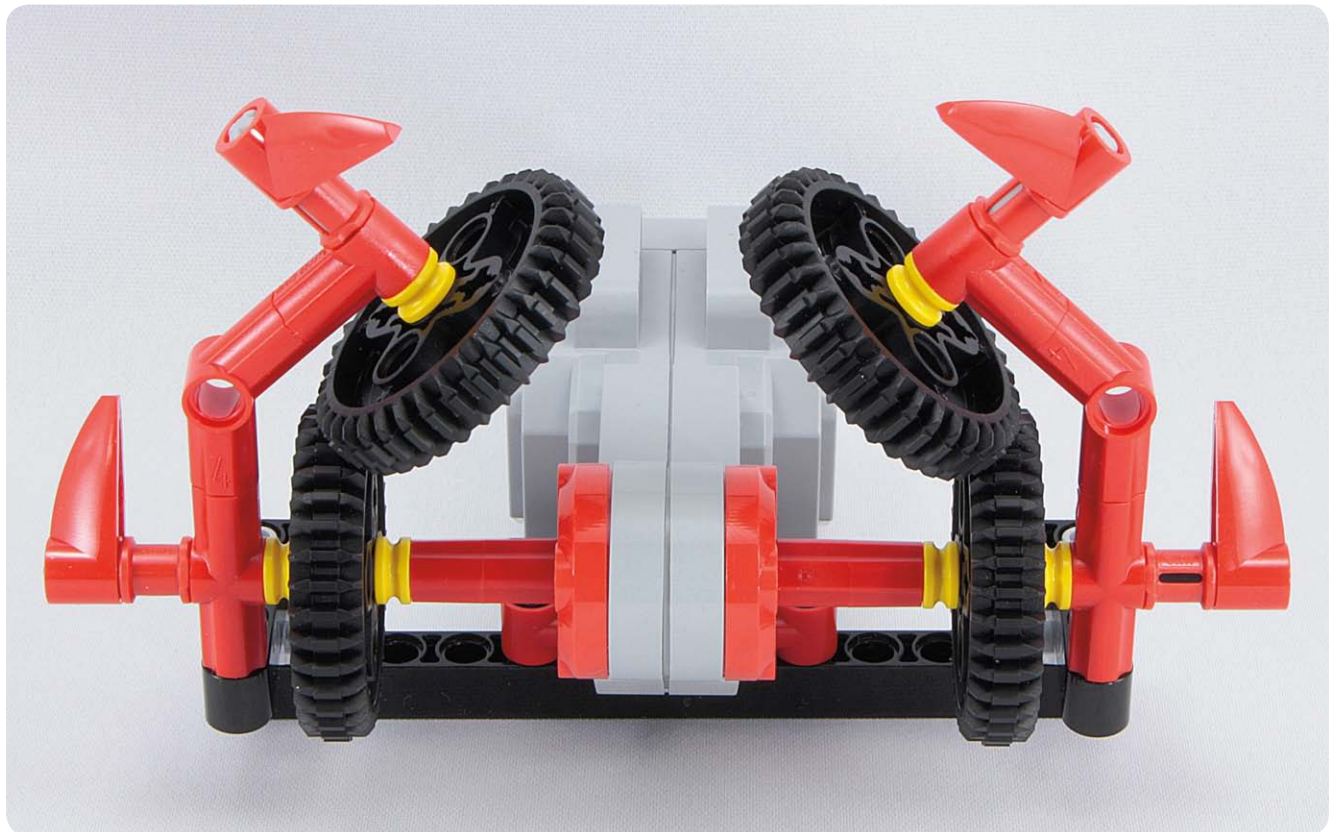
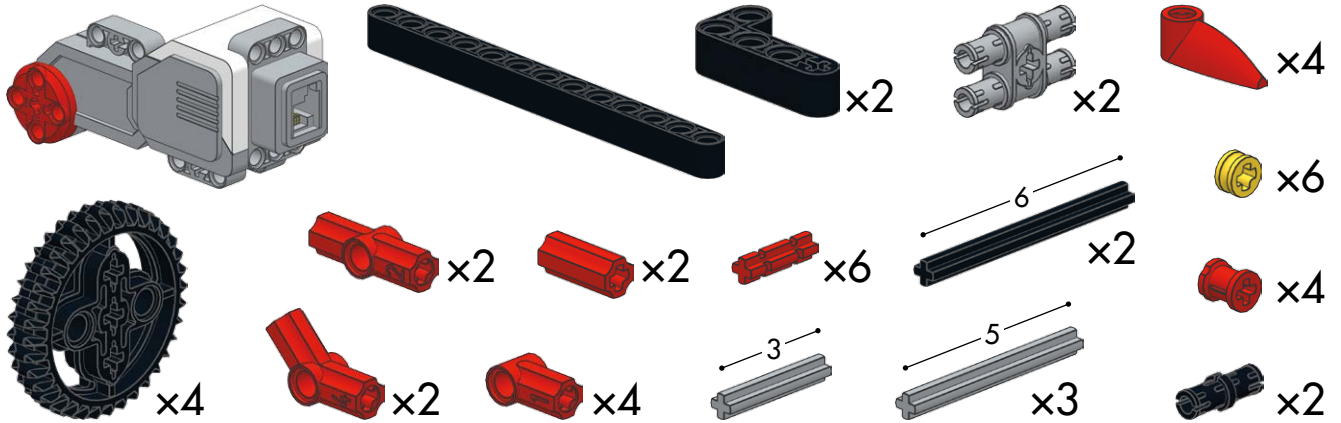

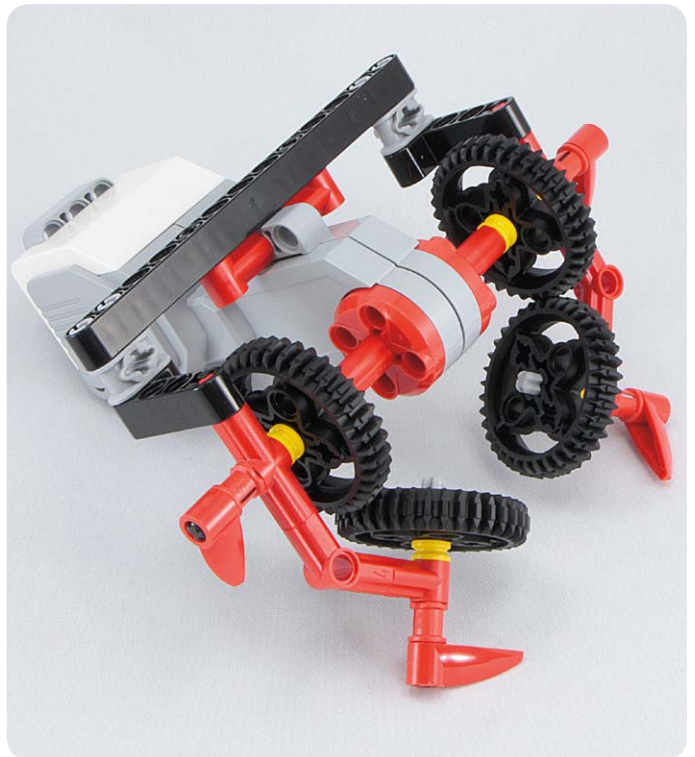

#159

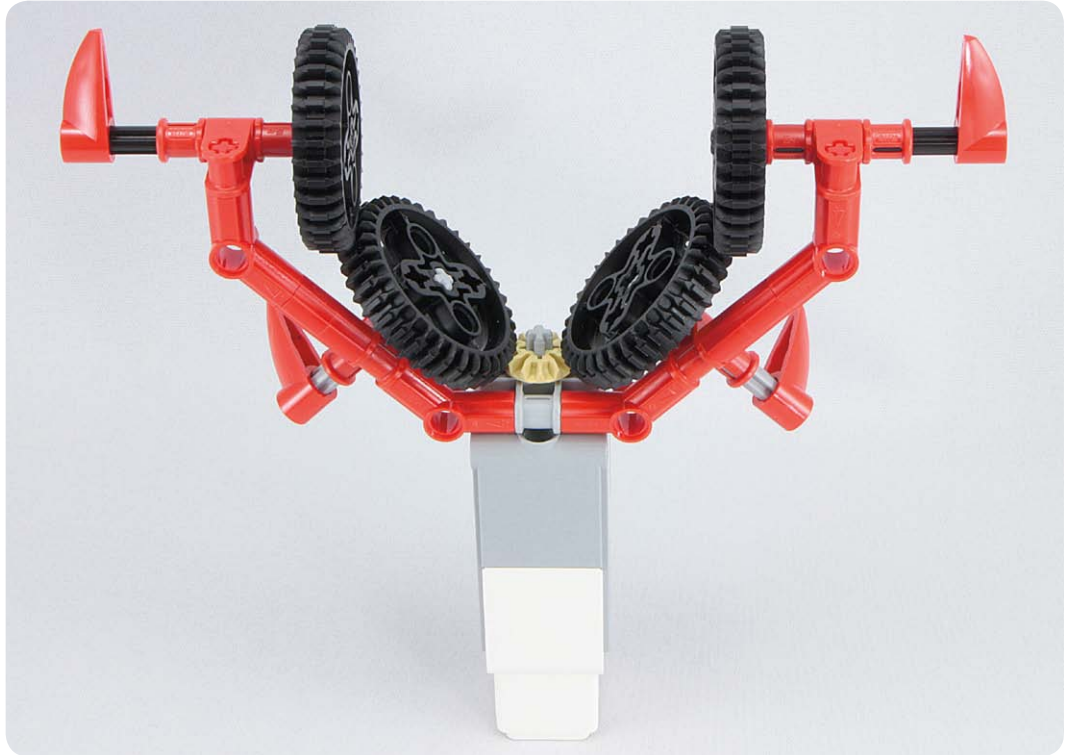
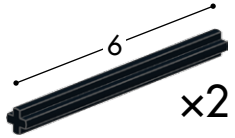
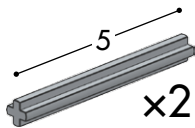
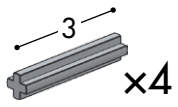
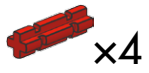
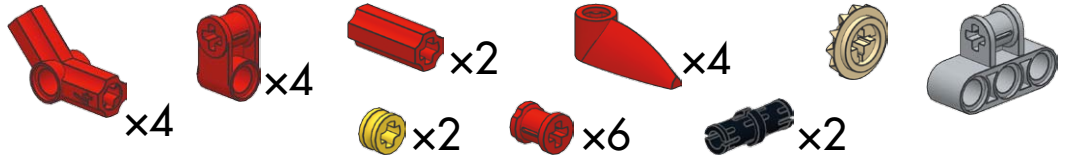
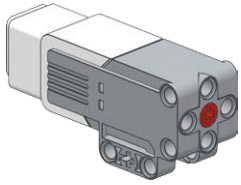

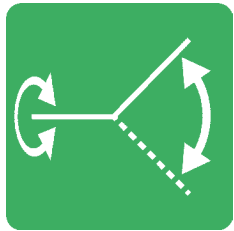

Changing the angle of rotation freely

#161

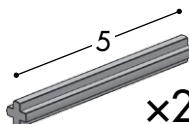
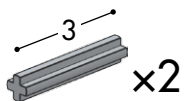
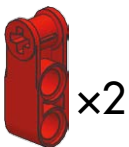
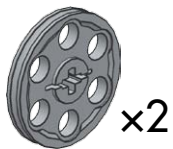
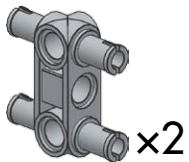
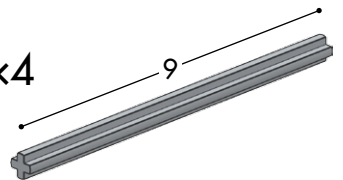
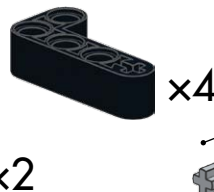
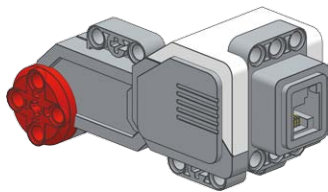



#162

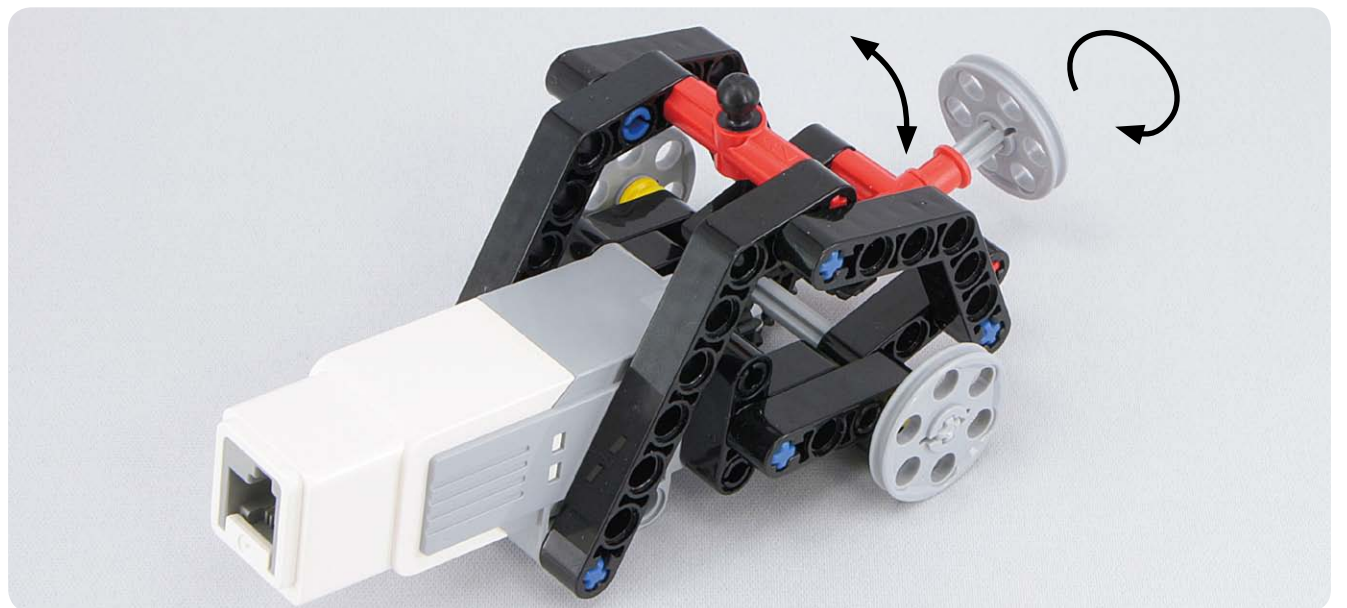
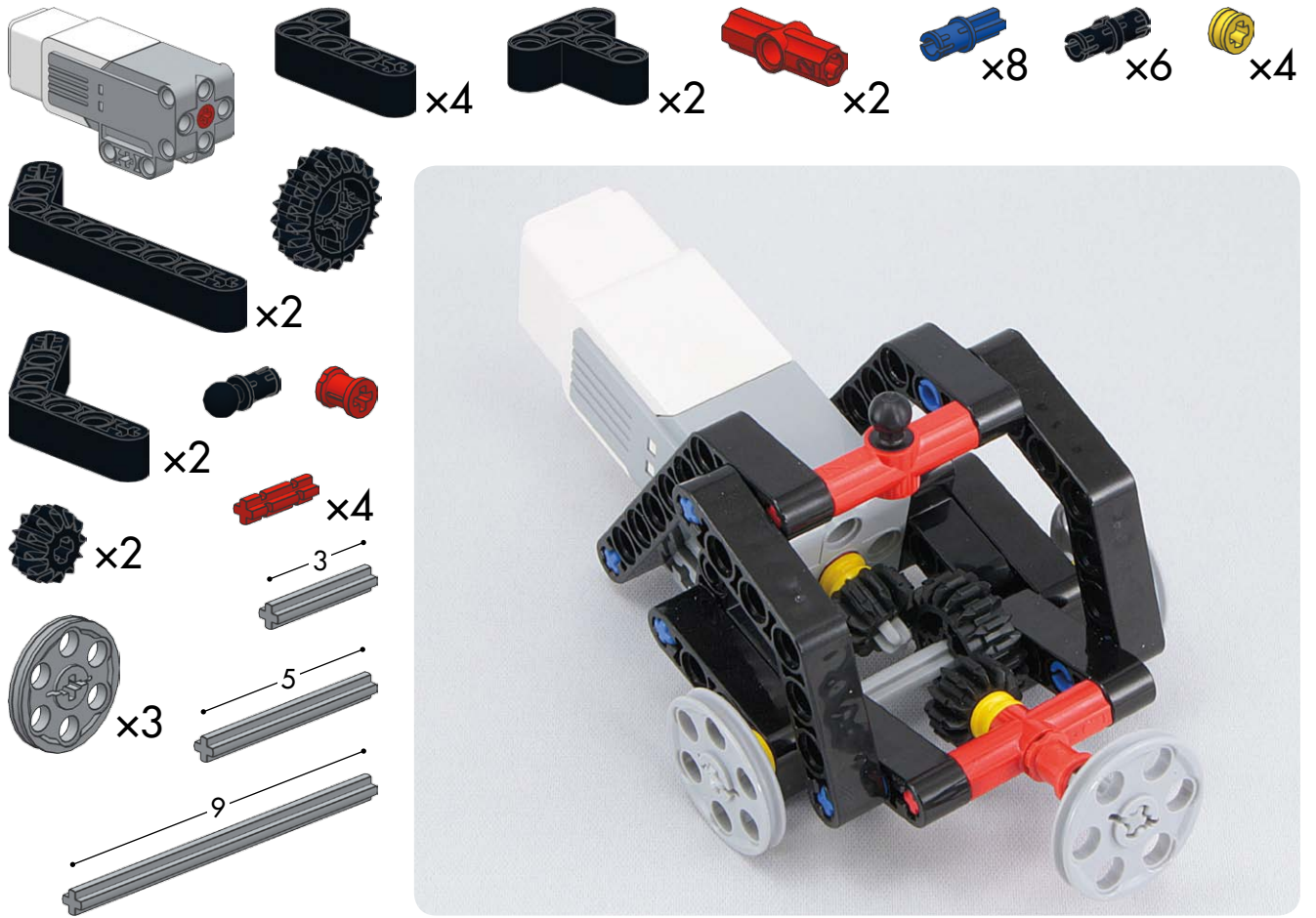

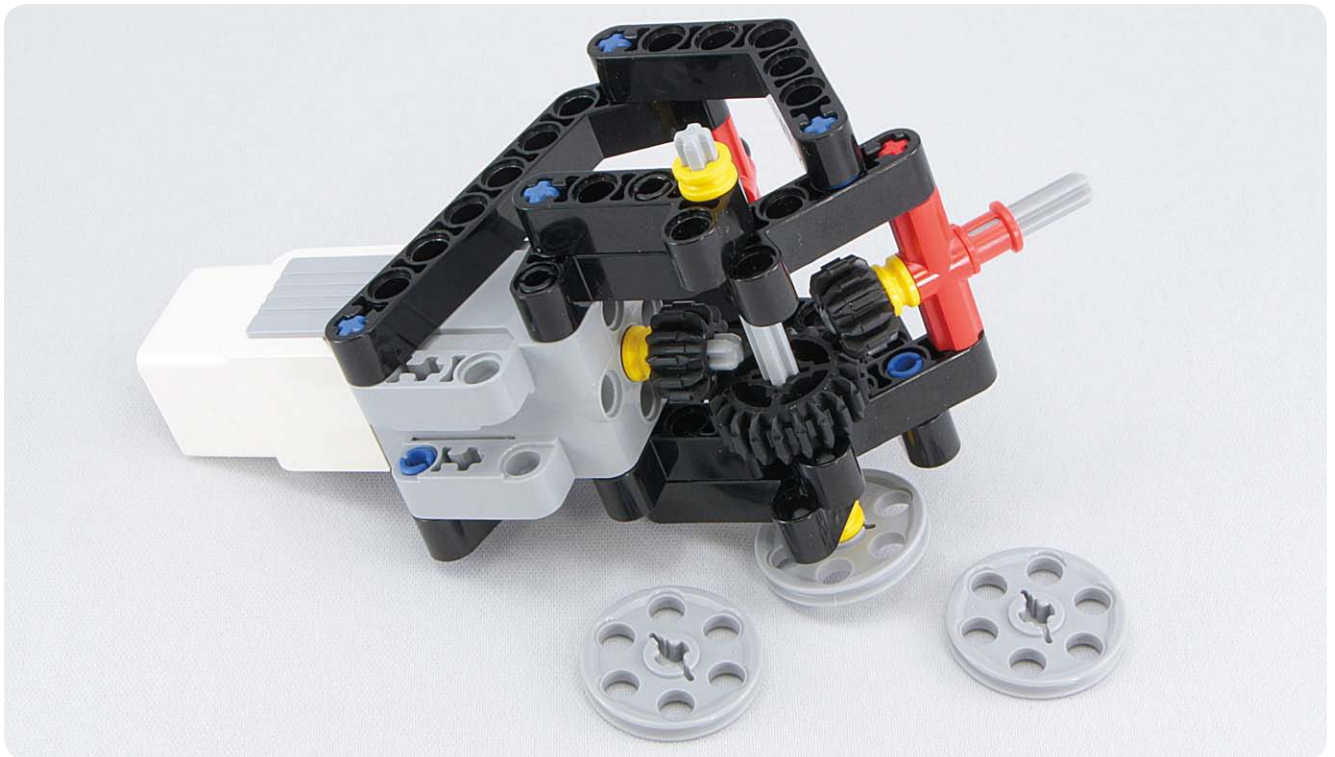

#163

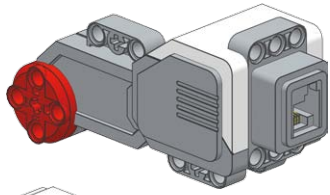

x2



x2



x2



x2

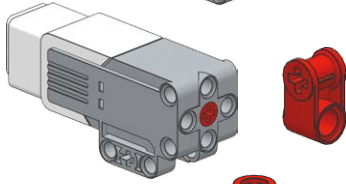

x3



x2



x8



x4

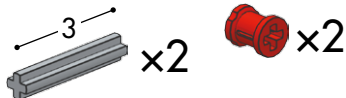

x2

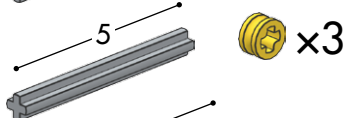

x3

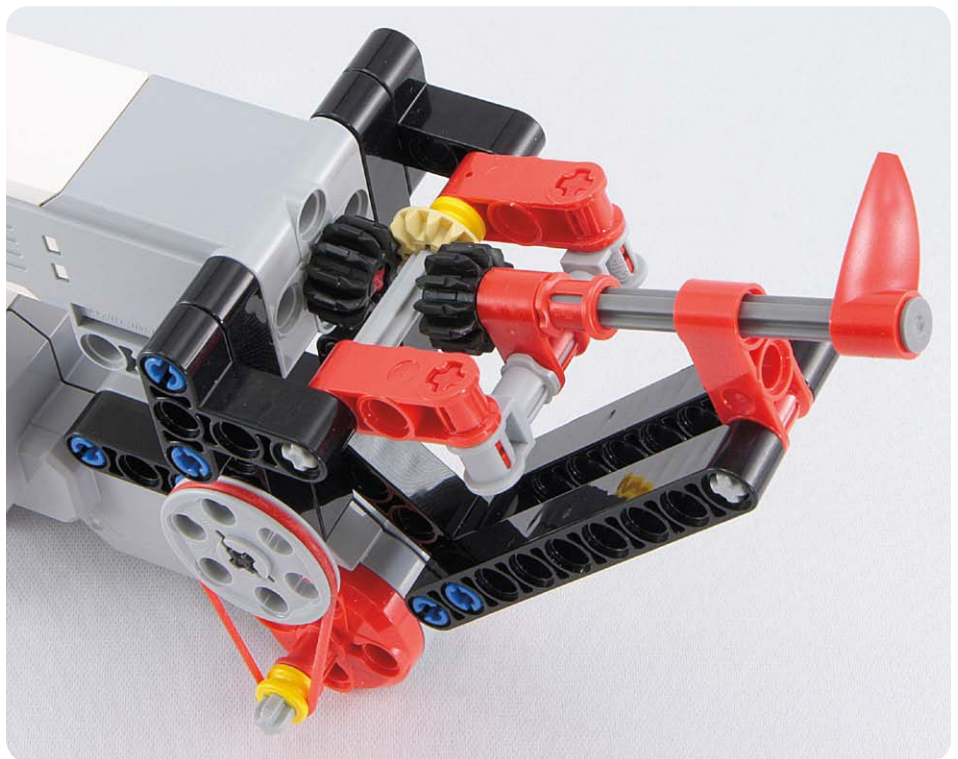
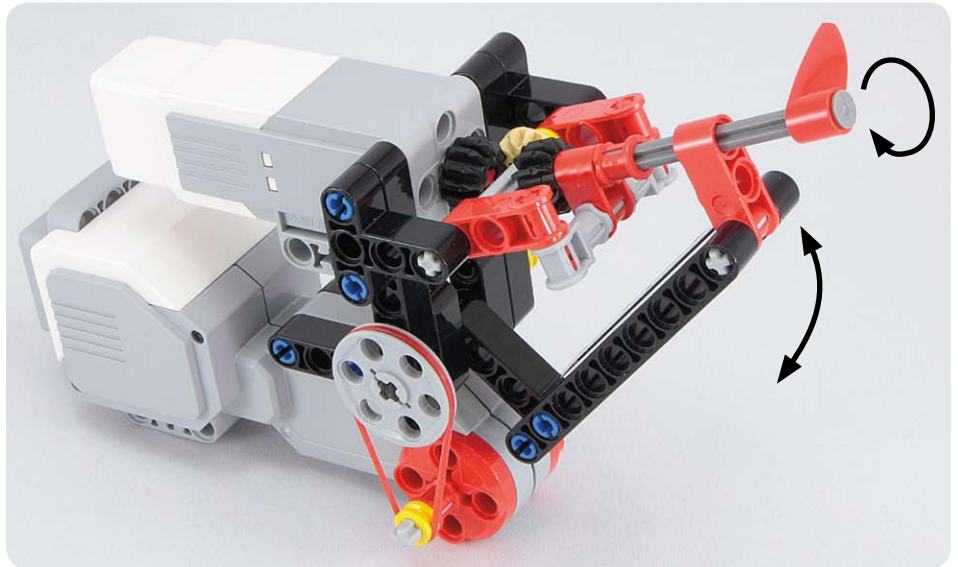

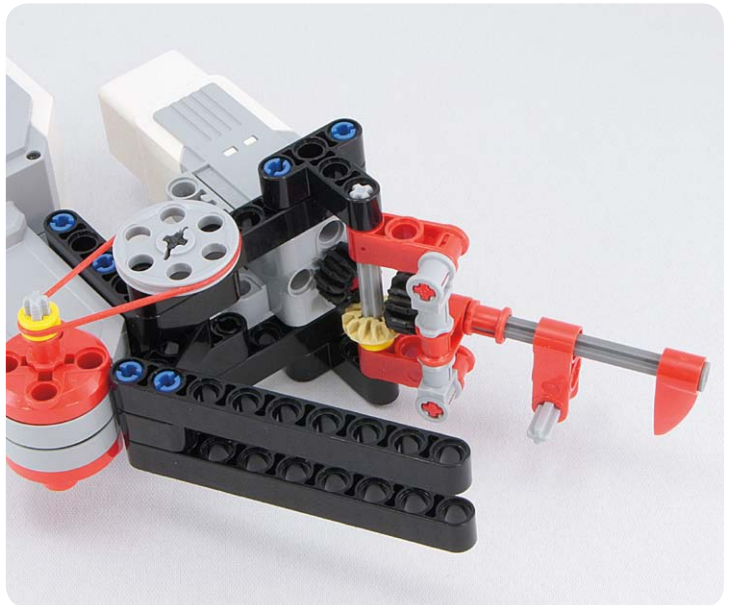
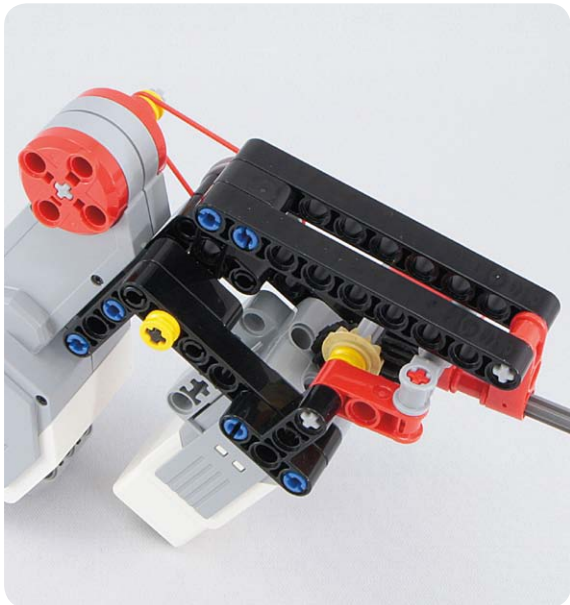
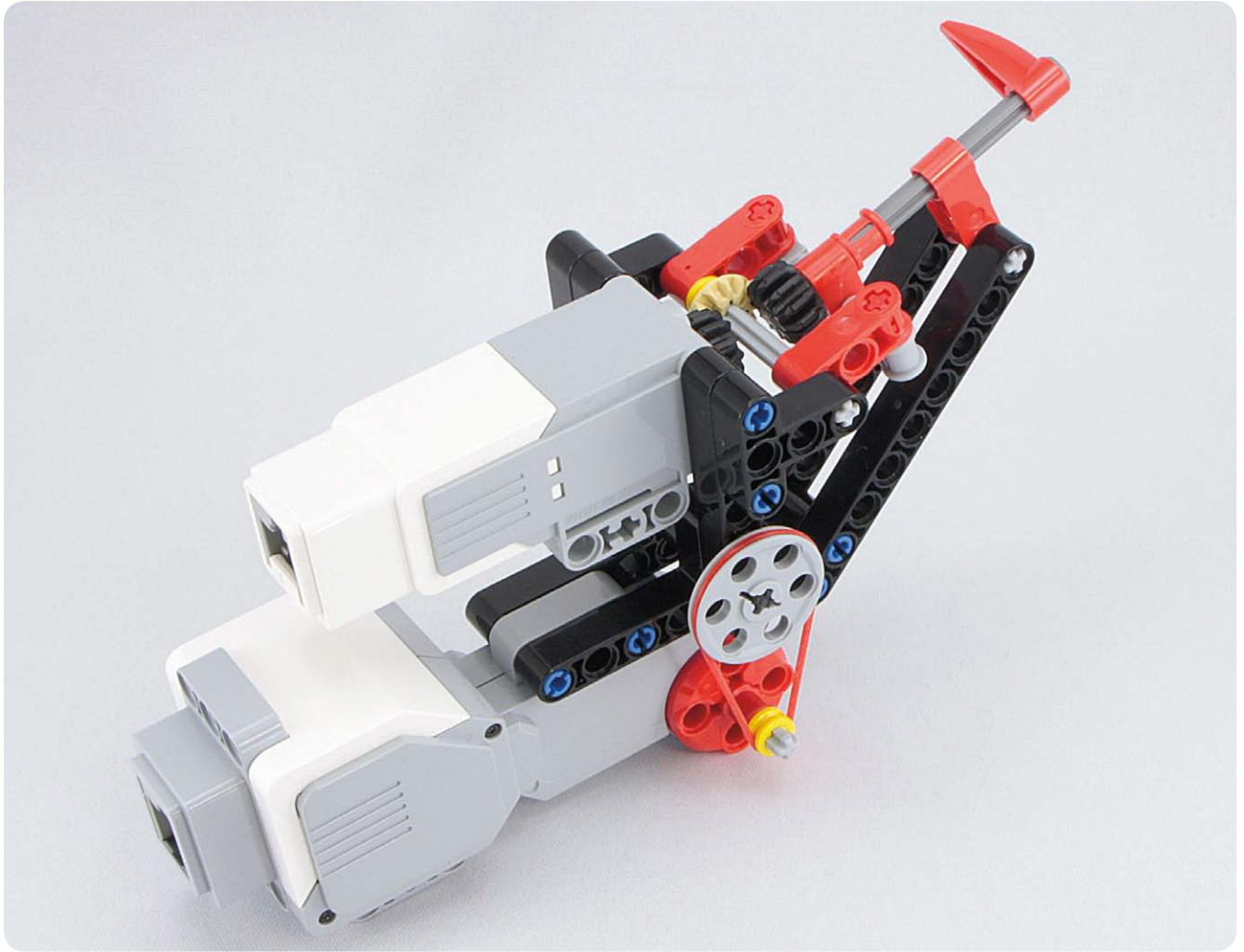

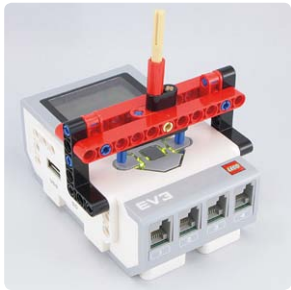

PART 5

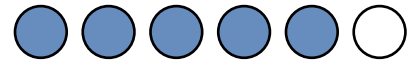

Sensors



206

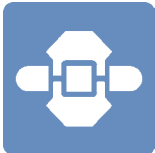

214



216

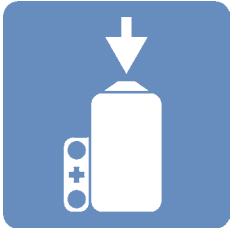

Ideas for using the touch sensor

#164

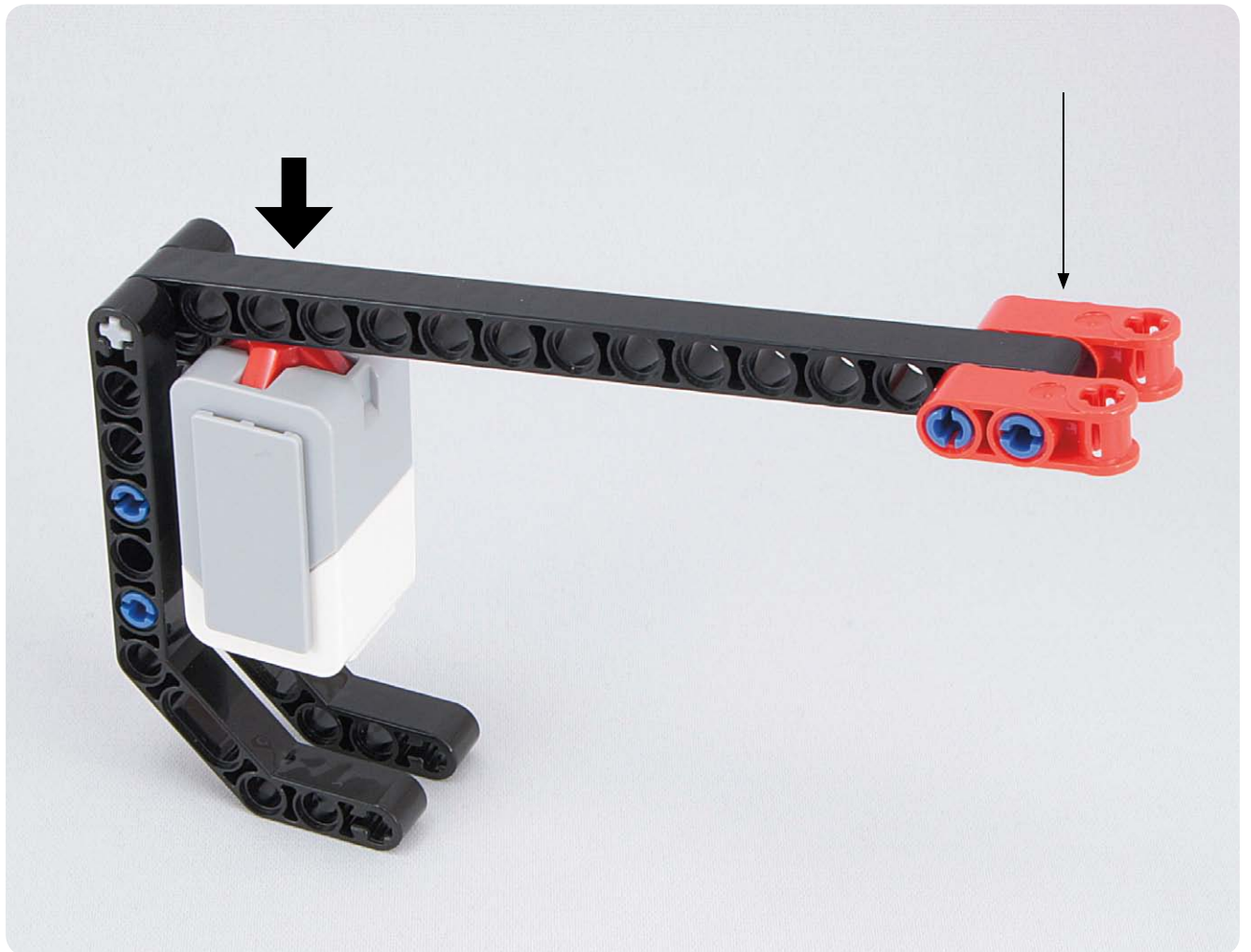
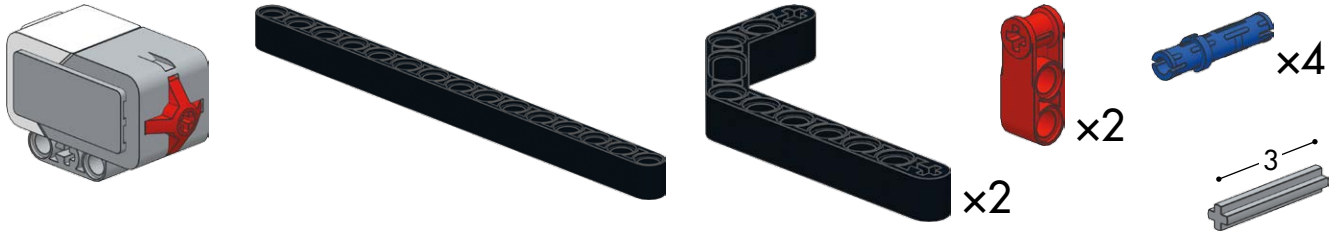

#165

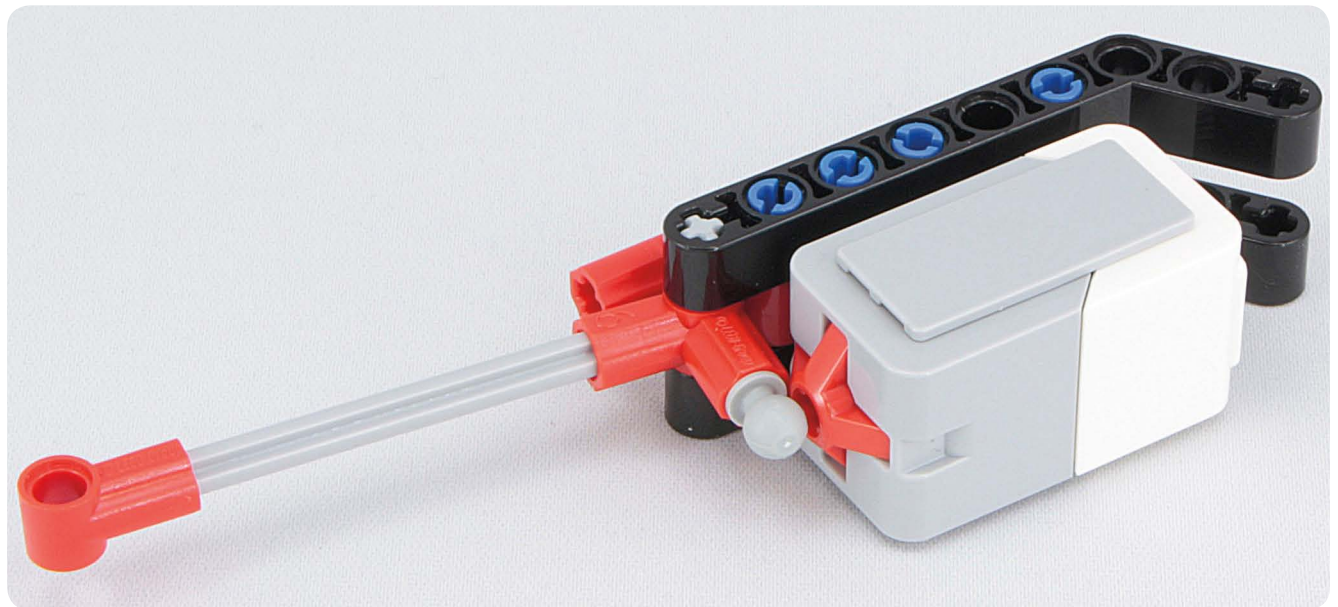
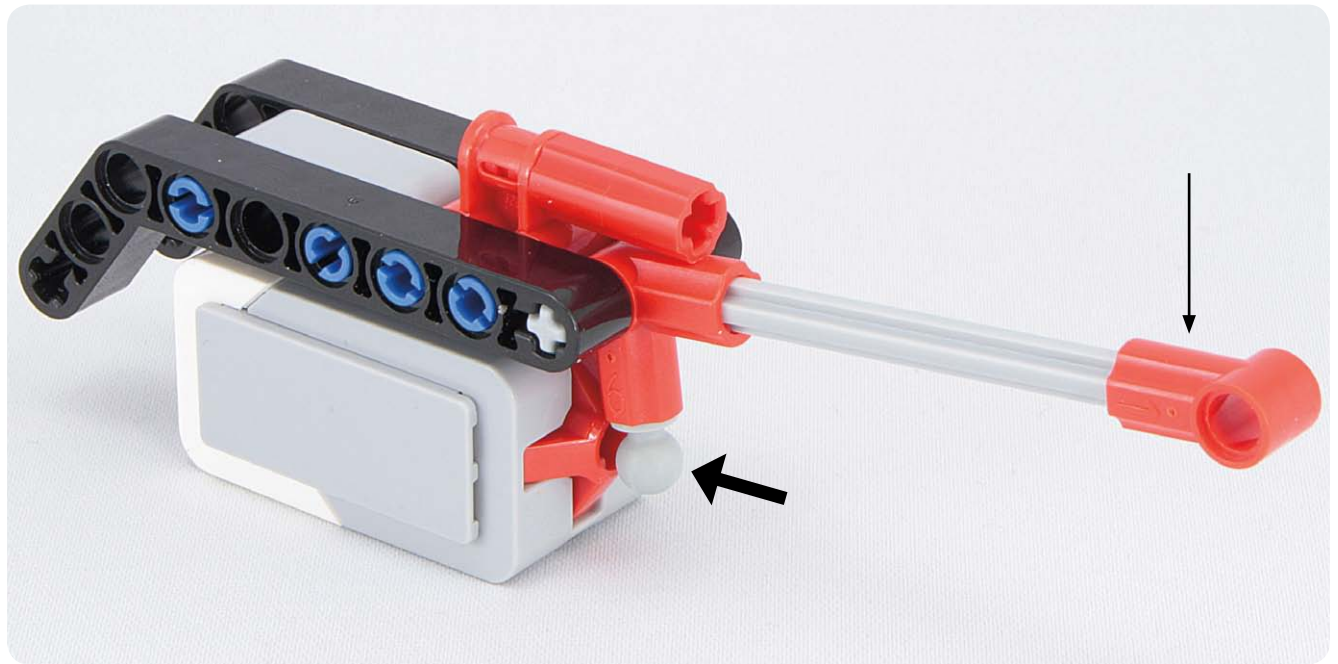
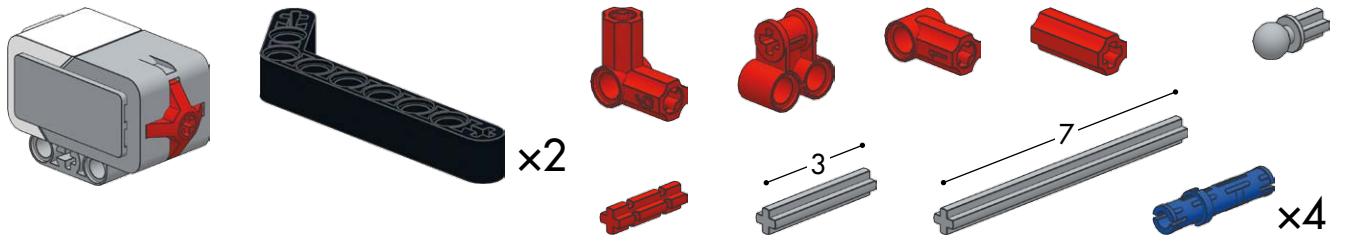

#166

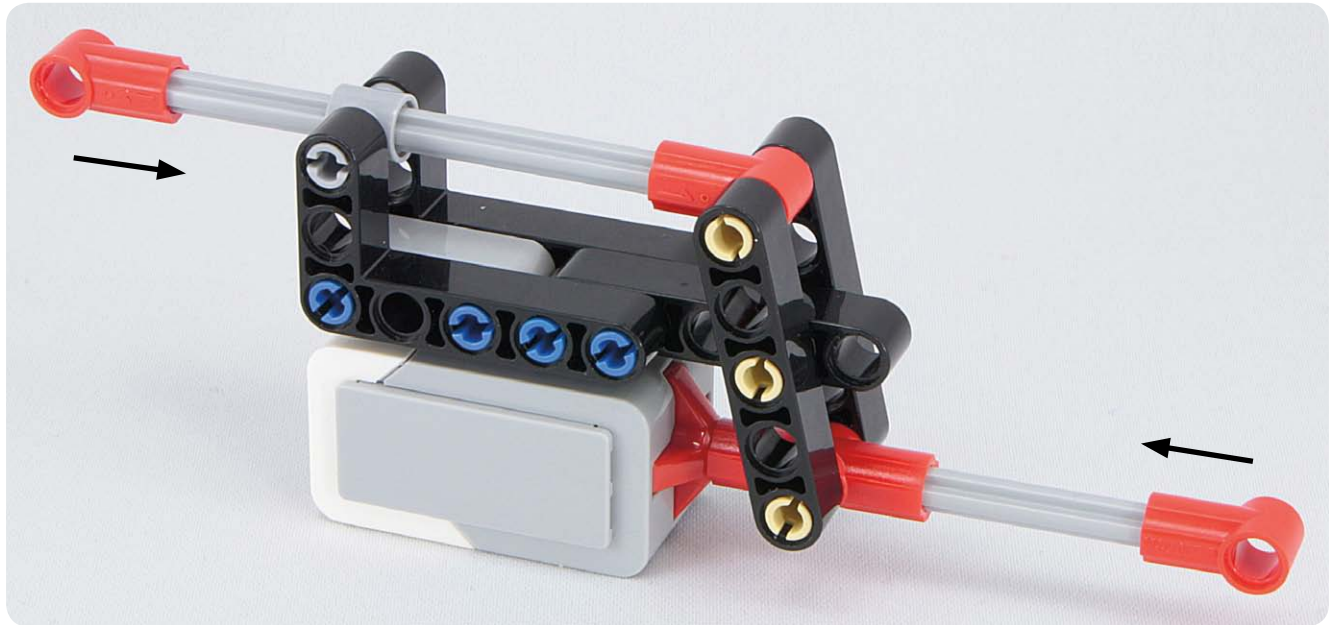
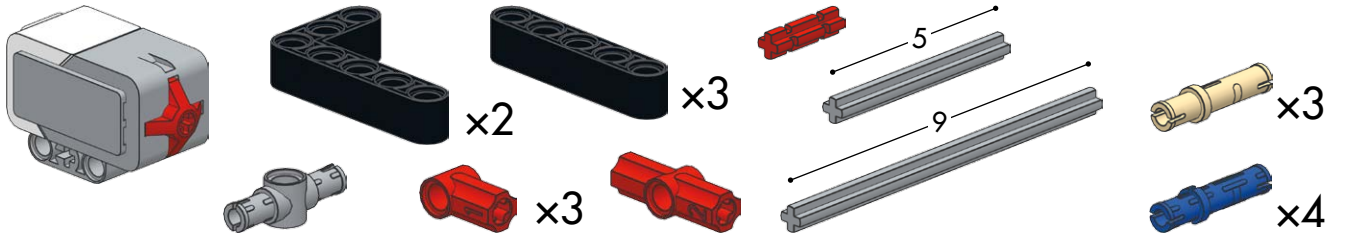

#167

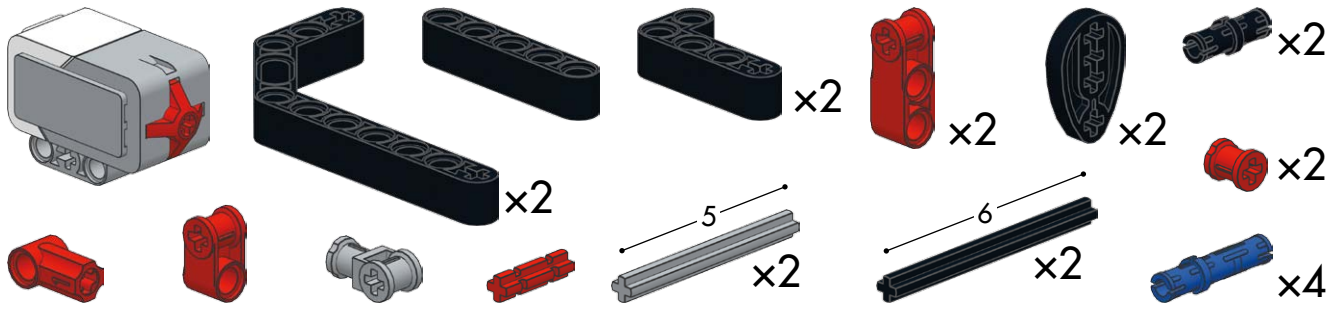

#168

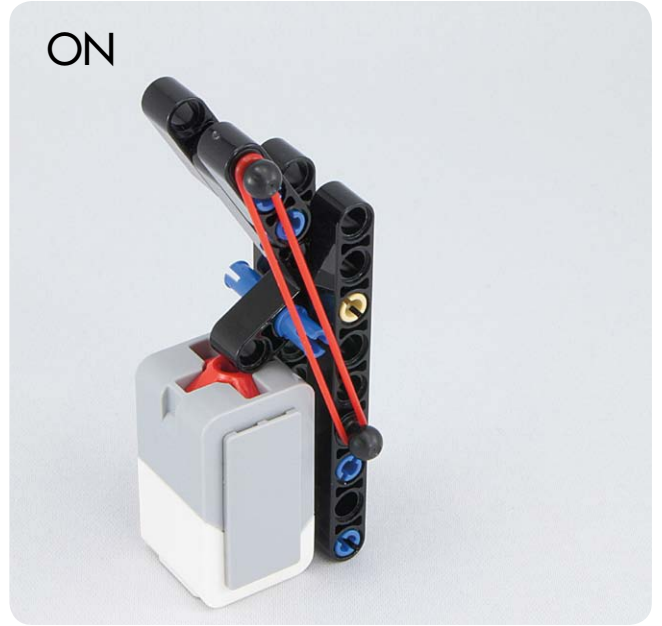
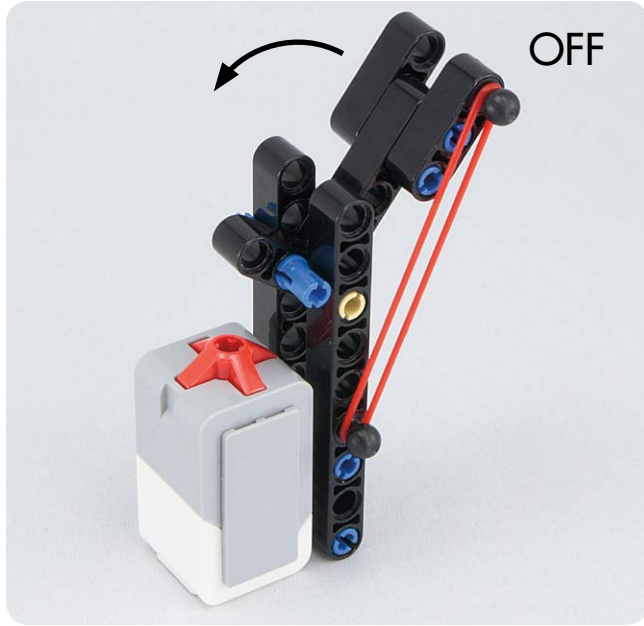
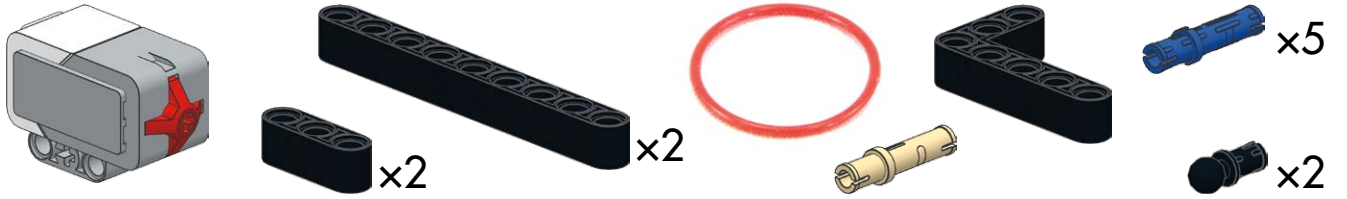

#170

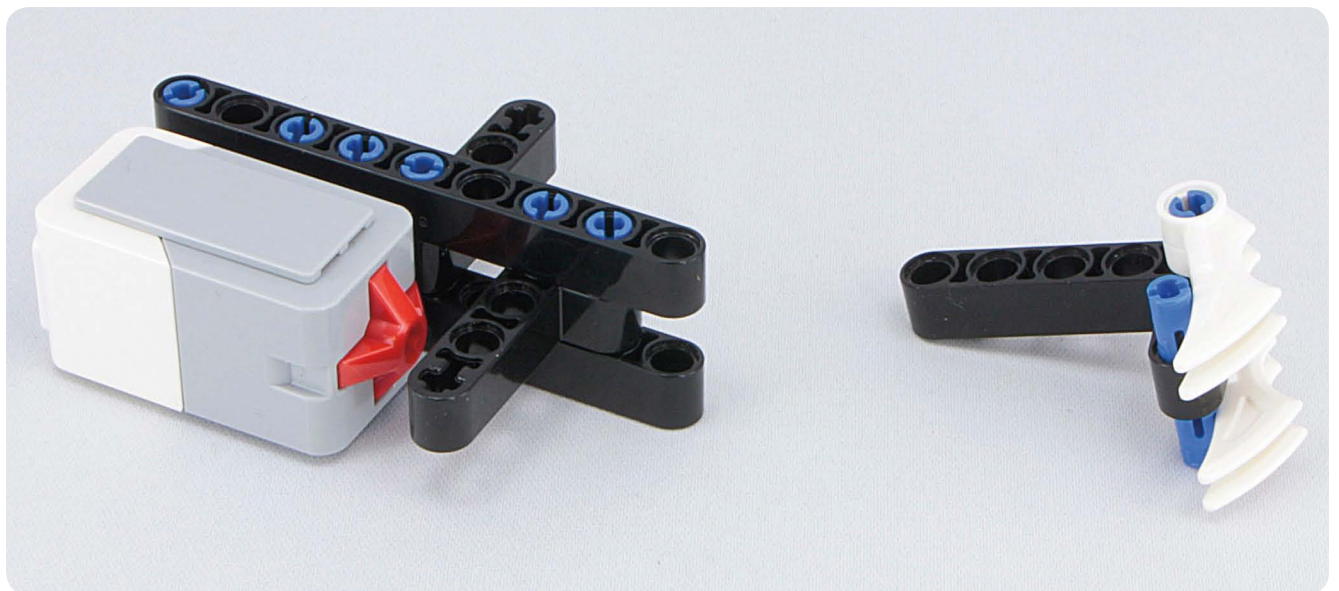
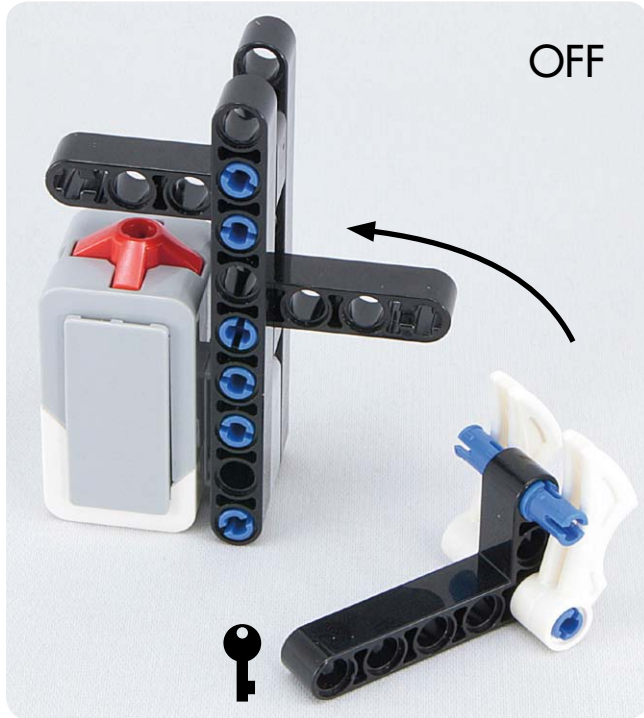
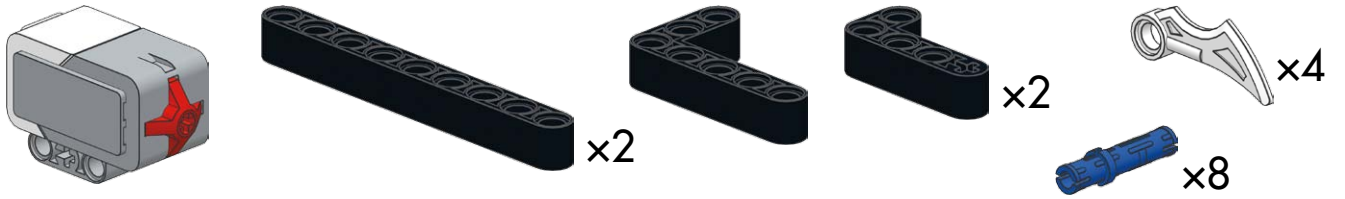

#171

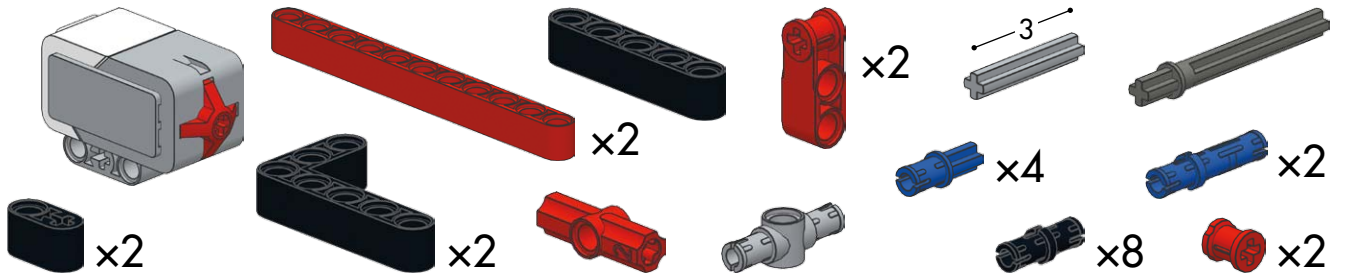

#173

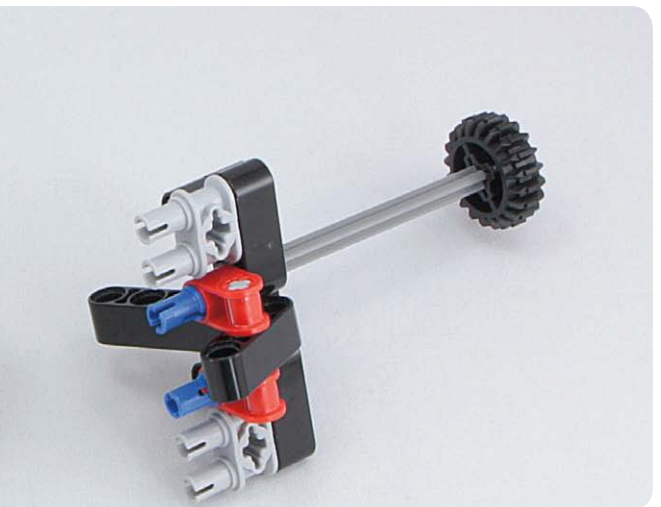
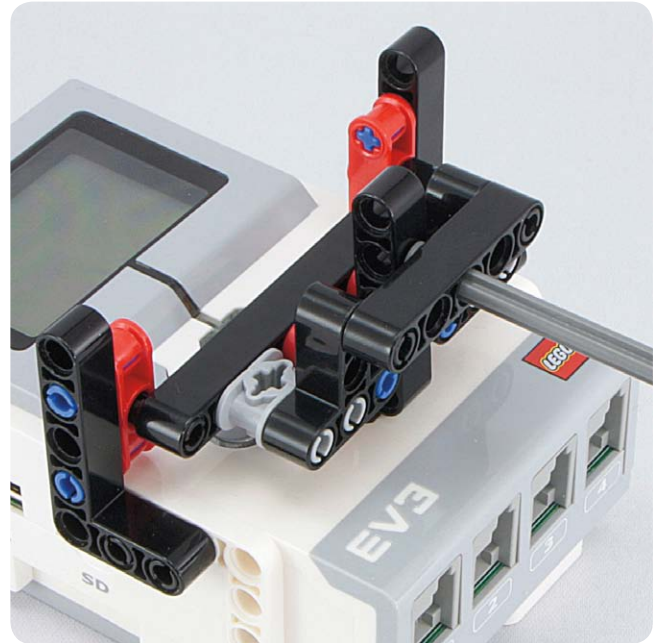
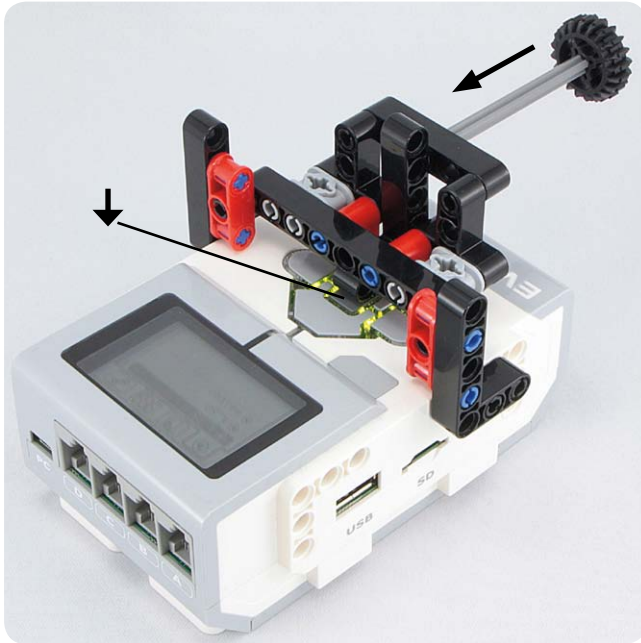
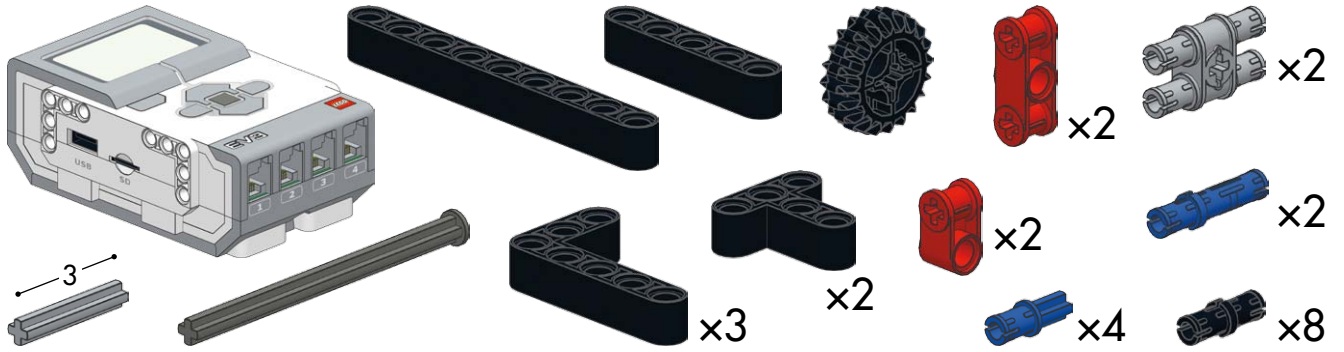



Ideas for using the color sensor

#174

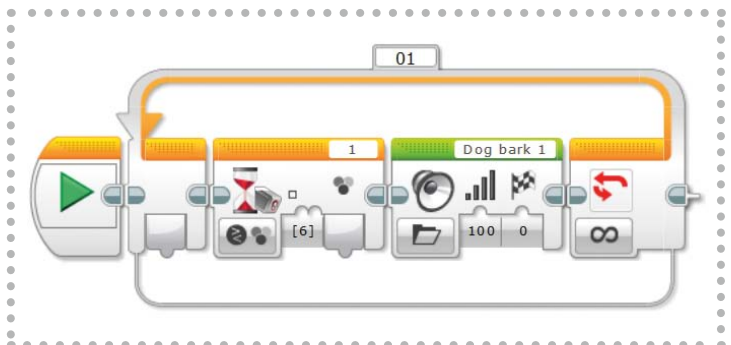
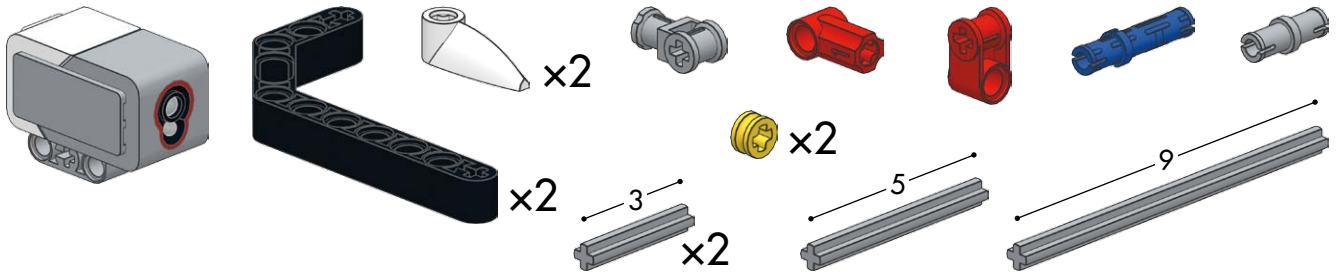

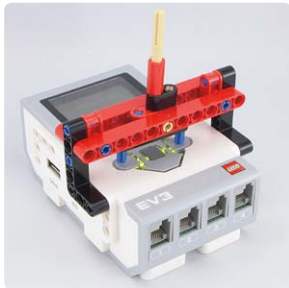

PART 6

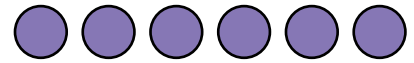

Something Extra



220



222



219

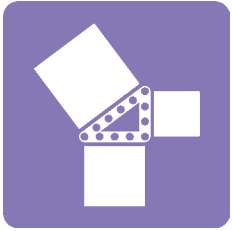

Using the Pythagorean theorem

#176

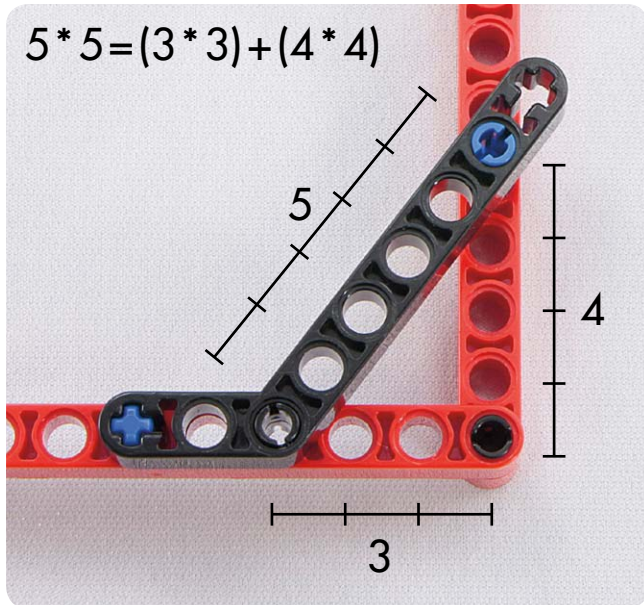

#177

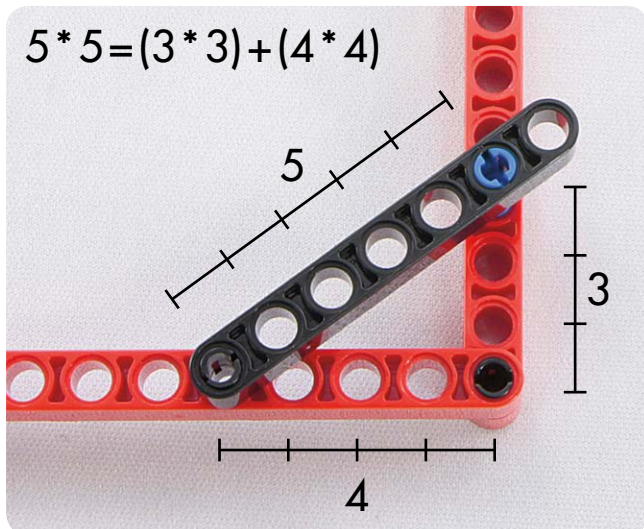

#178

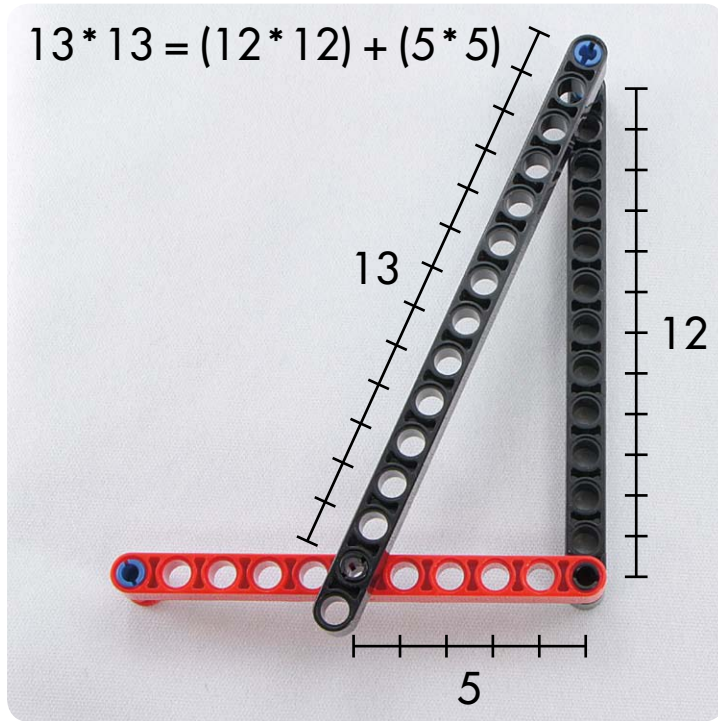

#179

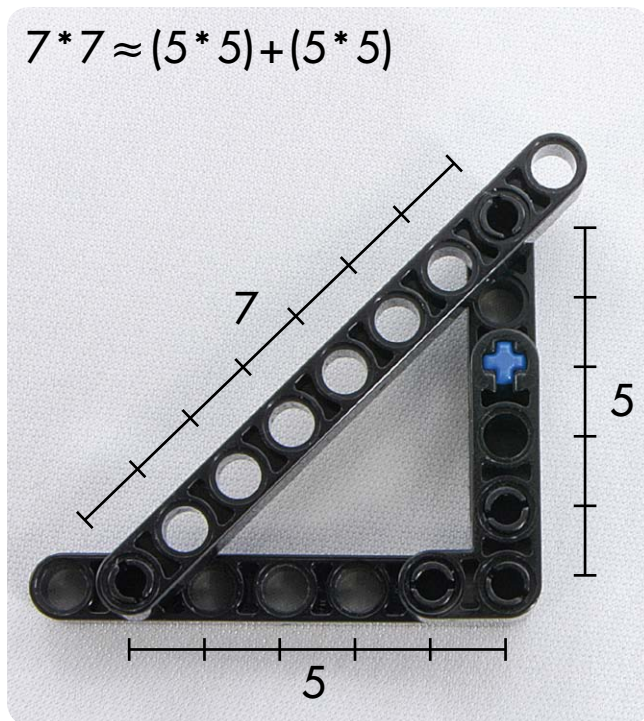

#180

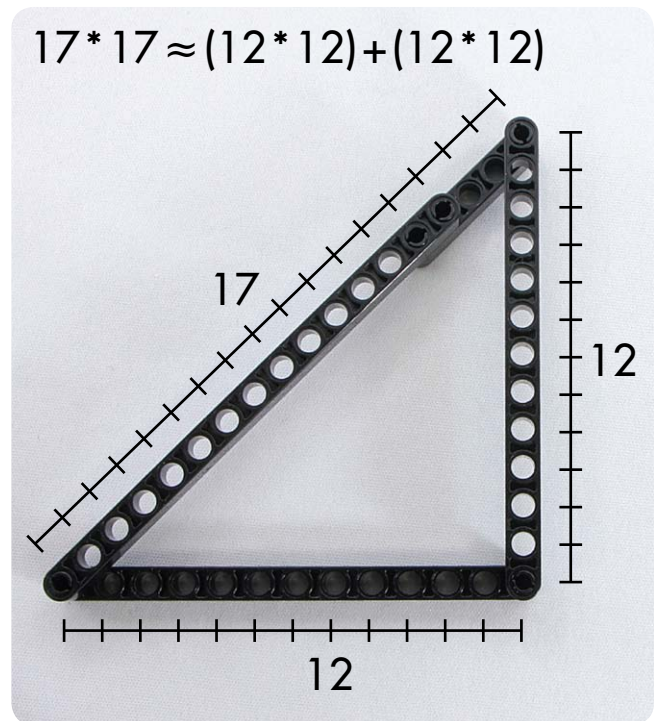

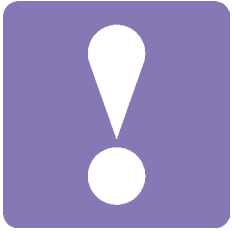

Try building something handy!

#181

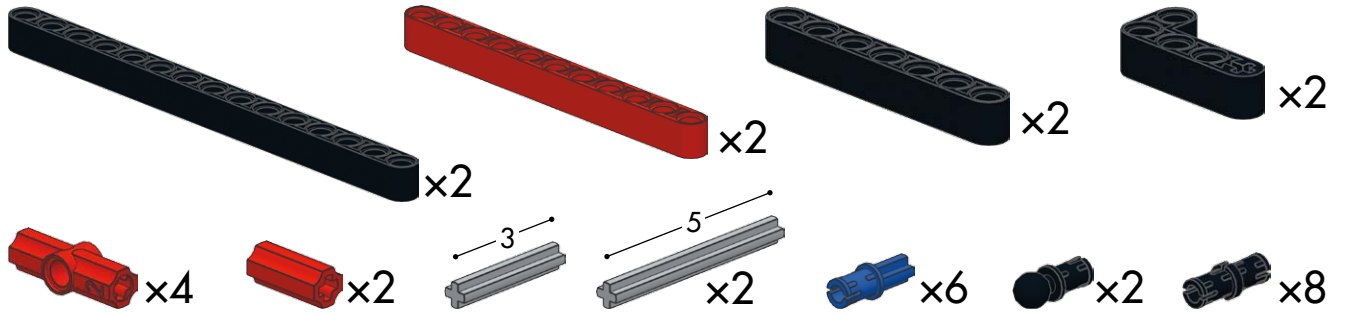



Updates

Visit <http://www.nostarch.com/ev3ideabook/> for updates, errata, and other information.

More no-nonsense books from  **no starch press**

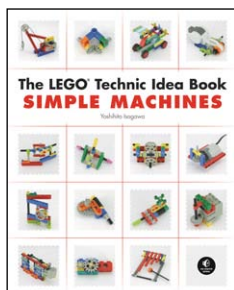

The LEGO® Technic Idea Book: Simple Machines

by YOSHIHITO ISOGAWA
OCTOBER 2010, 168 pp., \$19.95
ISBN 978-1-59327-277-7
full color



The LEGO® MINDSTORMS® EV3 Laboratory

Build, Program, and Experiment with Five Wicked Cool Robots!
by DANIELE BENEDETTI
OCTOBER 2013, 432 pp., \$34.95
ISBN 978-1-59327-533-4



The LEGO® MINDSTORMS® EV3 Discovery Book

A Beginner's Guide to Building and Programming Robots
by LAURENS VALK
JUNE 2014, 396 pp., \$34.95
ISBN 978-1-59327-532-7
full color

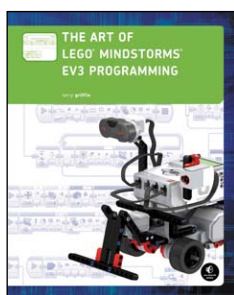

The Art of LEGO® MINDSTORMS® EV3 Programming

by TERRY GRIFFIN
SEPTEMBER 2014, 250 pp., \$34.95
ISBN 978-1-59327-568-6
full color



Incredible LEGO® Technic Cars, Trucks, Robots & More!

by PAWEŁ "SARIEL" KMIEĆ
FALL 2014, 280 pp., \$29.95
ISBN 978-1-59327-587-7
full color

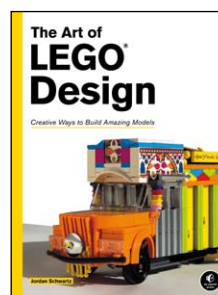

The Art of LEGO® Design Creative Ways to Build Amazing Models

by JORDAN SCHWARTZ
JUNE 2014, 288 pp., \$24.95
ISBN 978-1-59327-553-2
full color

800.420.7240 or 415.863.9900 | sales@nostarch.com | www.nostarch.com

Imagine. Create. Invent.

Now, What Will You Build?

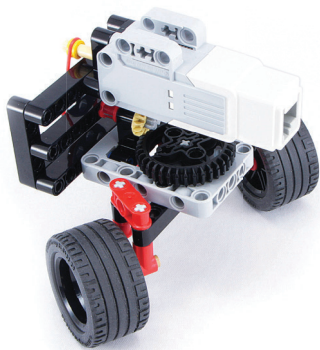

The *LEGO® MINDSTORMS® EV3 Idea Book* explores dozens of creative ways to build amazing mechanisms with the LEGO MINDSTORMS EV3 set. Each model includes a list of the required parts, minimal text, and colorful photographs from multiple angles so you can re-create it without the need for step-by-step instructions.

You'll learn to build cars with real suspension, steerable crawlers, ball-shooters, grasping robotic arms, and other creative marvels. Each model demonstrates simple mechanical principles that you can use as building blocks for your own creations.

Best of all, every part you need to build these machines comes in one LEGO set (#31313)!

ABOUT THE AUTHOR

Yoshihito Isogawa is a LEGO luminary with 46 years of building experience. He is the author of the *LEGO Technic Idea Book* series (No Starch Press) as well as many Japanese-language LEGO books.



NO STARCH
PRESS

THE FINEST IN GEEK ENTERTAINMENT™
www.nostarch.com

THIS BOOK IS NOT AUTHORIZED OR
ENDORSED BY THE LEGO GROUP.

SHELVE IN: HOBBIES/LEGO

ISBN: 978-1-59327-600-3



9 781593 276003



5 2 4 9 5



6 89145 76001 9

\$24.95 (\$25.95 CDN)